

$w = e^z$ z -plane \longrightarrow w -plane

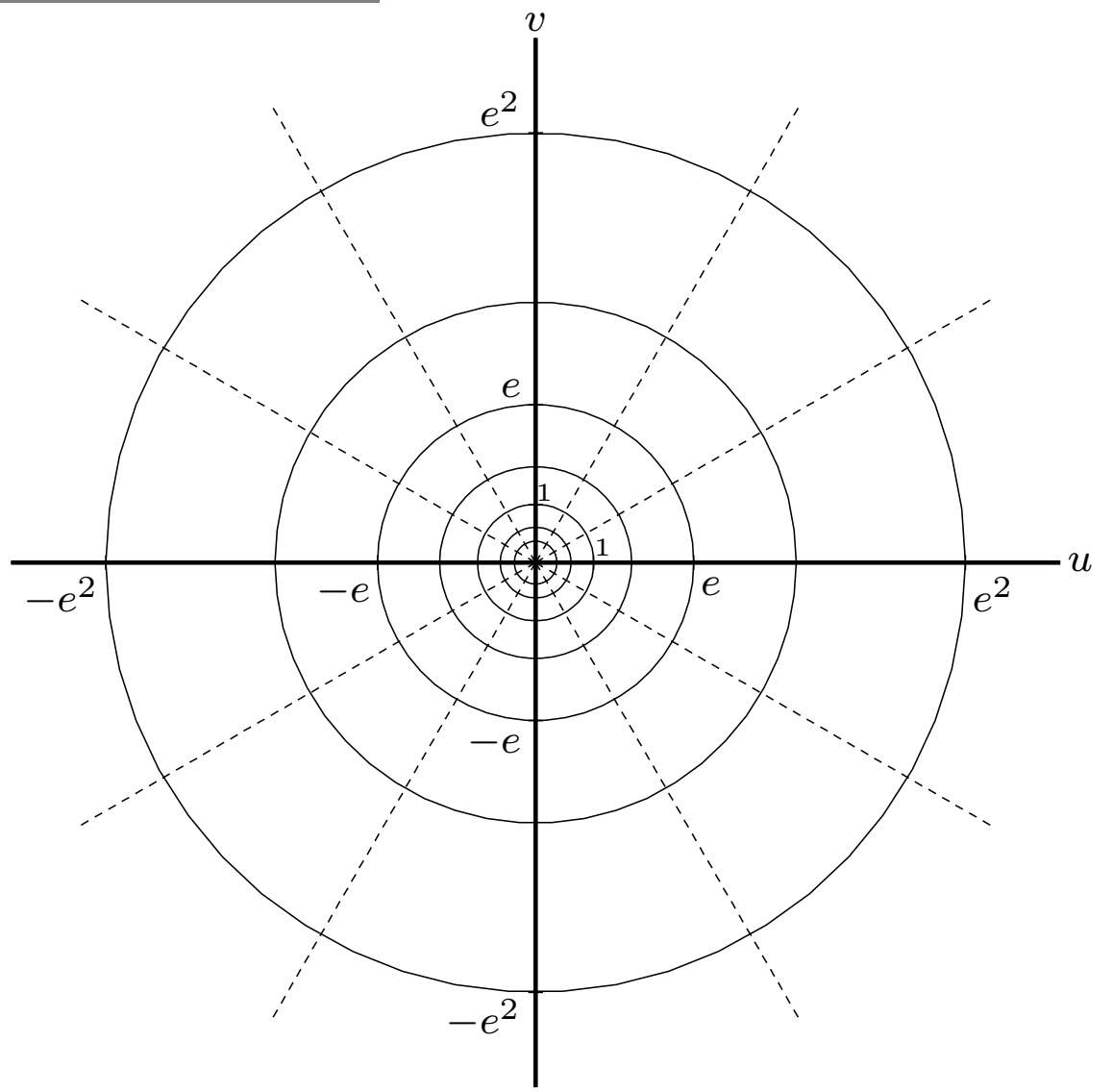

$w = e^z$ z -plane \longrightarrow w -plane

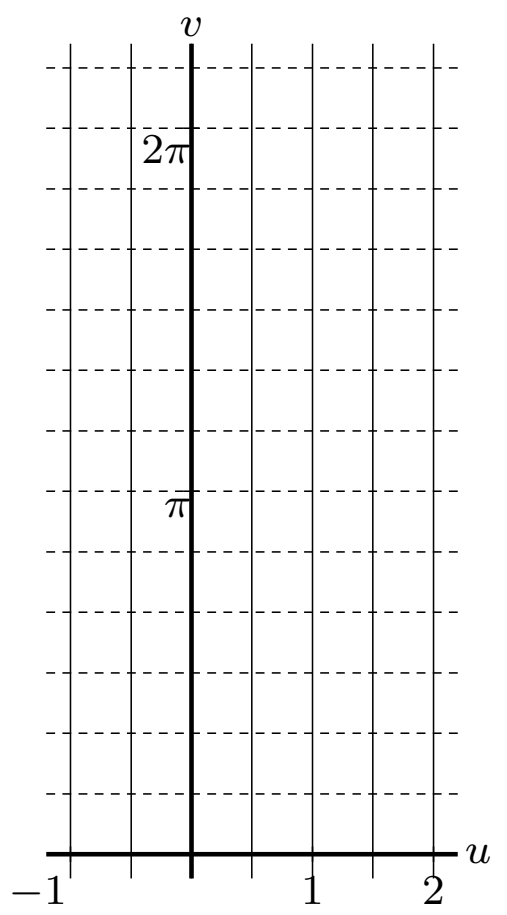
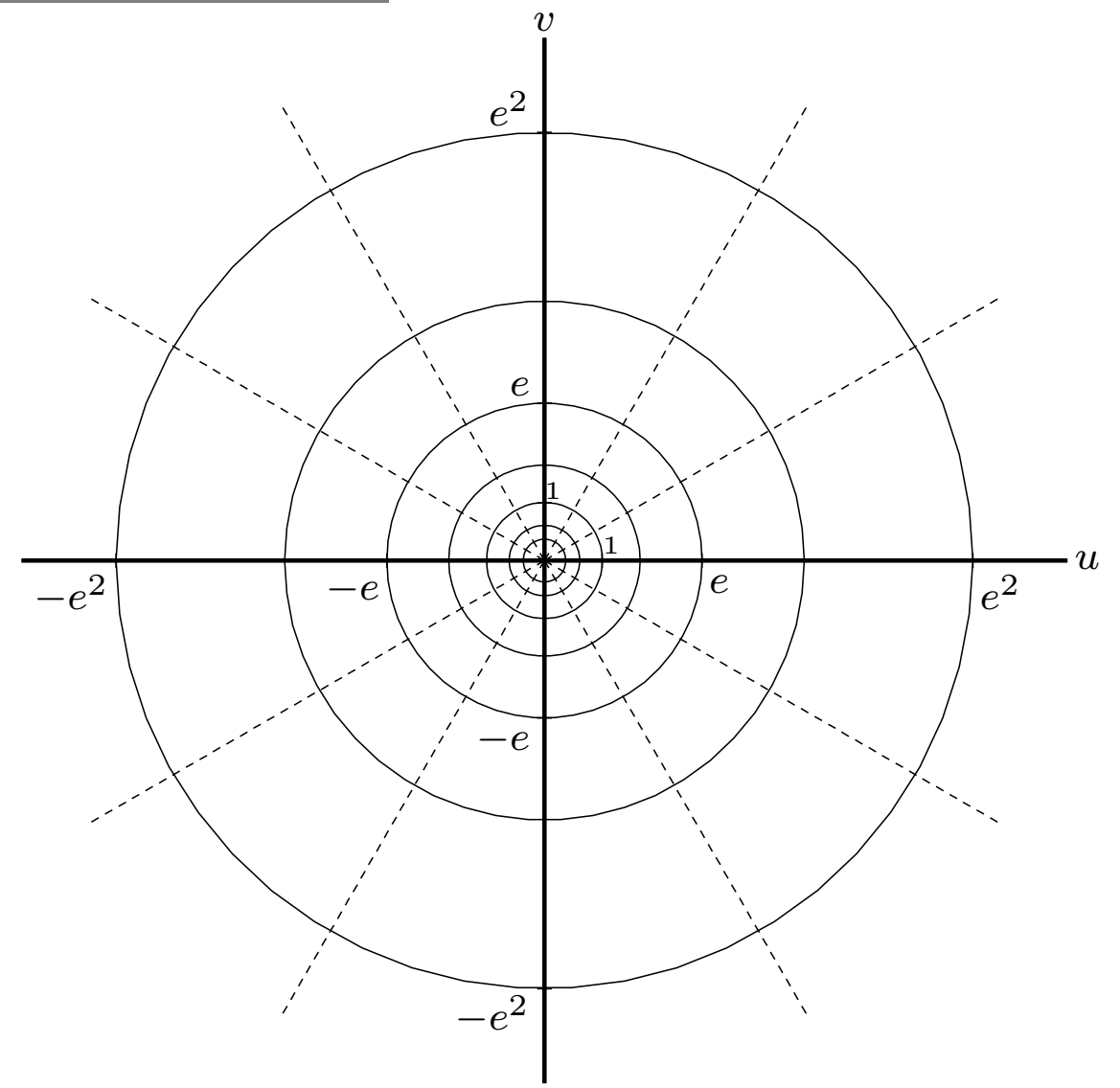
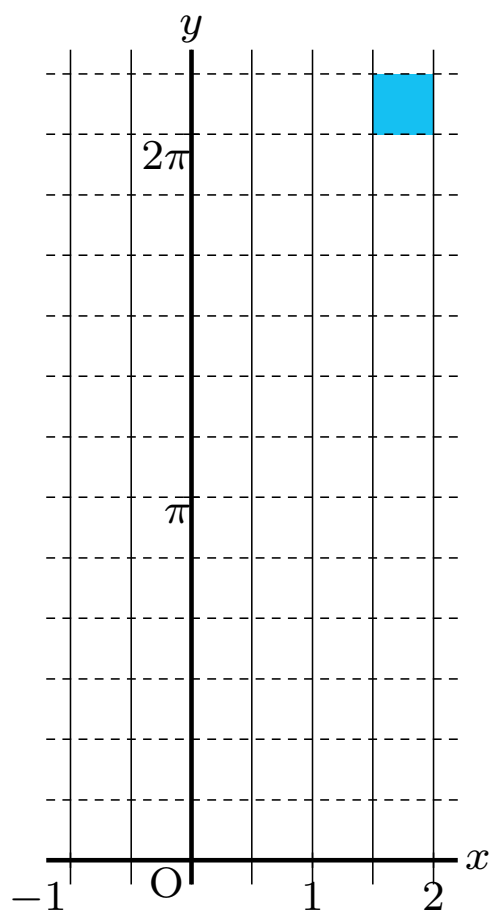

$w = e^z$ z -plane \longrightarrow w -plane

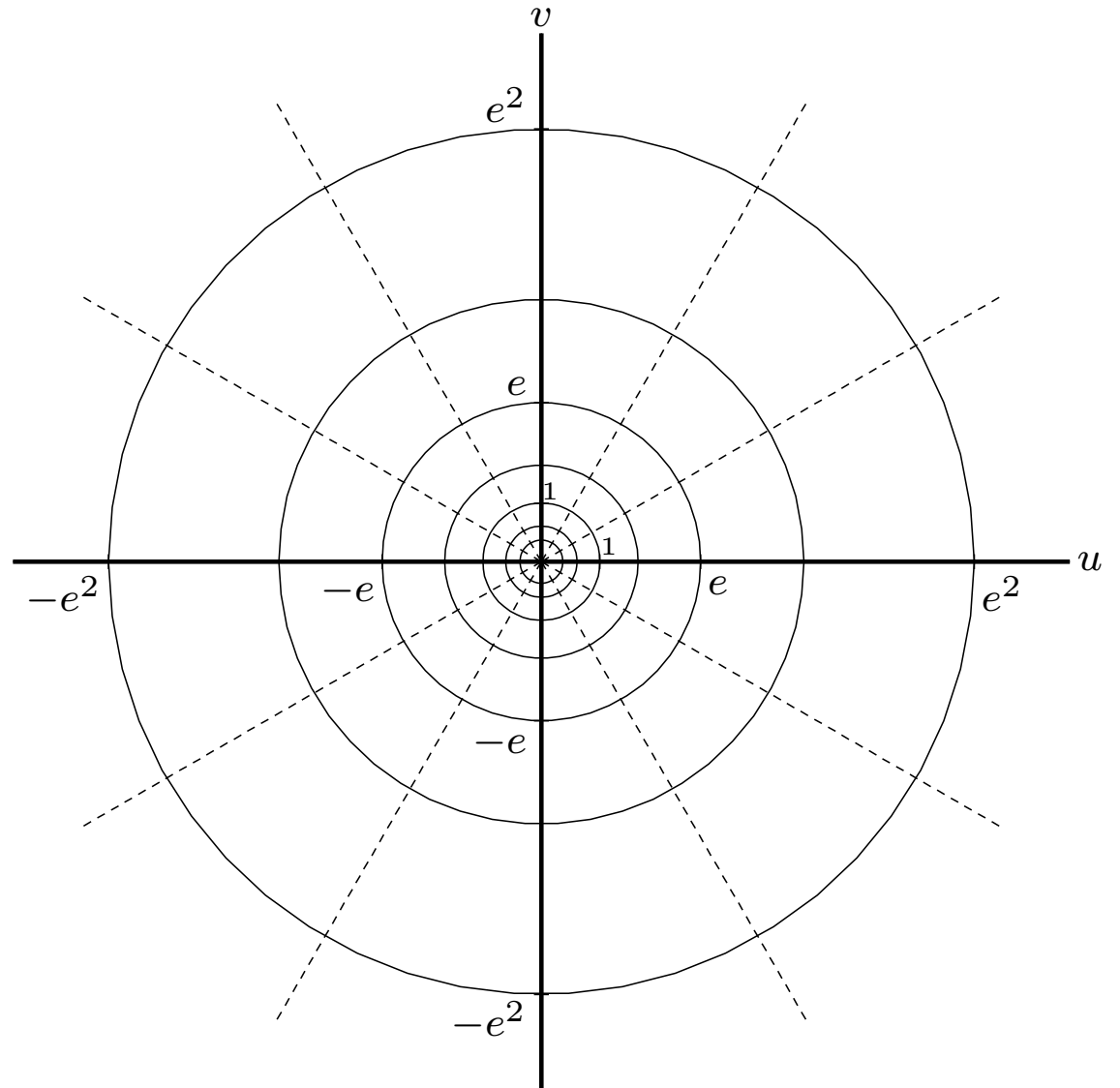
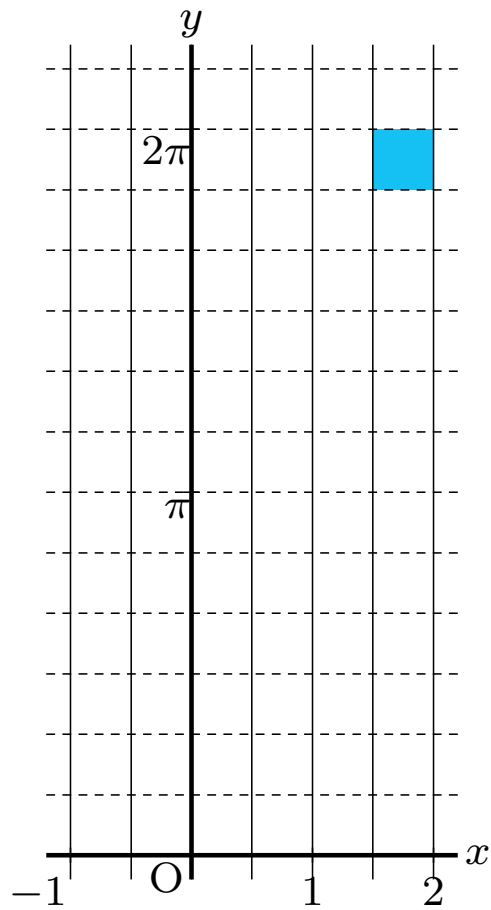

$w = e^z$ z -plane \longrightarrow w -plane

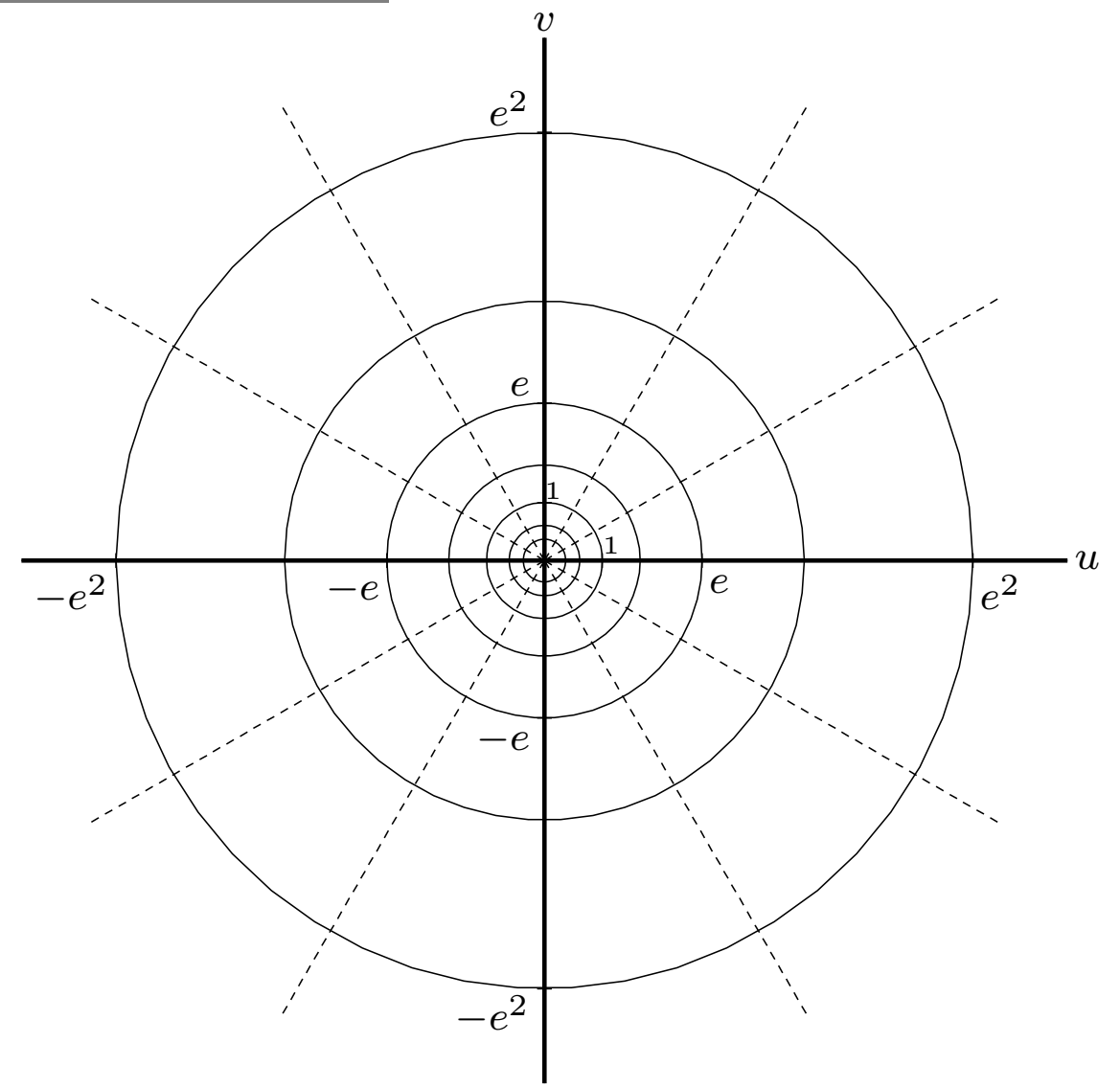
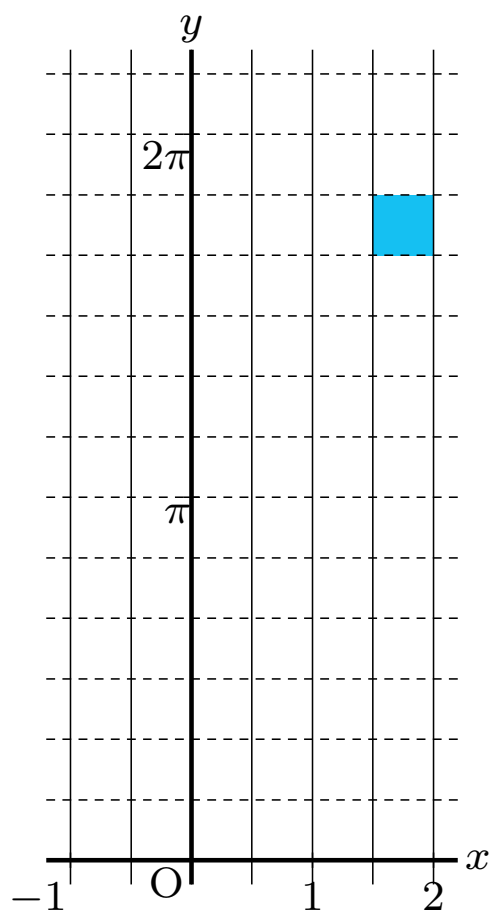

$w = e^z$ z -plane \longrightarrow w -plane

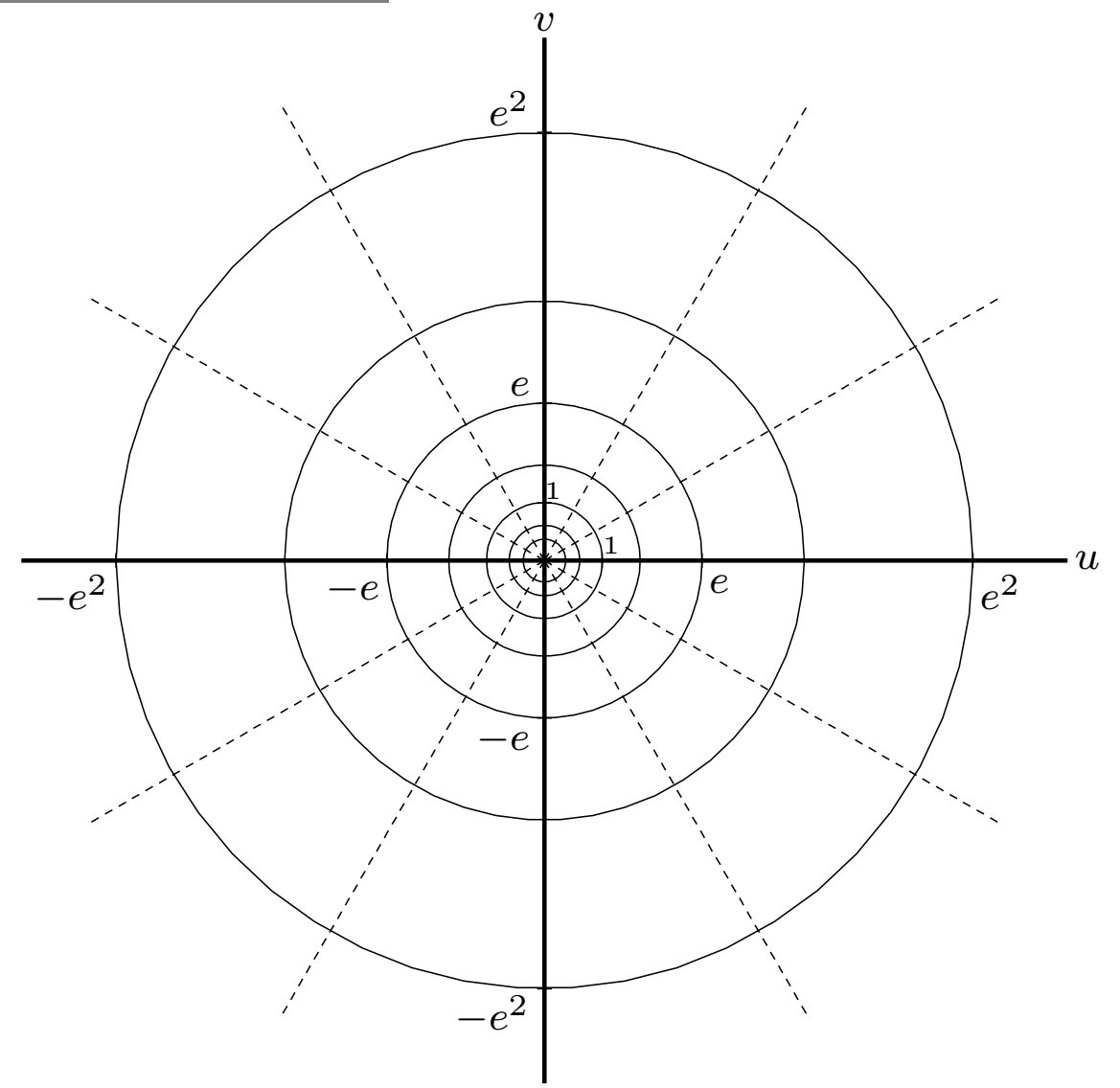
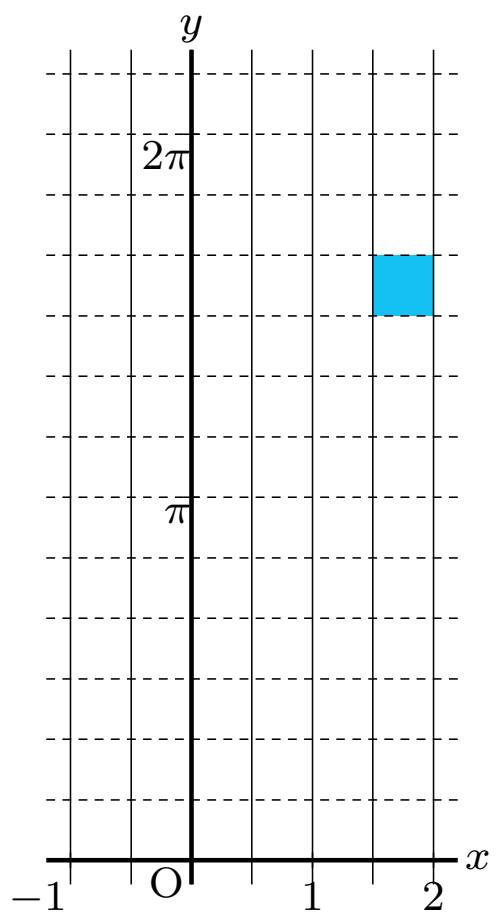

$w = e^z$ z -plane \longrightarrow w -plane

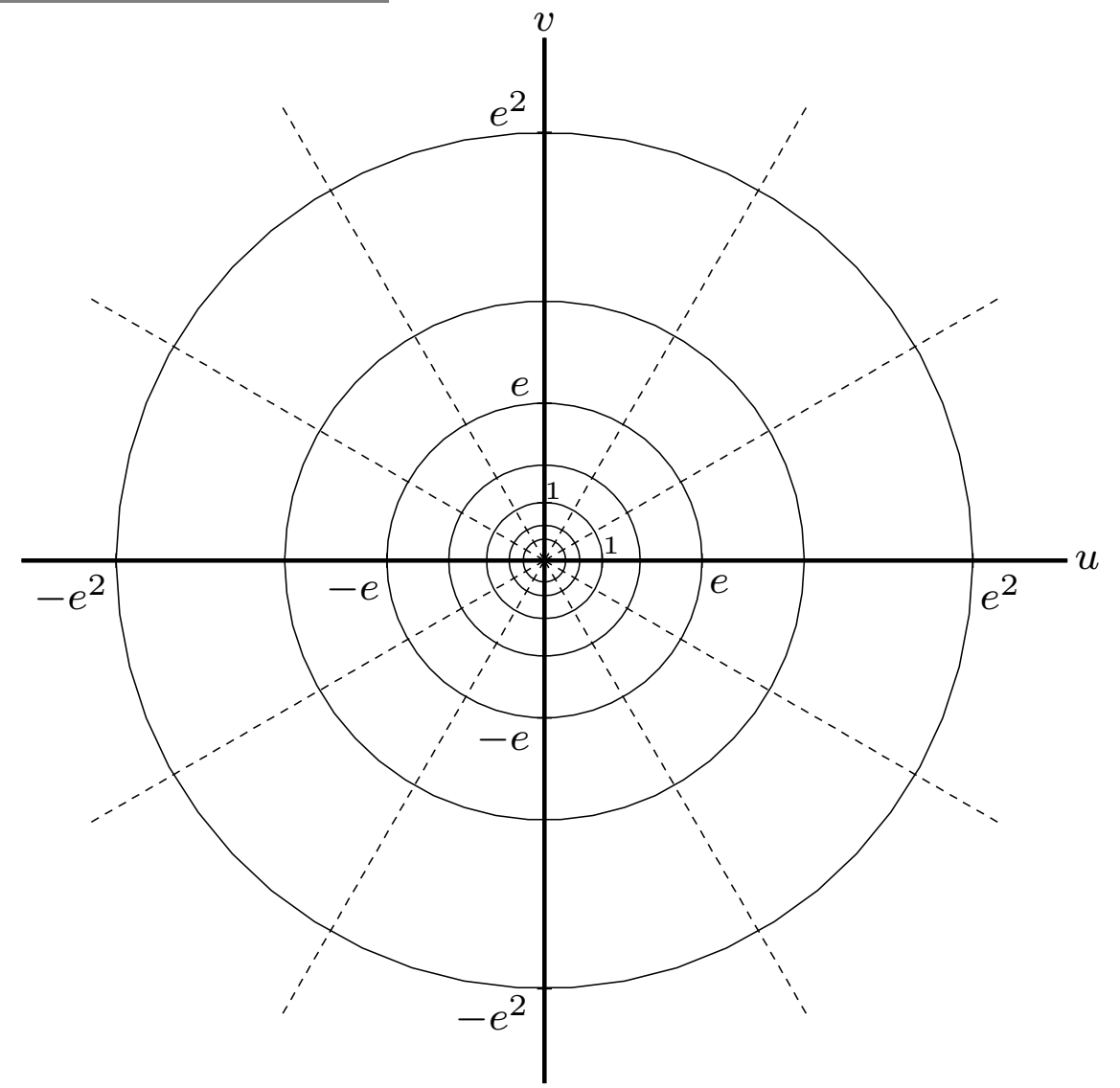
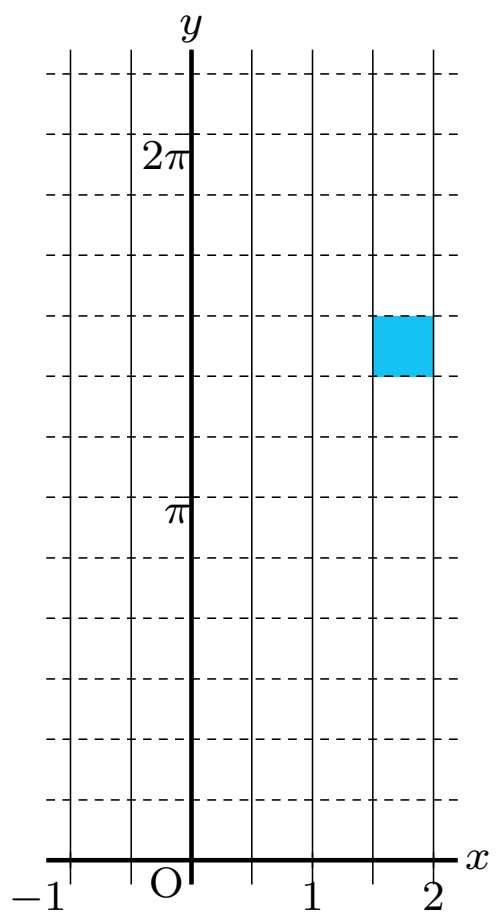

$w = e^z$ z -plane \longrightarrow w -plane

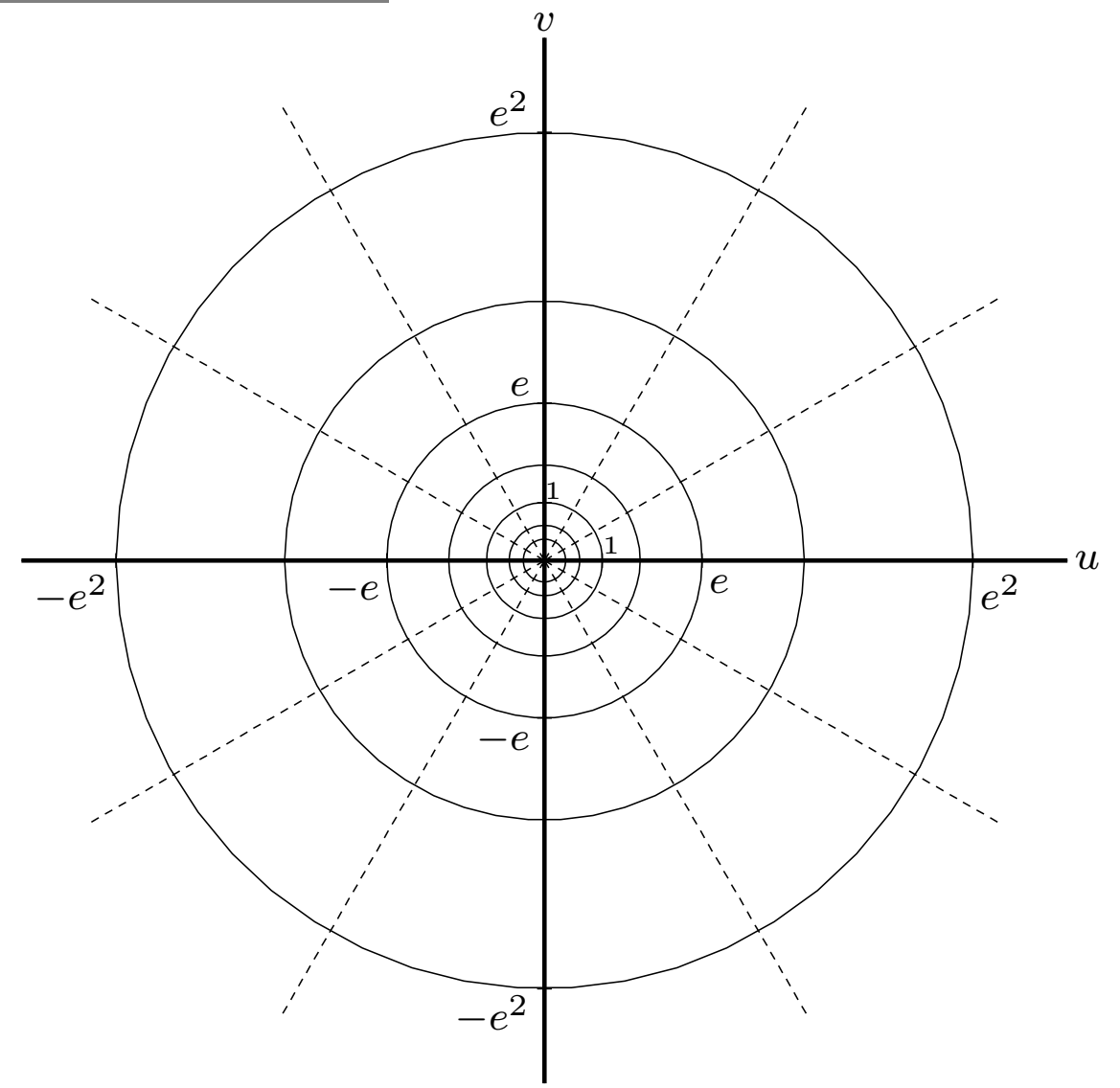
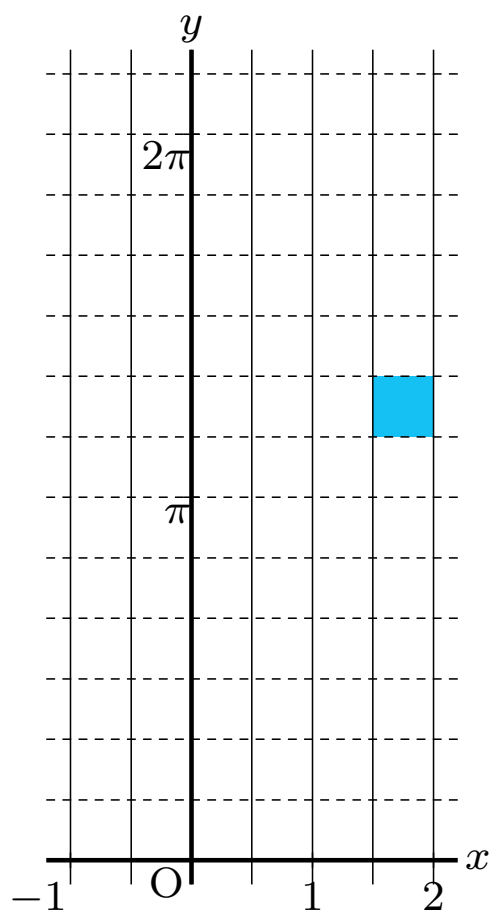

$w = e^z$ z -plane \longrightarrow w -plane

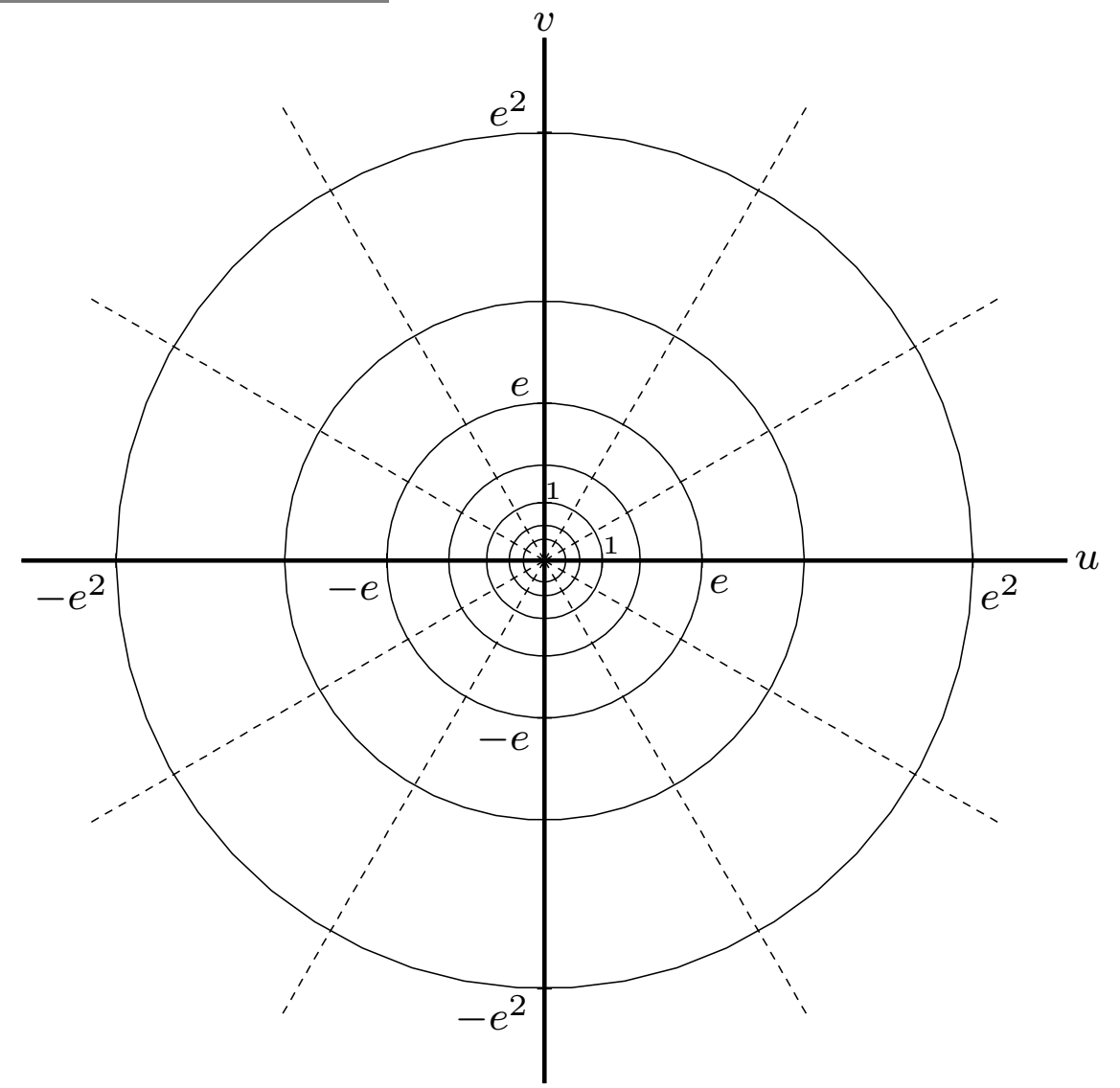
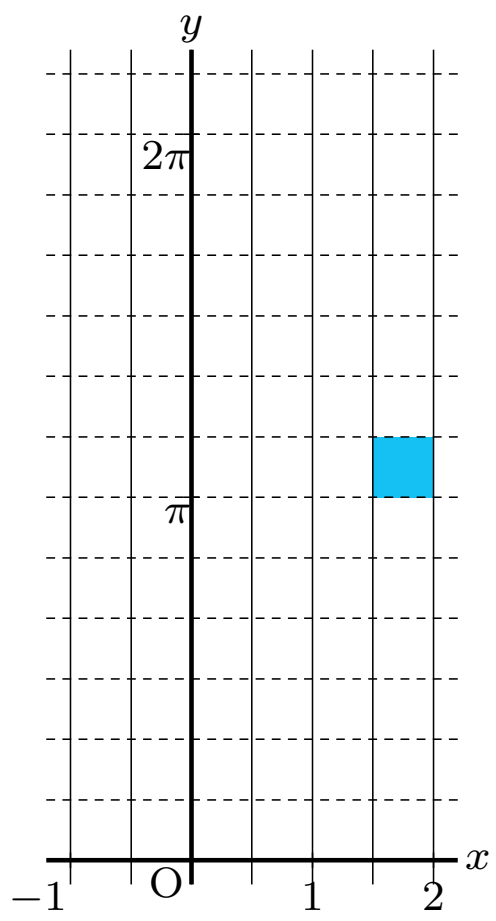

$w = e^z$ z -plane \longrightarrow w -plane

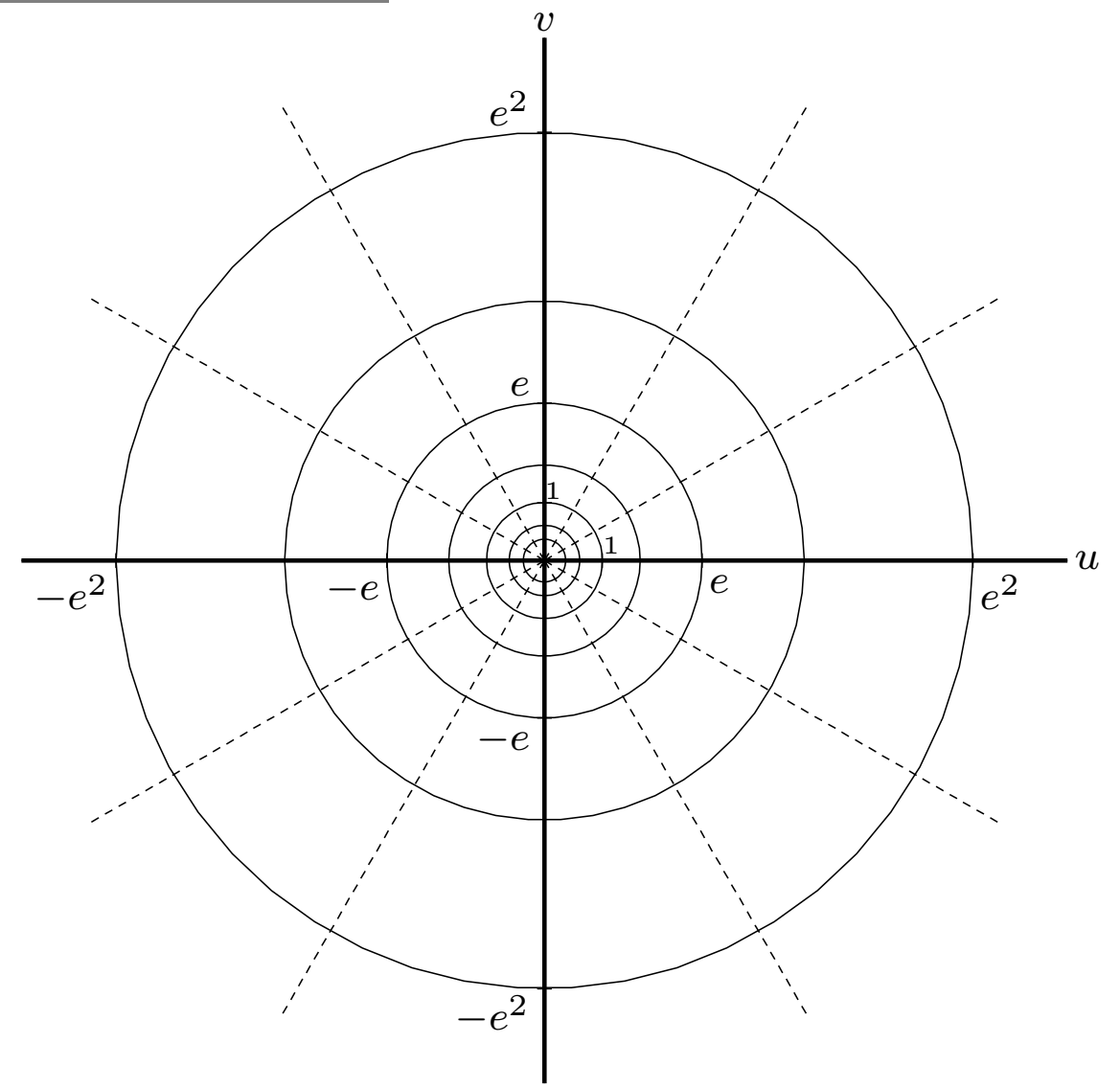
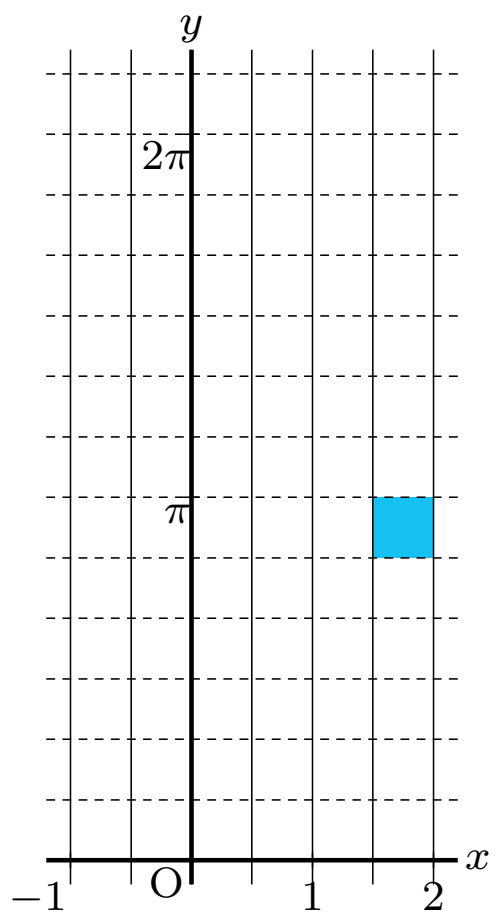

$w = e^z$ z -plane \longrightarrow w -plane

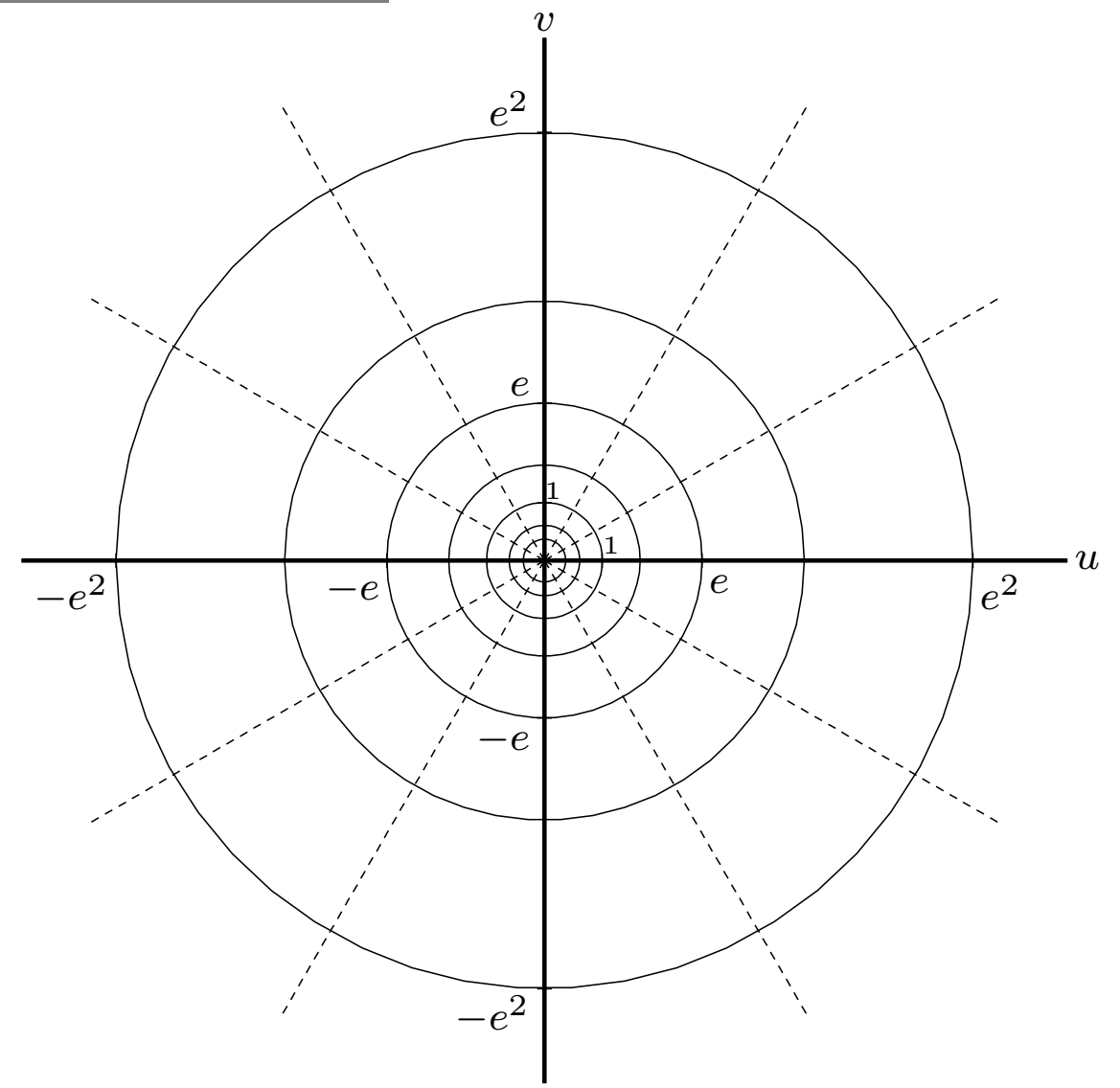
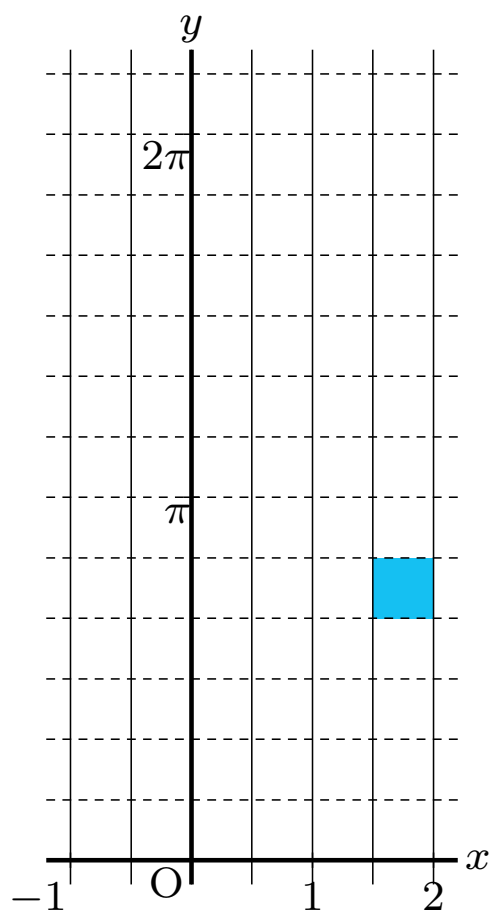

$w = e^z$ z -plane \longrightarrow w -plane

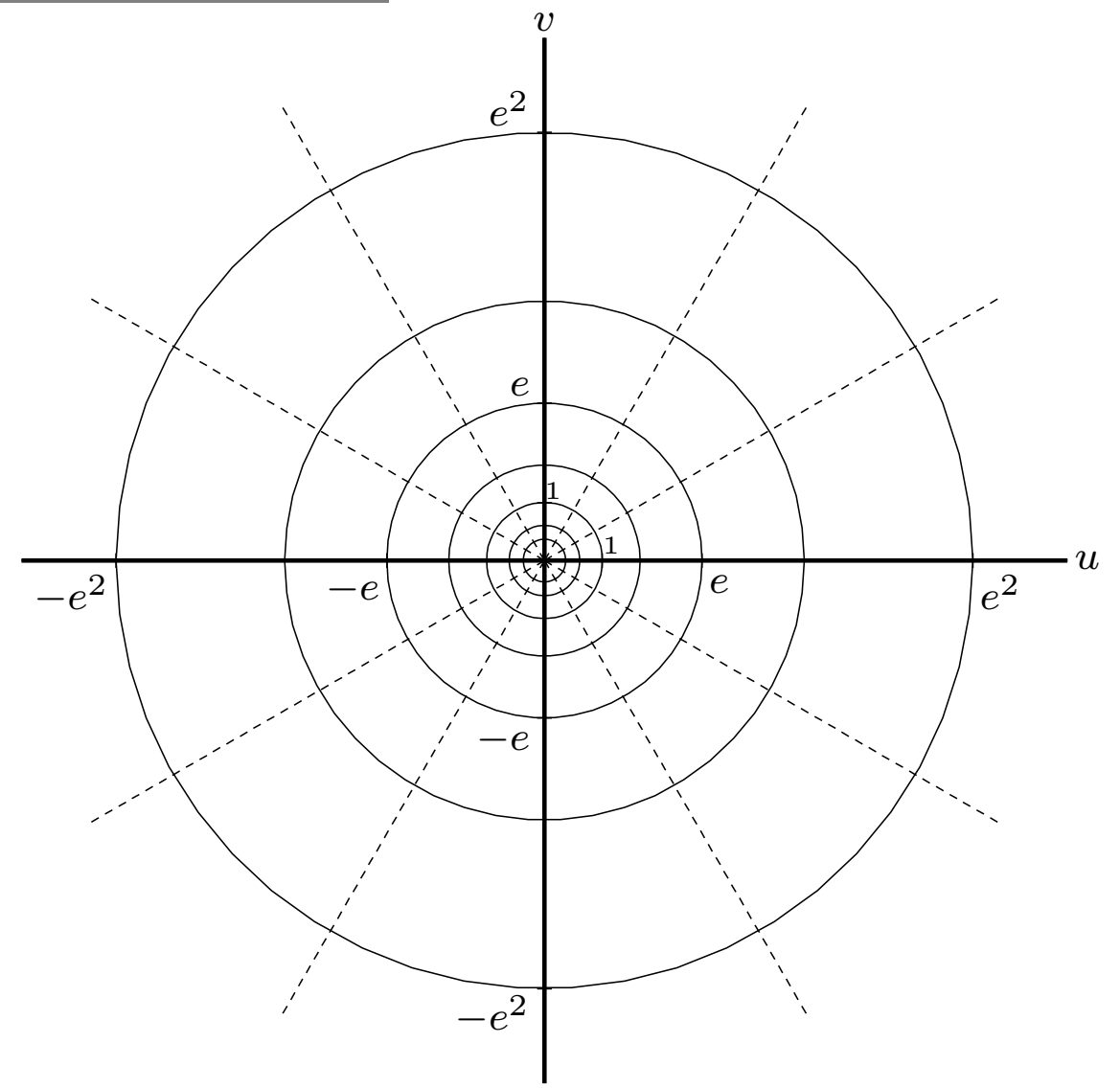
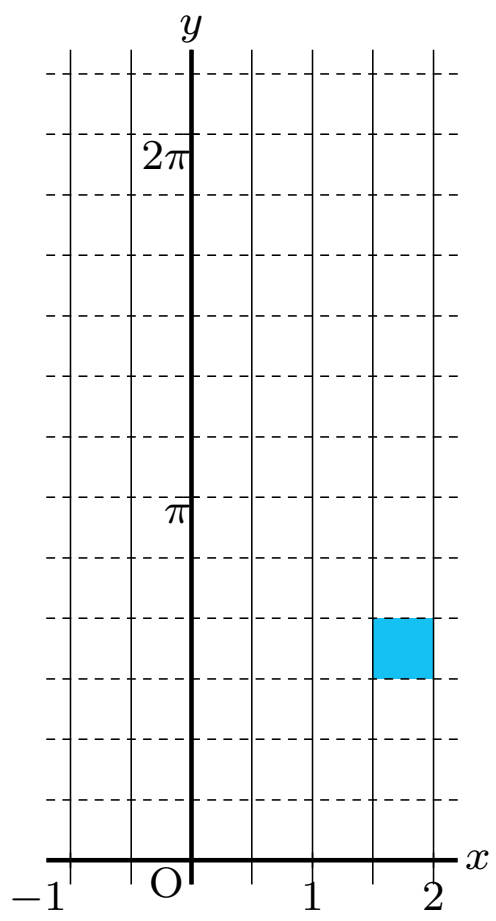

$w = e^z$ z -plane \longrightarrow w -plane

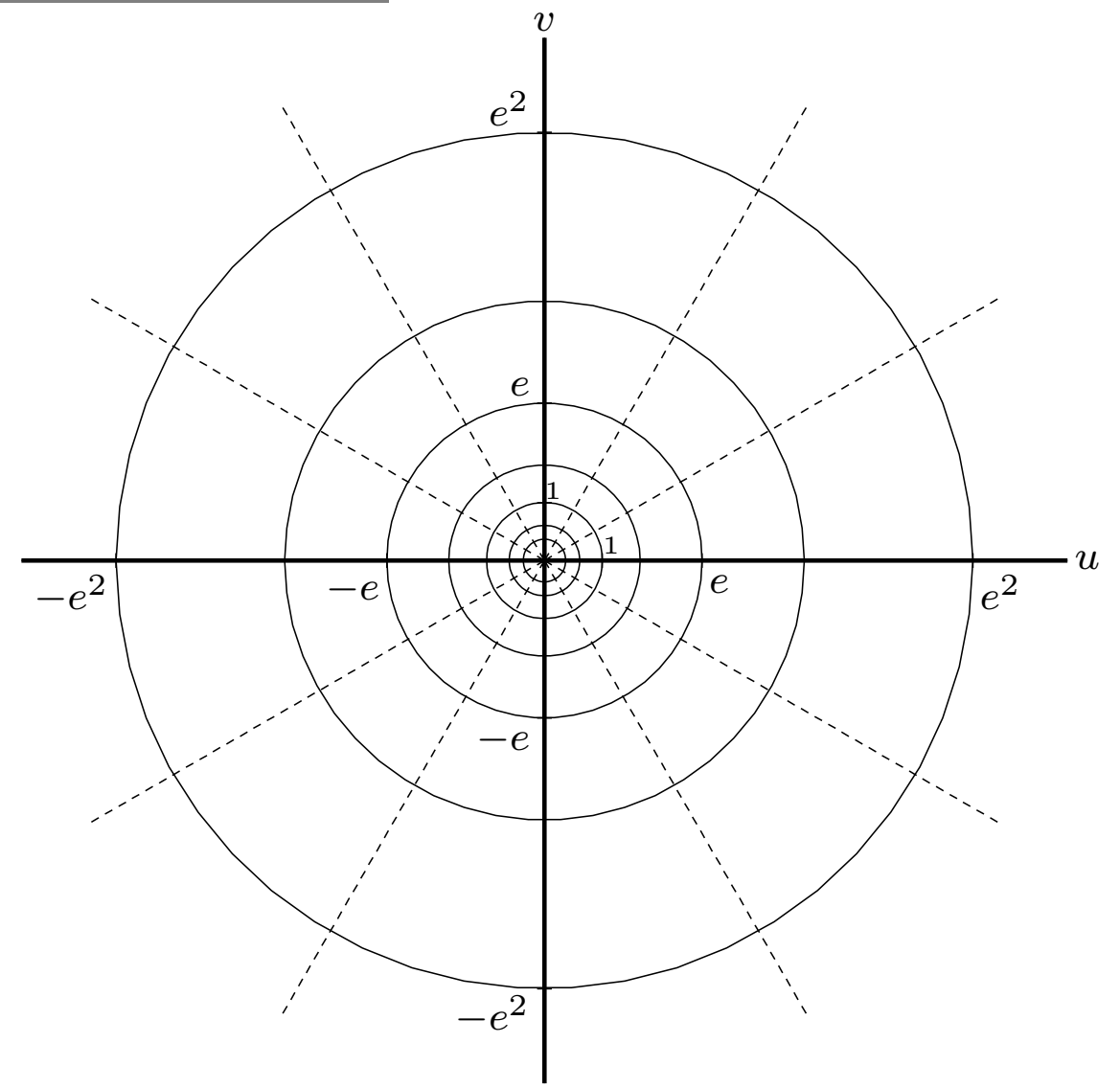
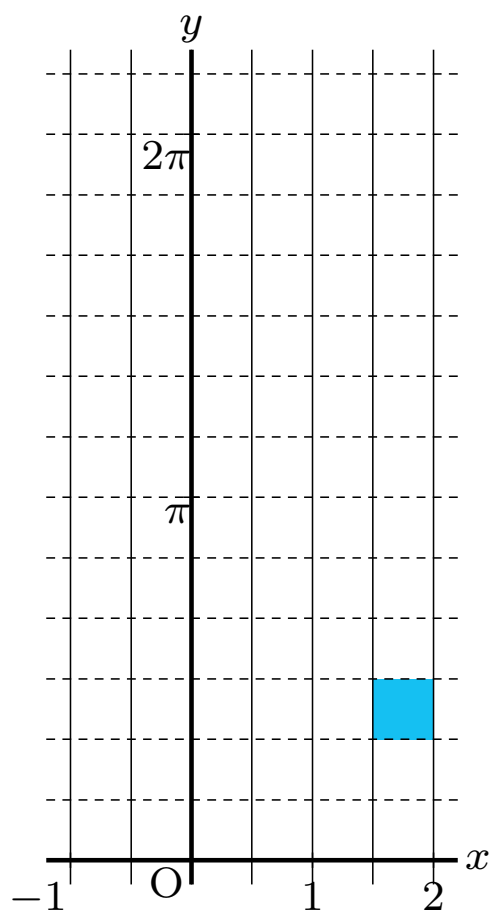

$w = e^z$ z -plane \longrightarrow w -plane

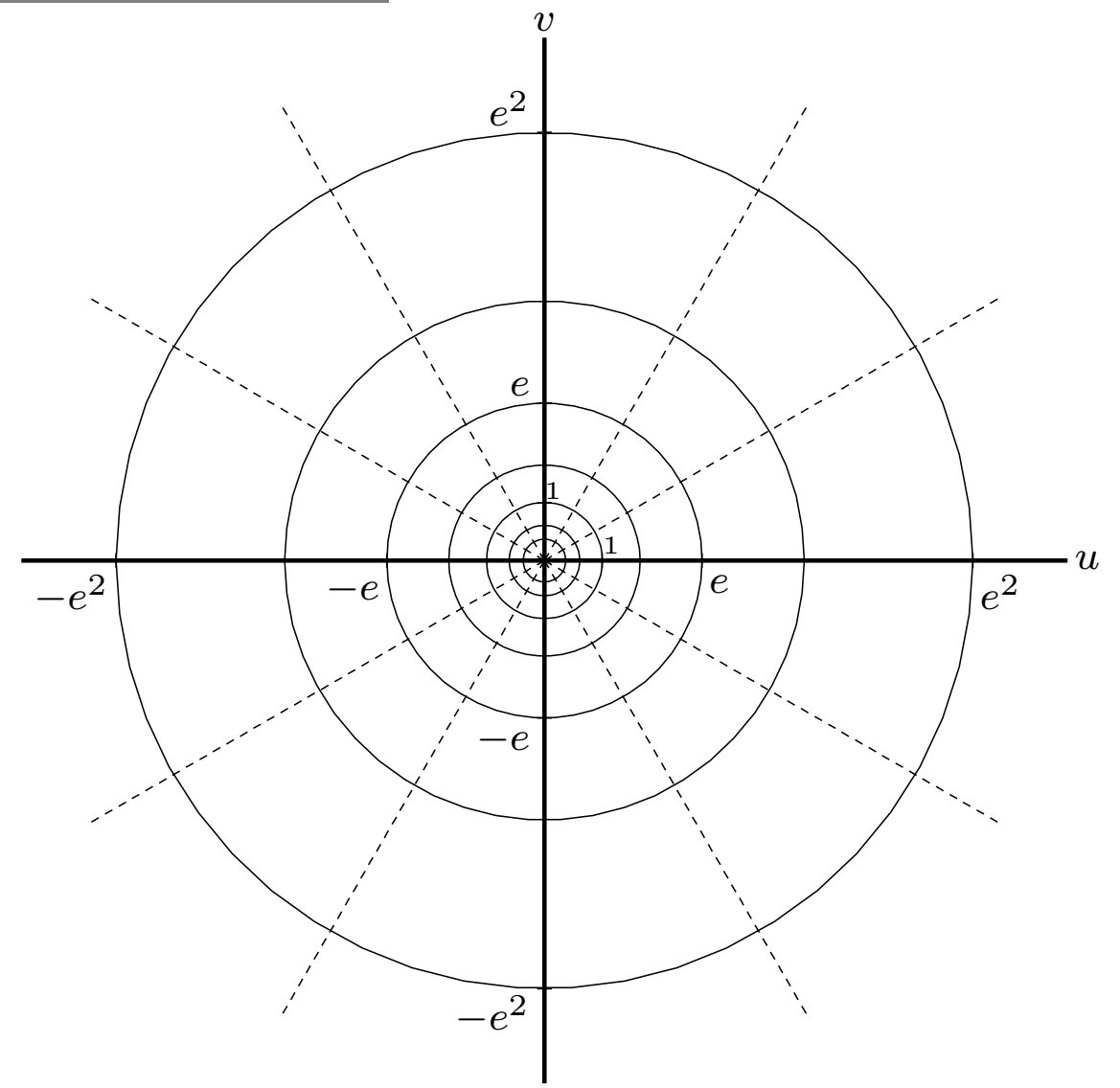
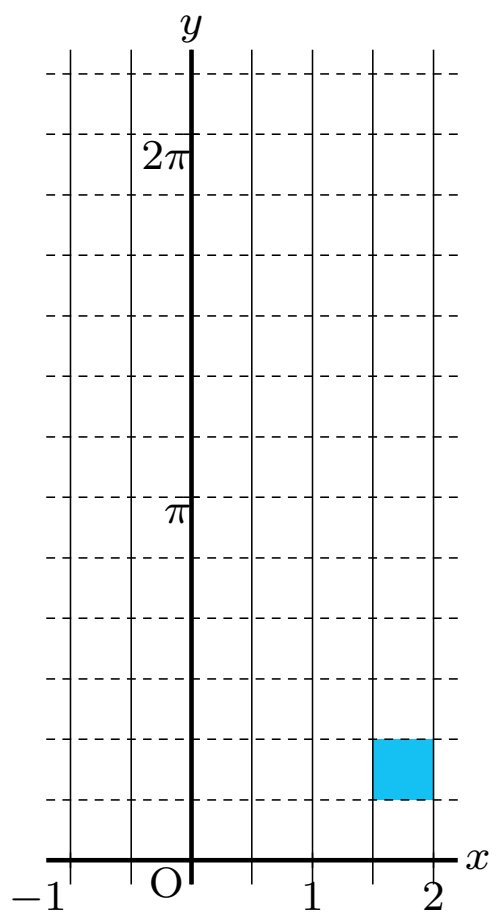

$w = e^z$ z -plane \longrightarrow w -plane

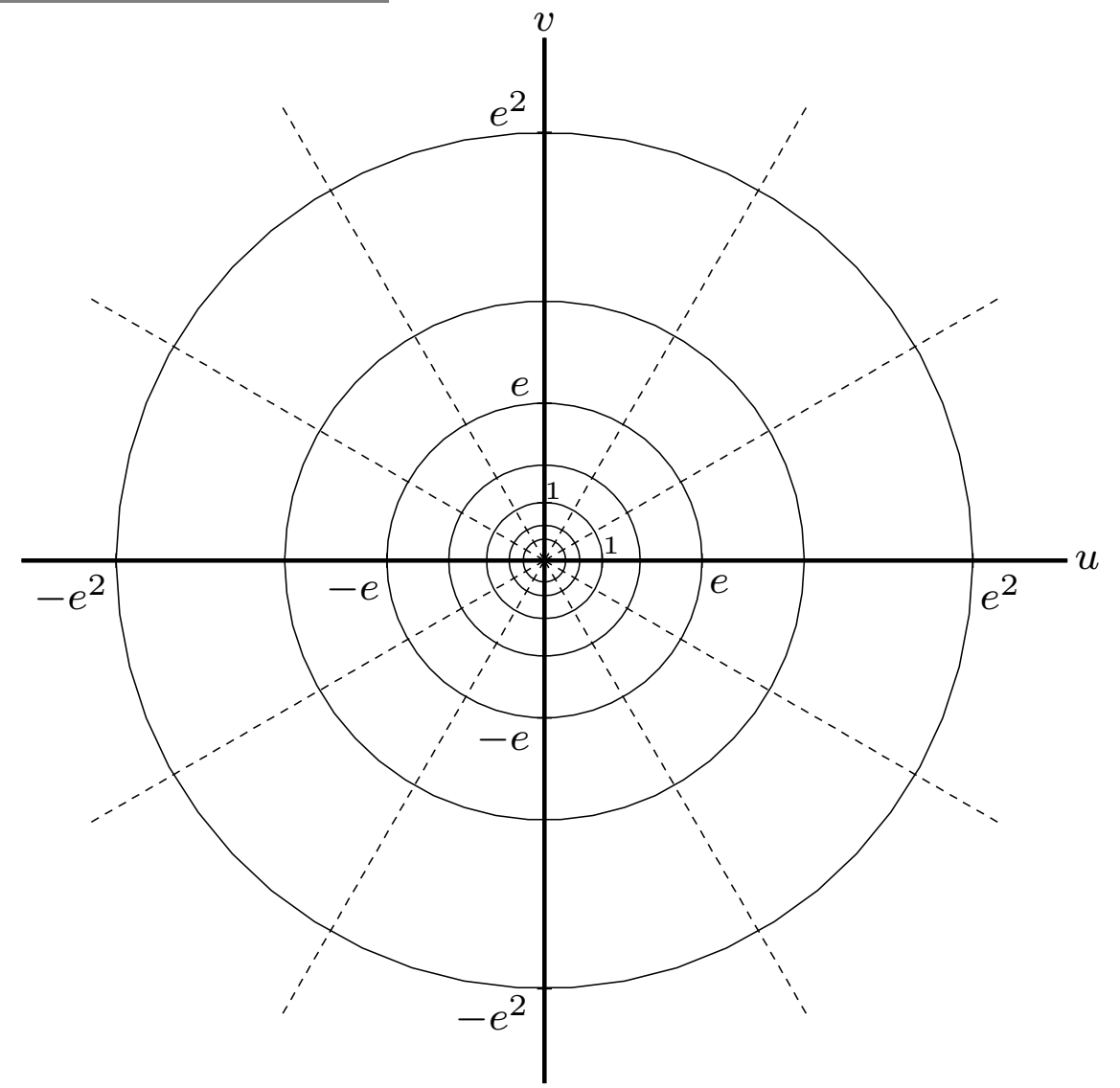
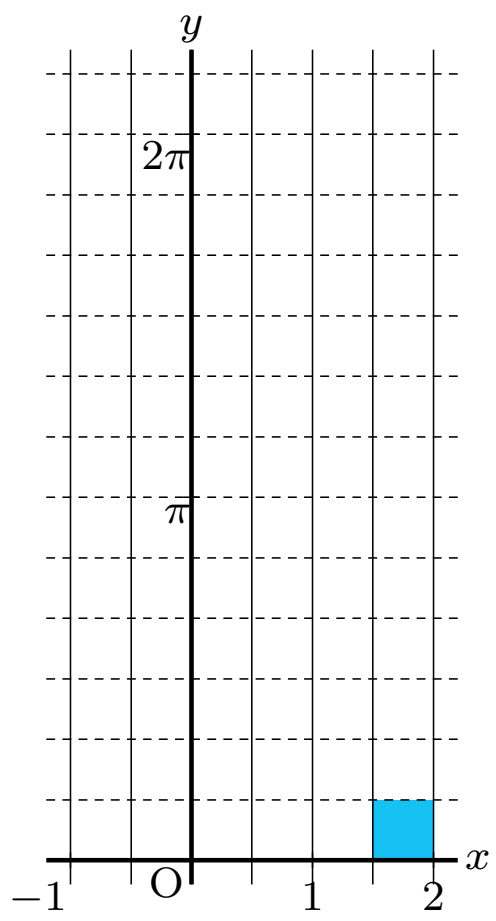

$w = e^z$ z -plane \longrightarrow w -plane

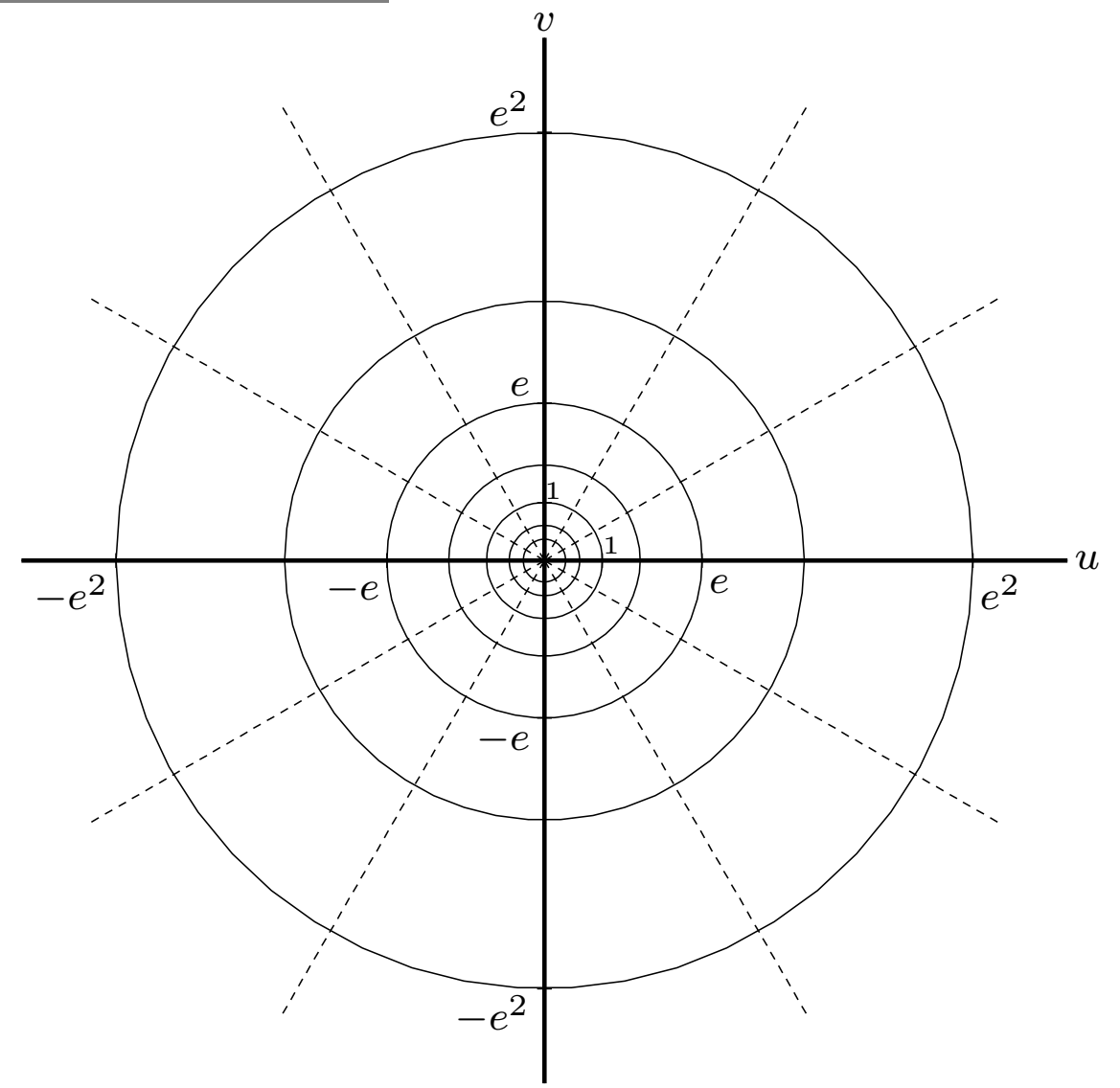
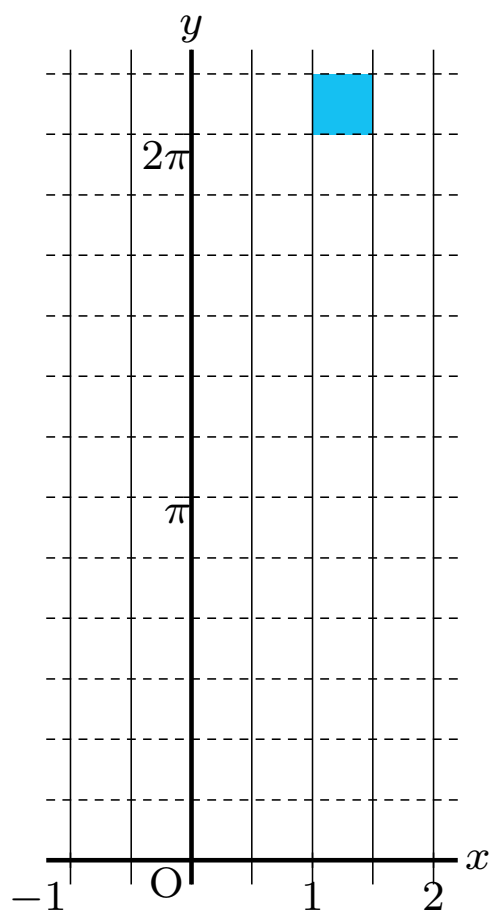

$w = e^z$ z -plane \longrightarrow w -plane

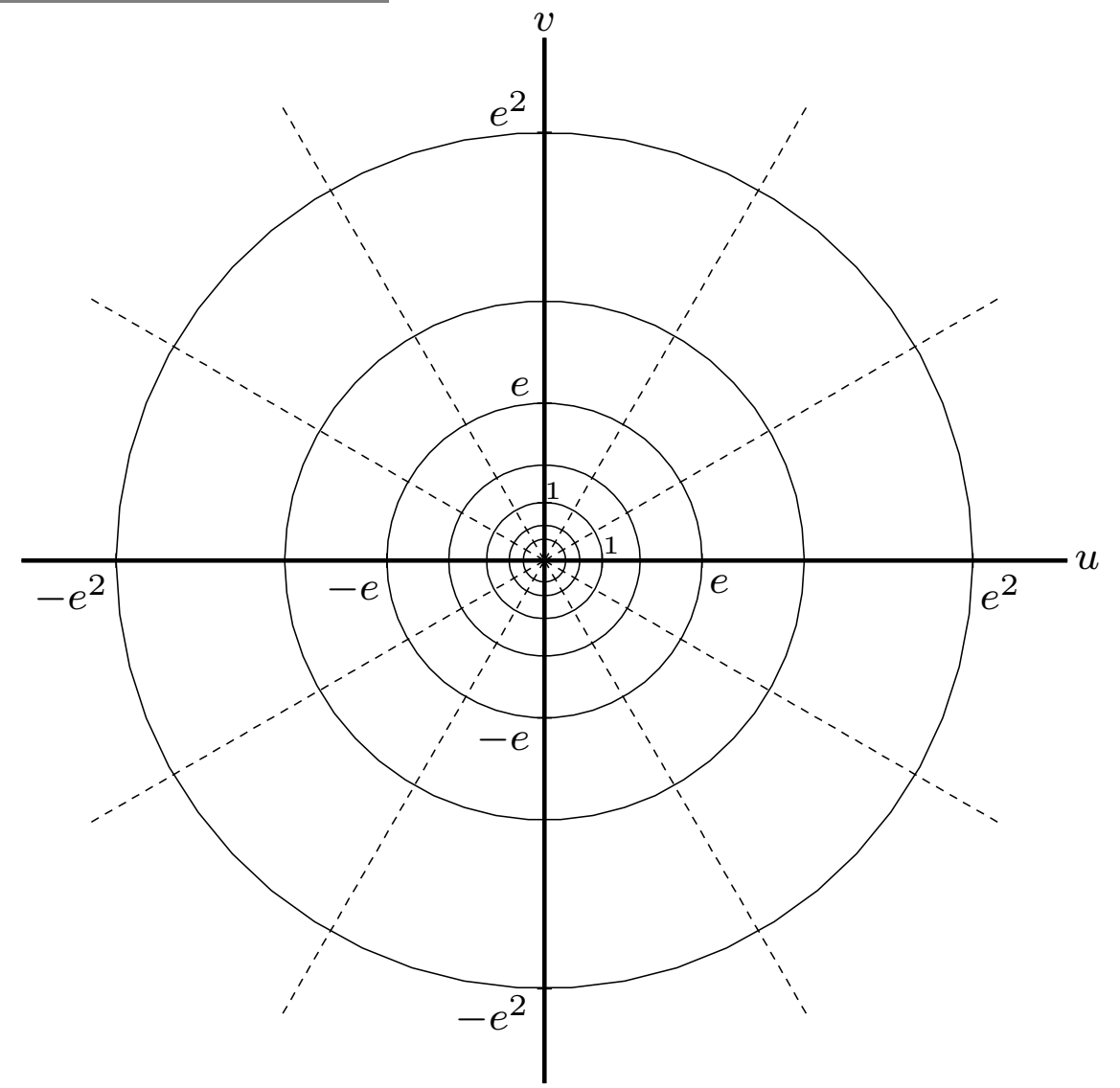
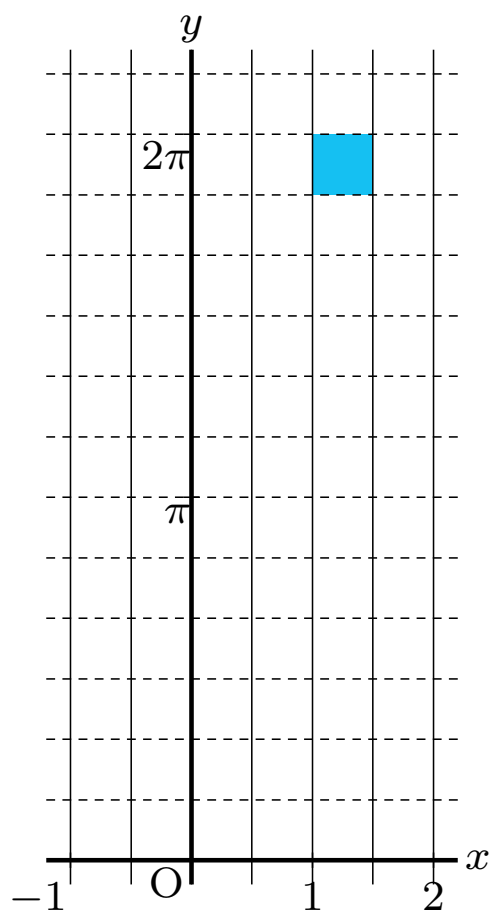

$w = e^z$ z -plane \longrightarrow w -plane

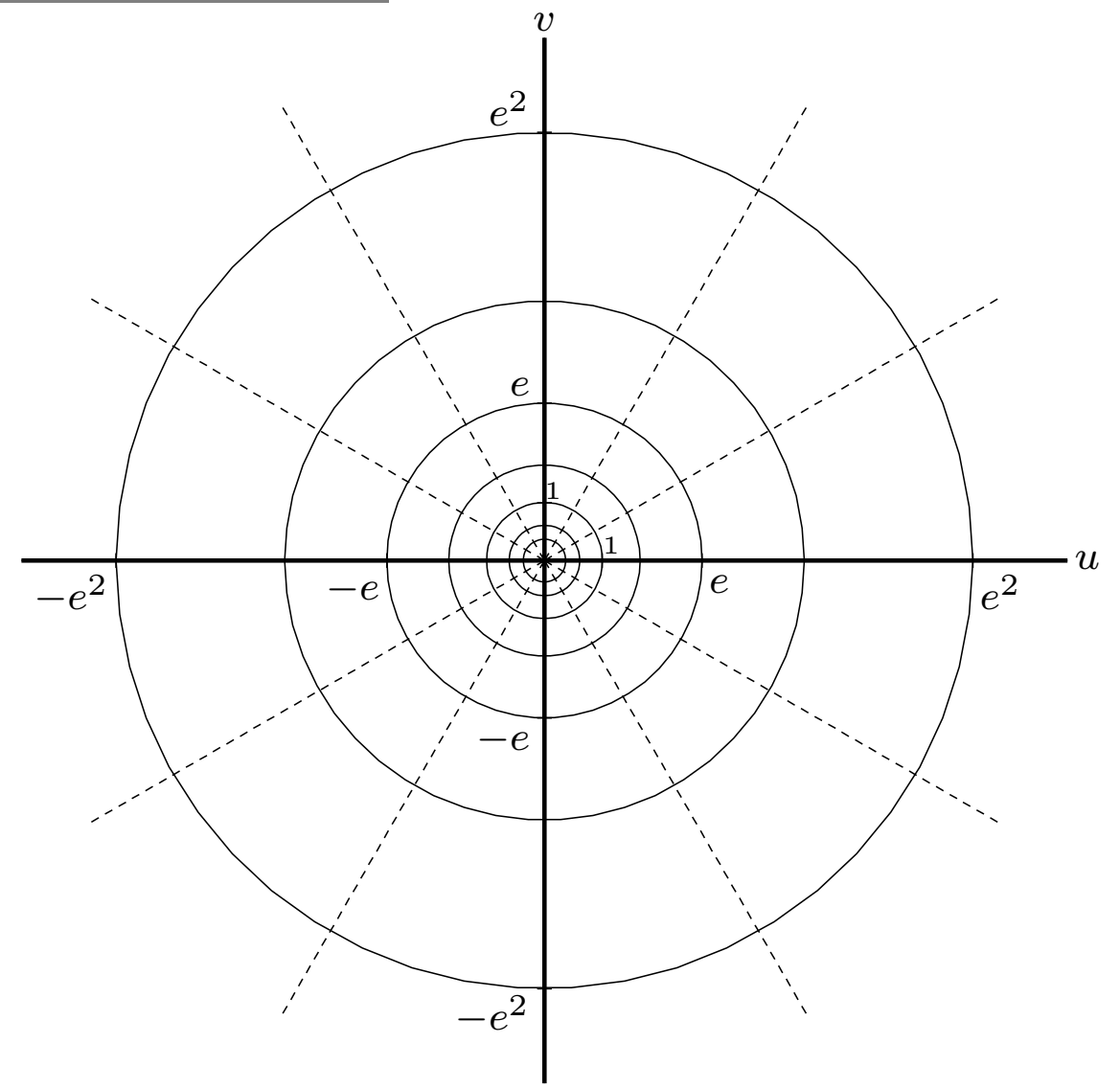
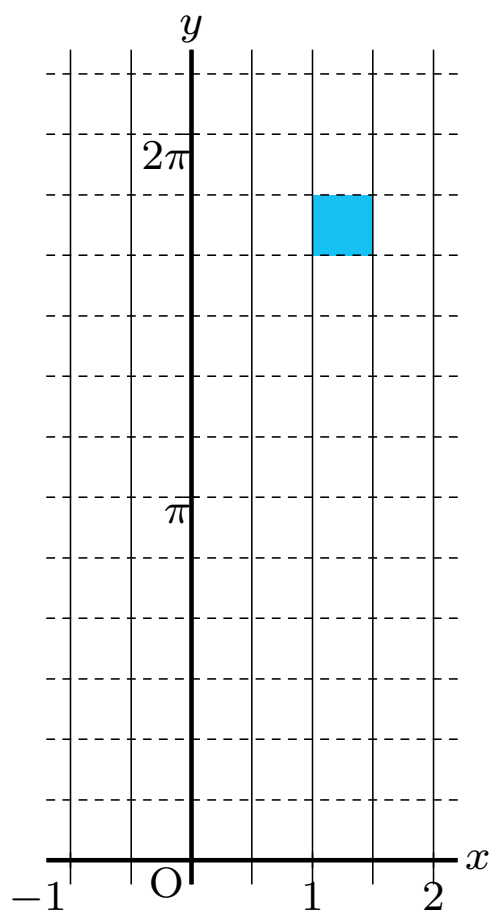

$w = e^z$ z -plane \longrightarrow w -plane

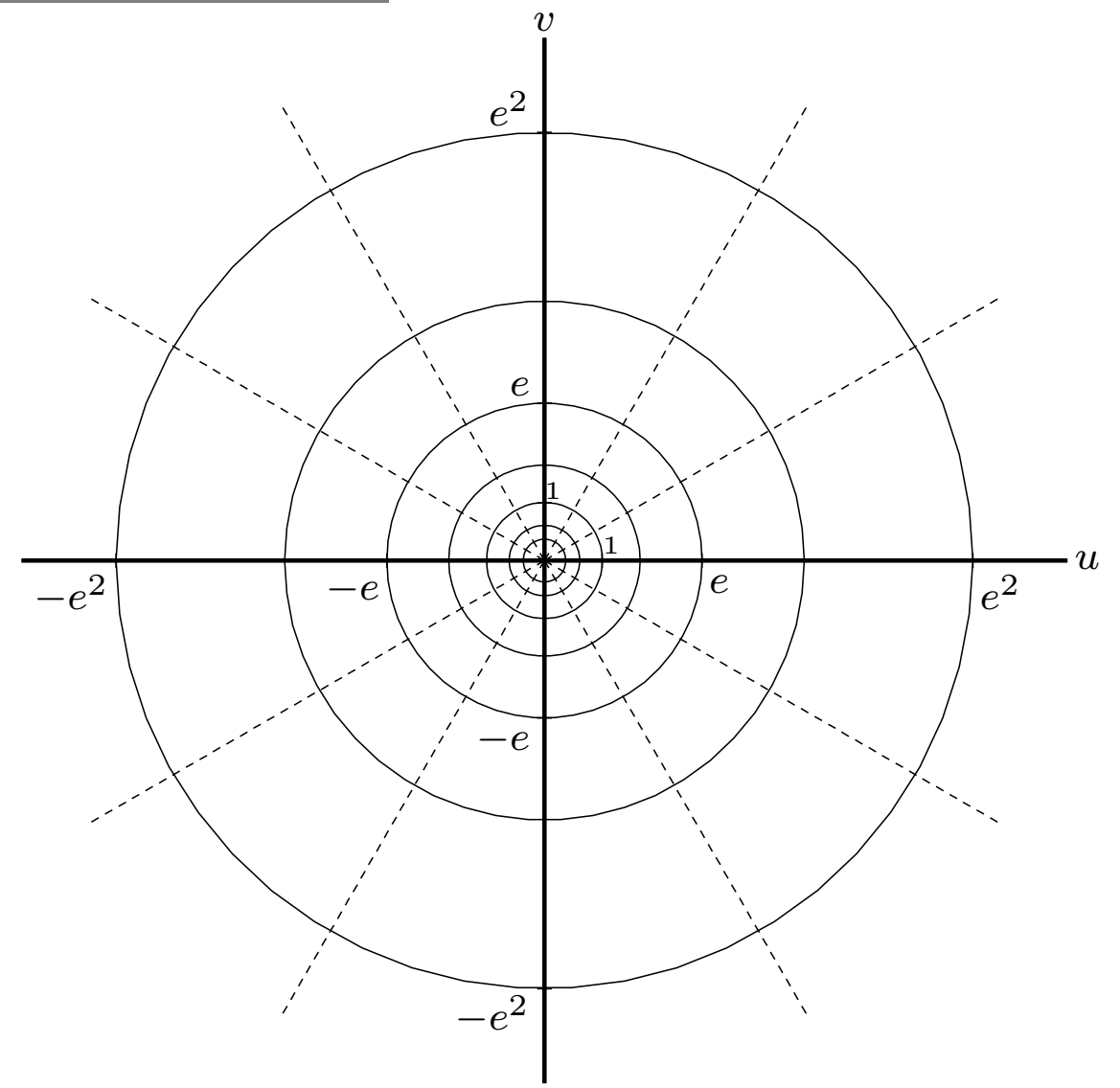
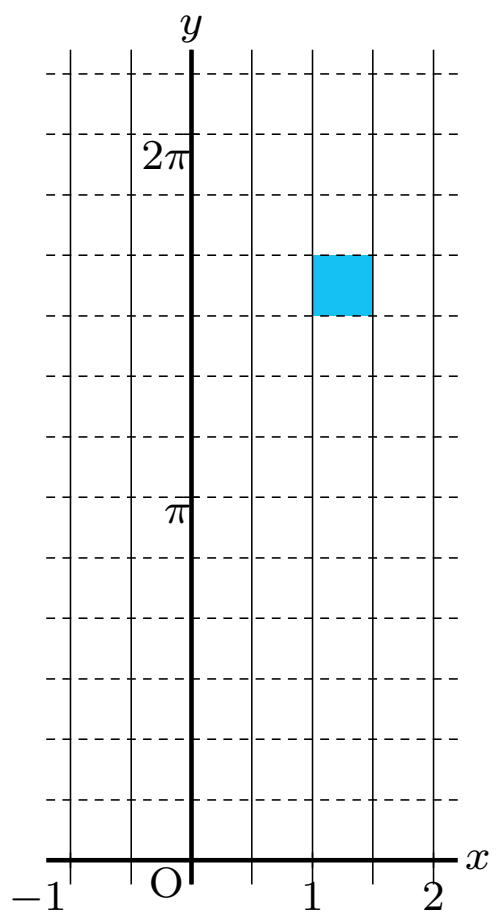

$w = e^z$ z -plane \longrightarrow w -plane

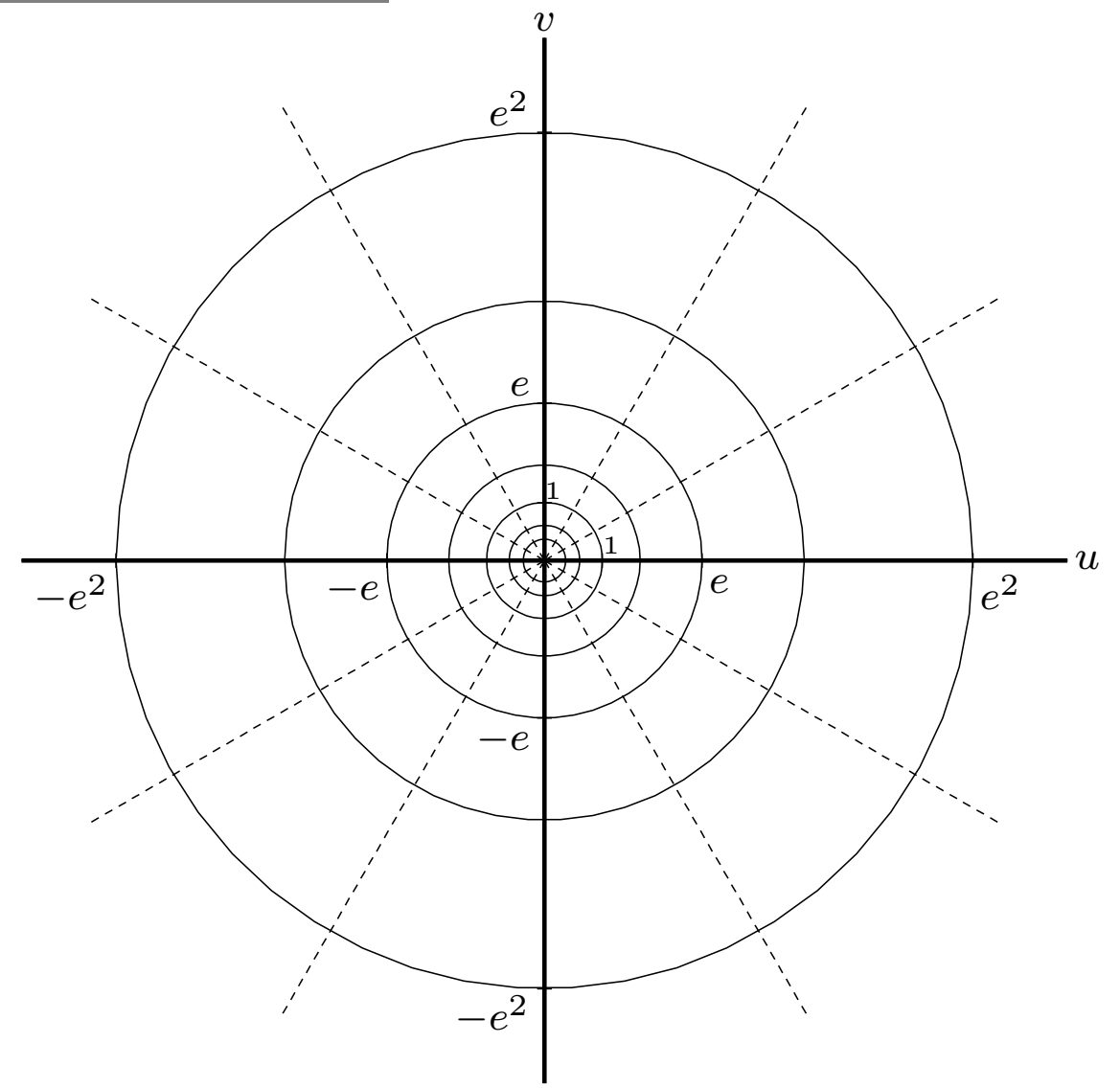
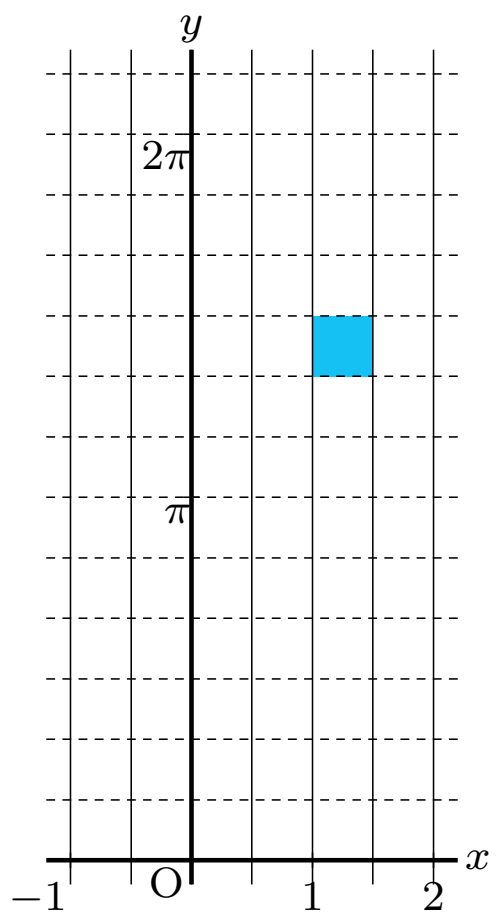

$w = e^z$ z -plane \longrightarrow w -plane

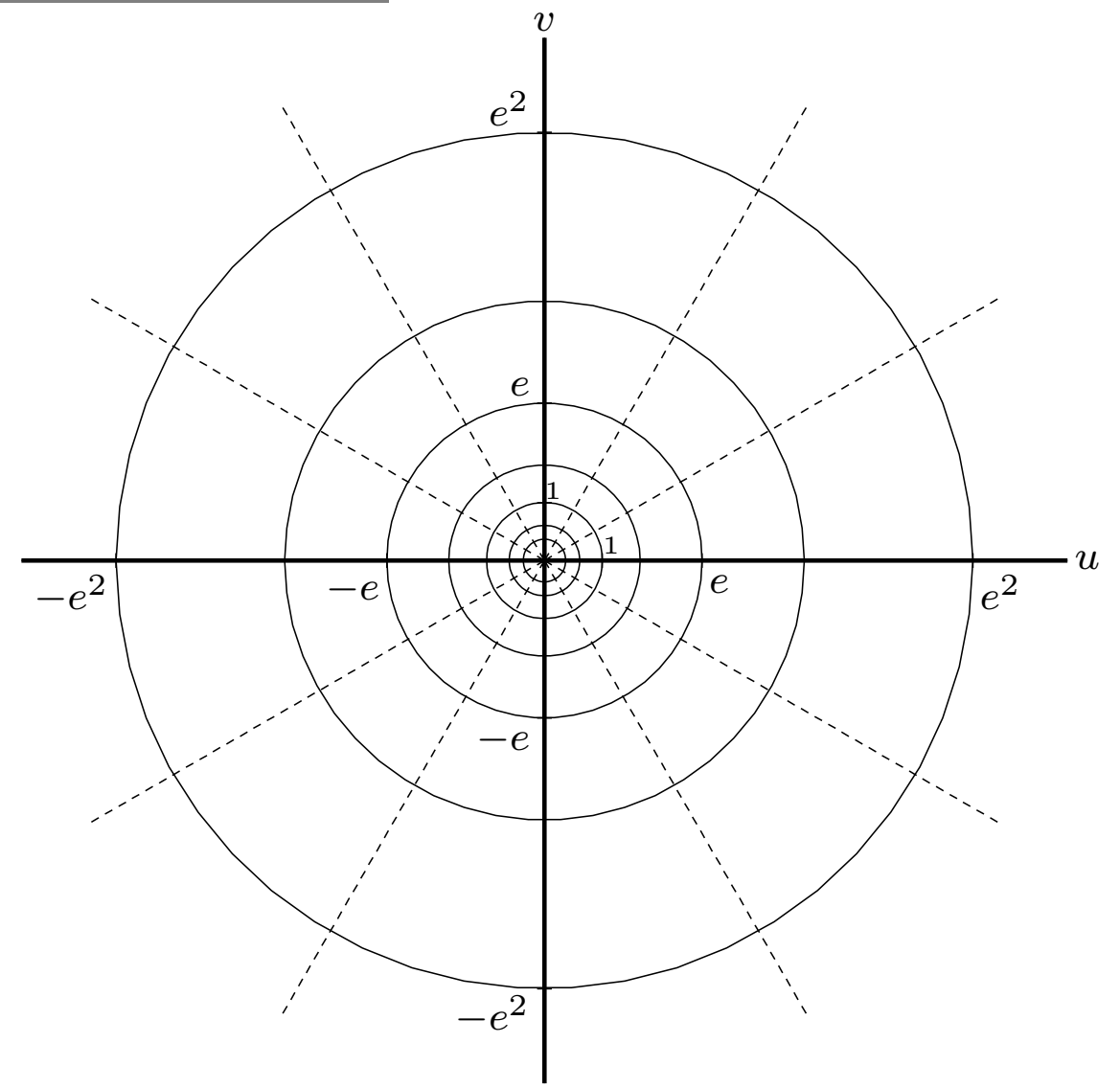
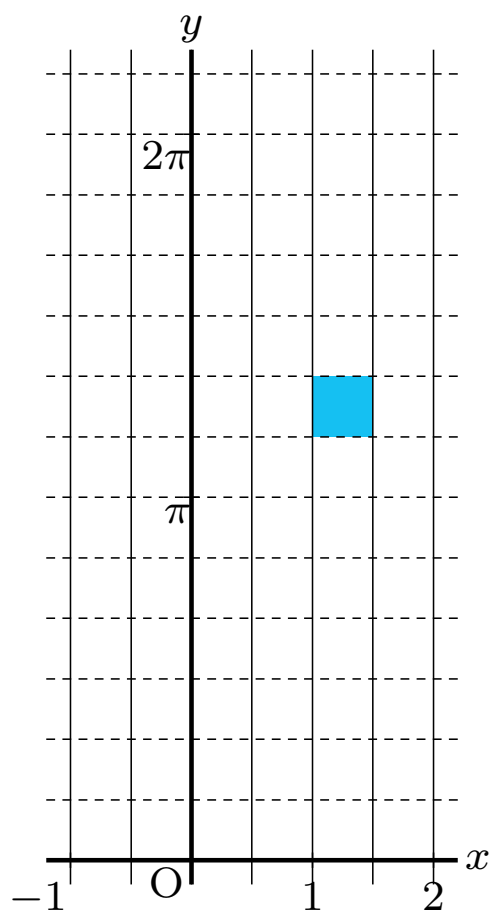

$w = e^z$ z -plane \longrightarrow w -plane

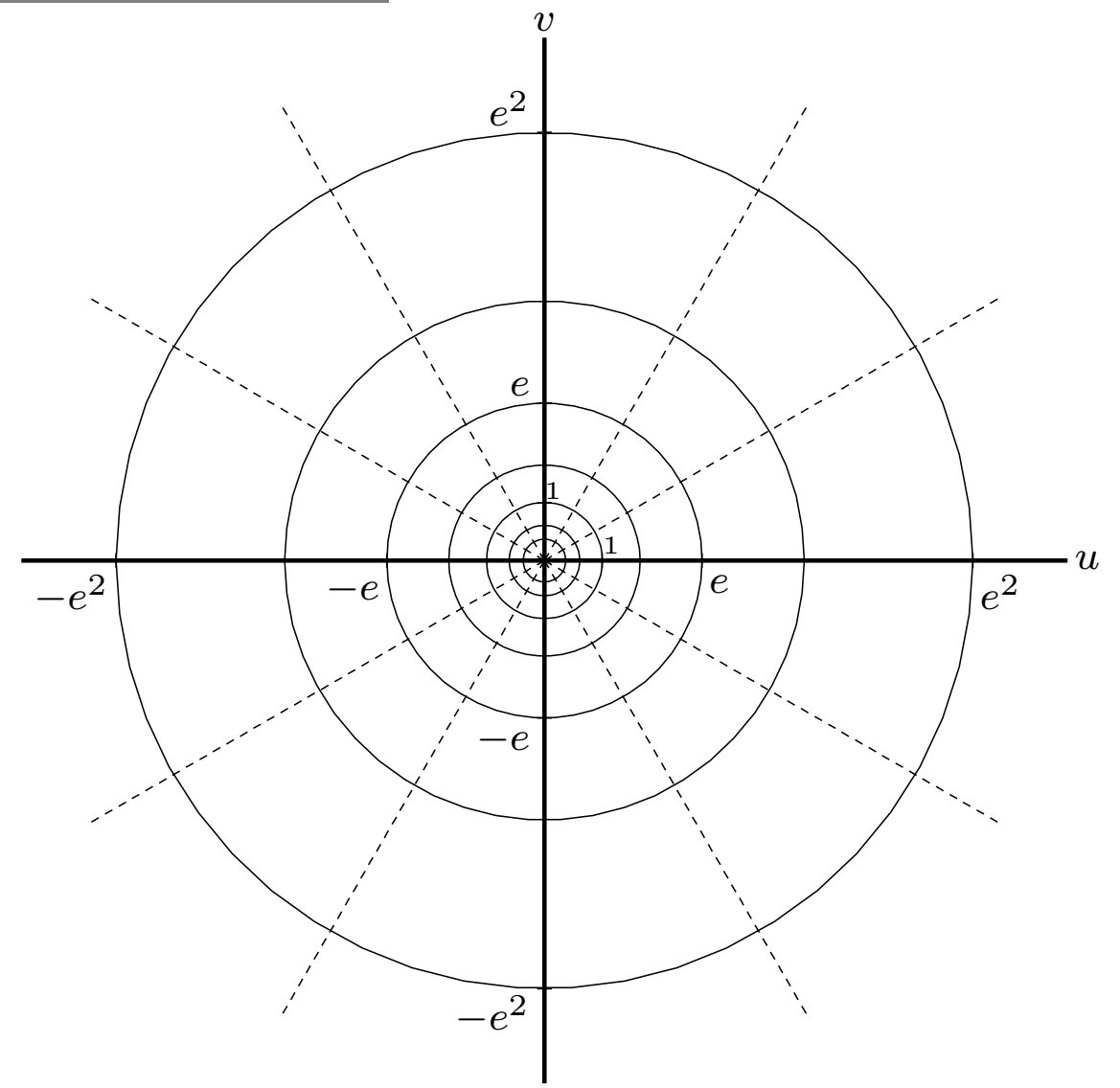
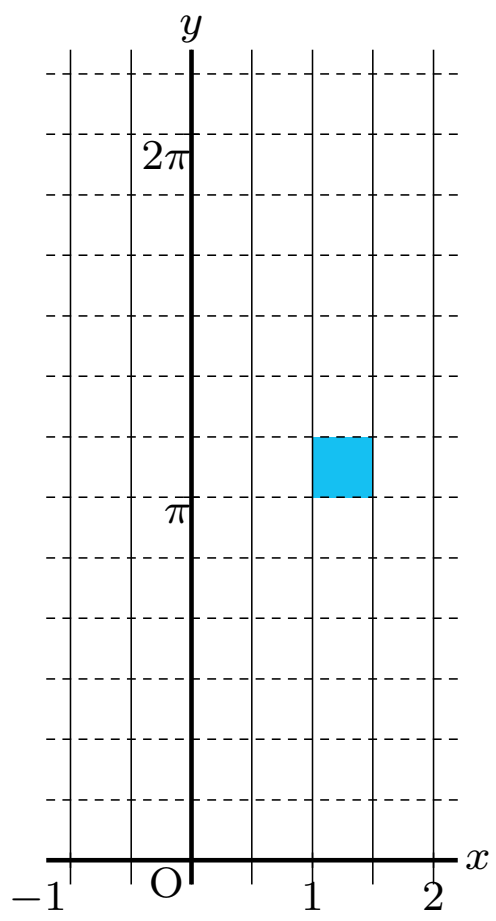

$w = e^z$ z -plane \longrightarrow w -plane

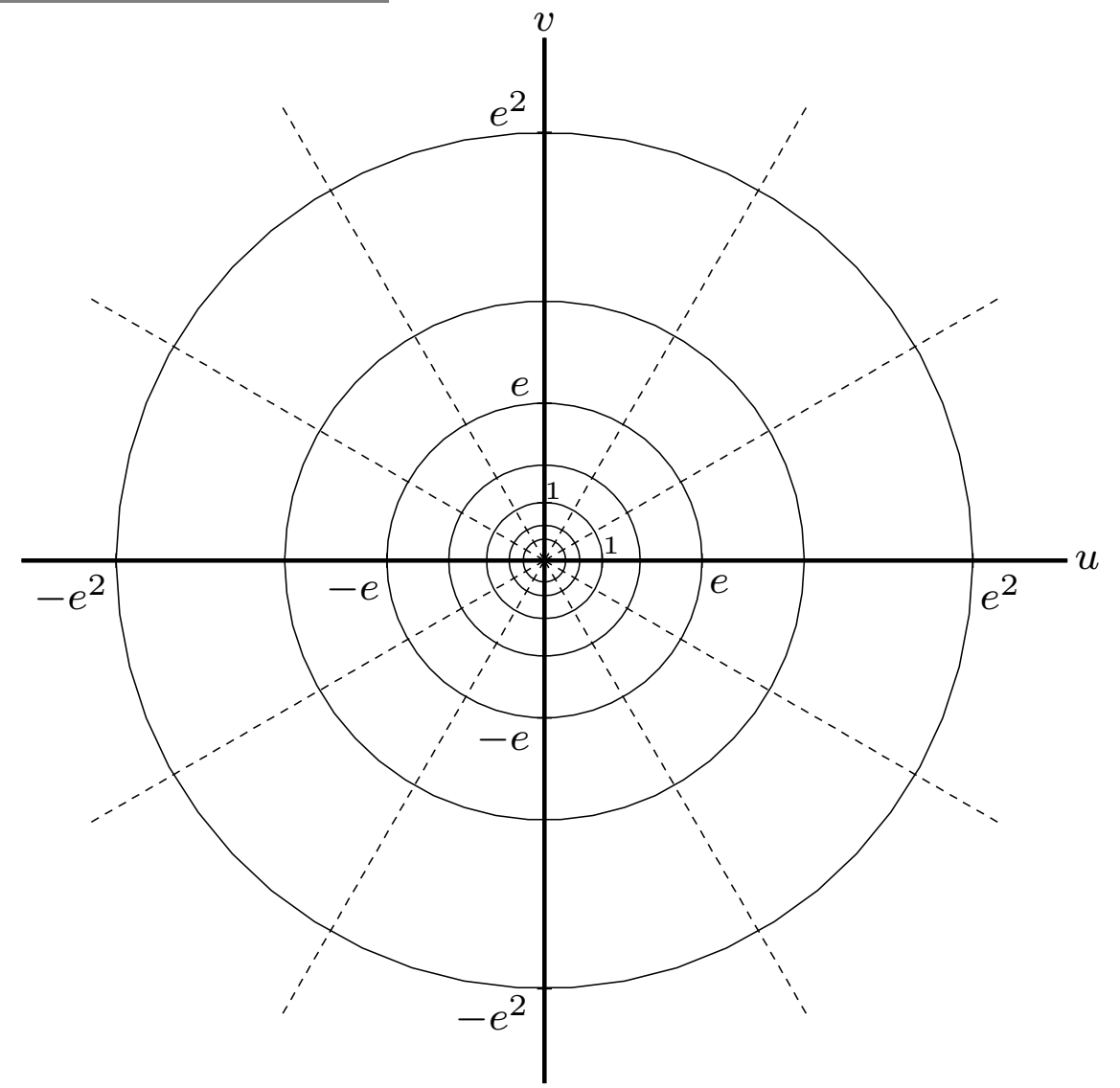
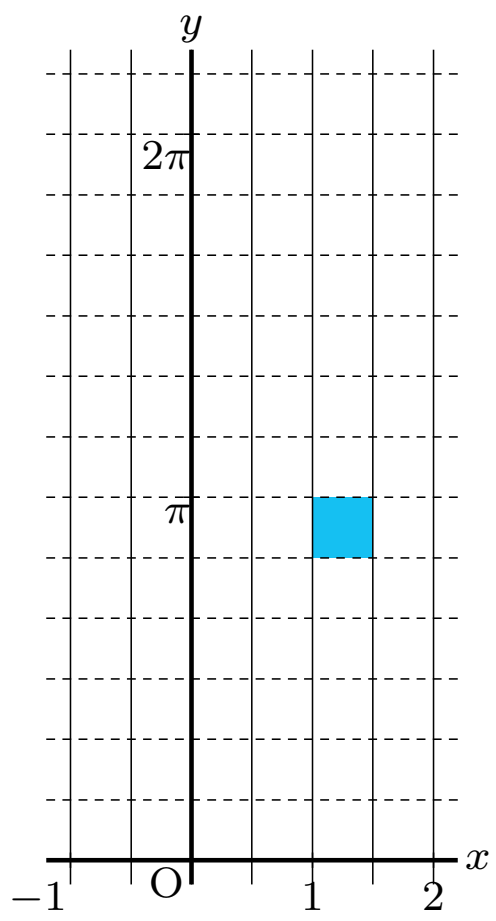

$w = e^z$ z -plane \longrightarrow w -plane

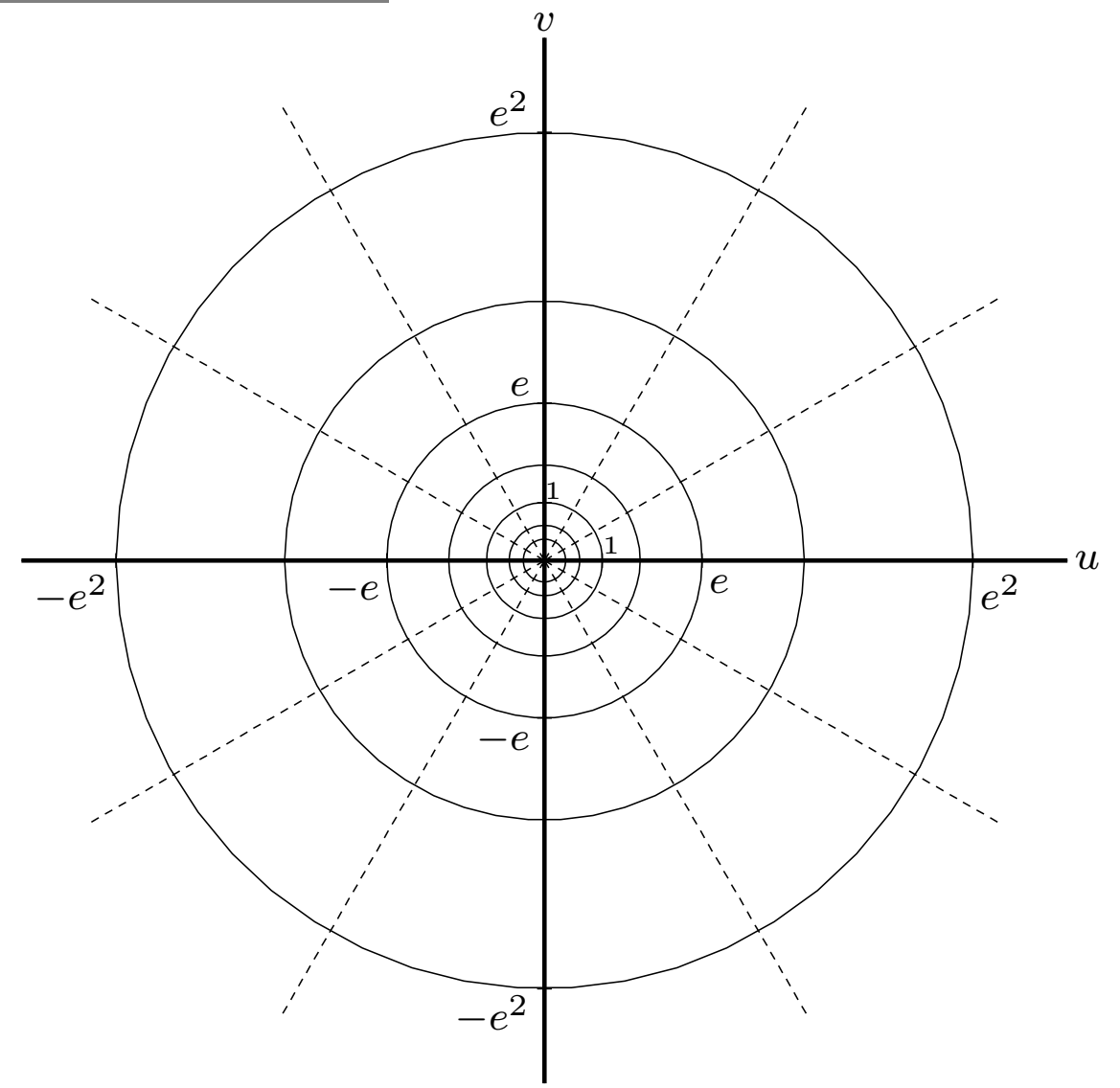
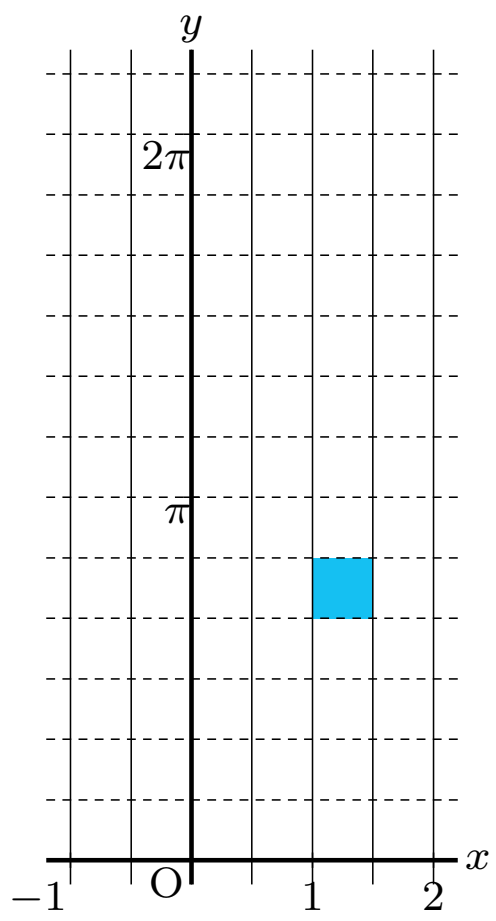

$w = e^z$ z -plane \longrightarrow w -plane

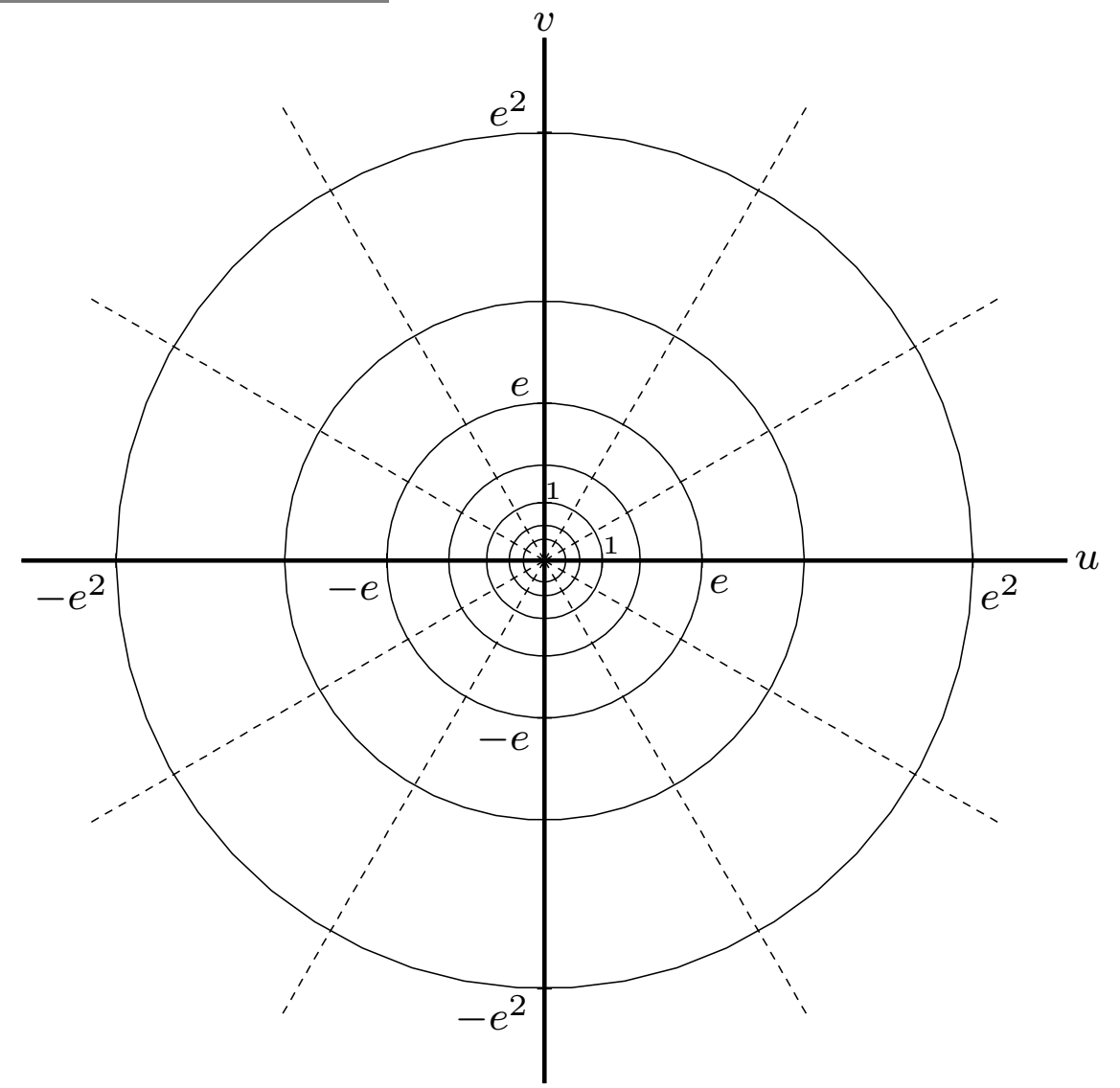
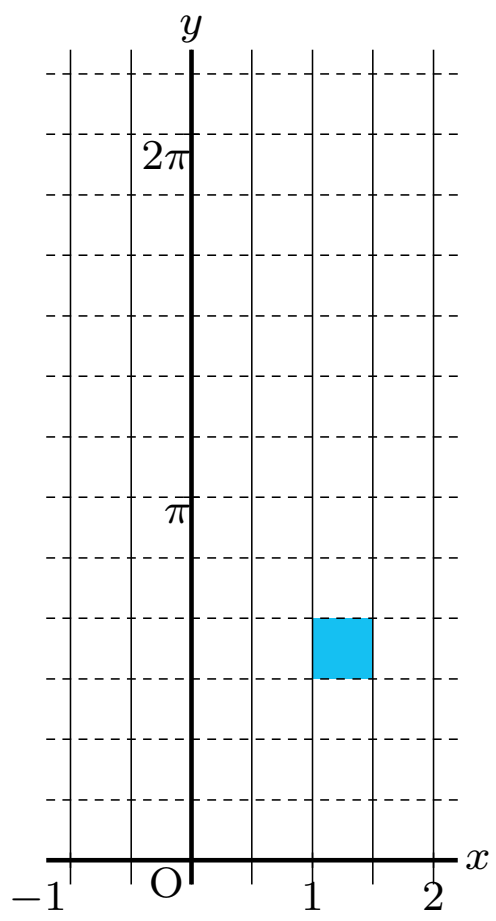

$w = e^z$ z -plane \longrightarrow w -plane

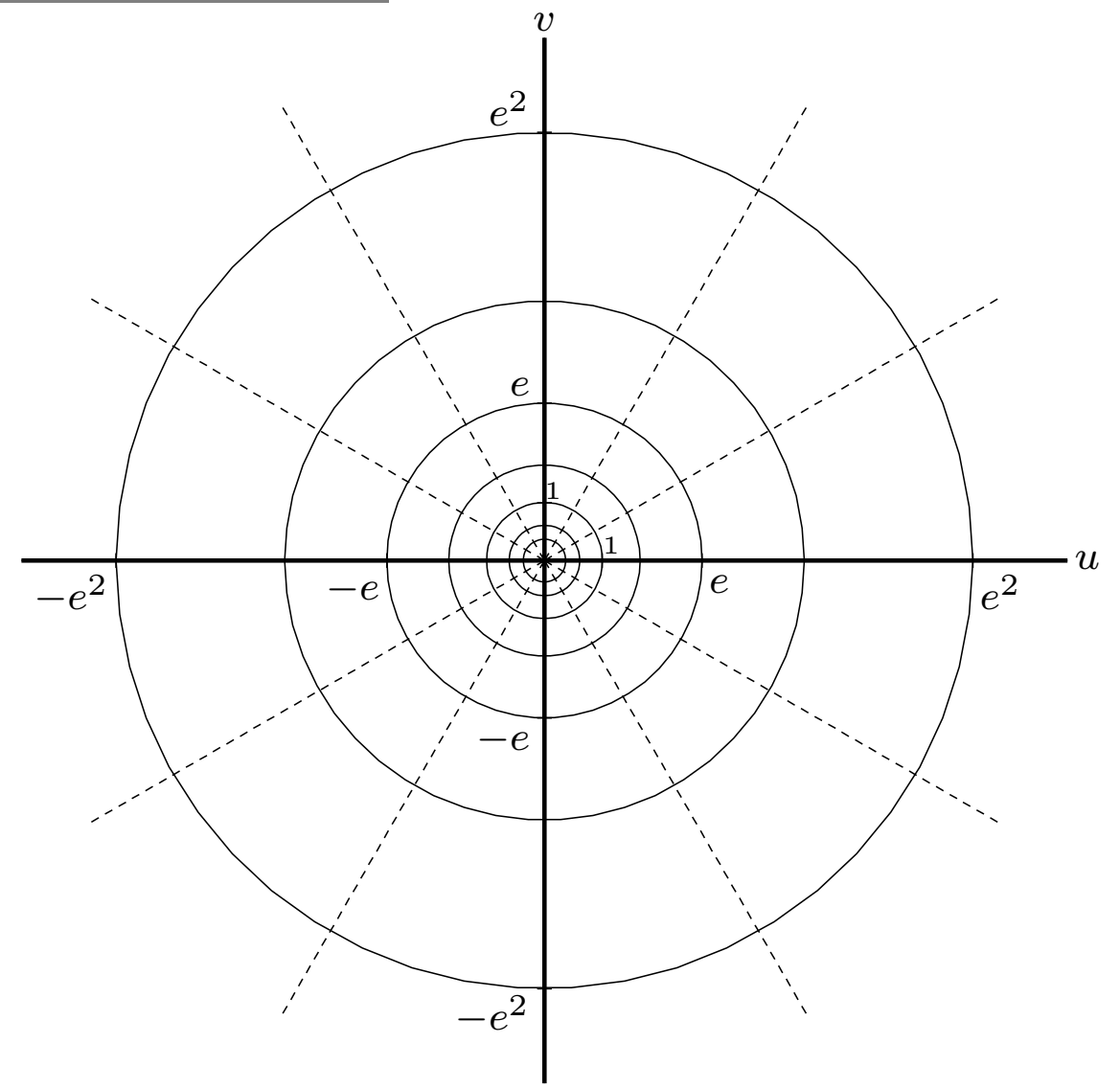
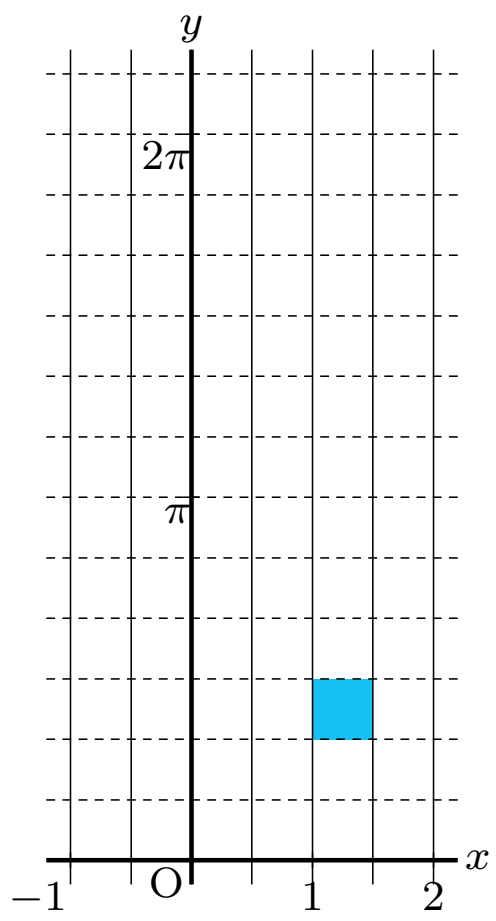

$w = e^z$ z -plane \longrightarrow w -plane

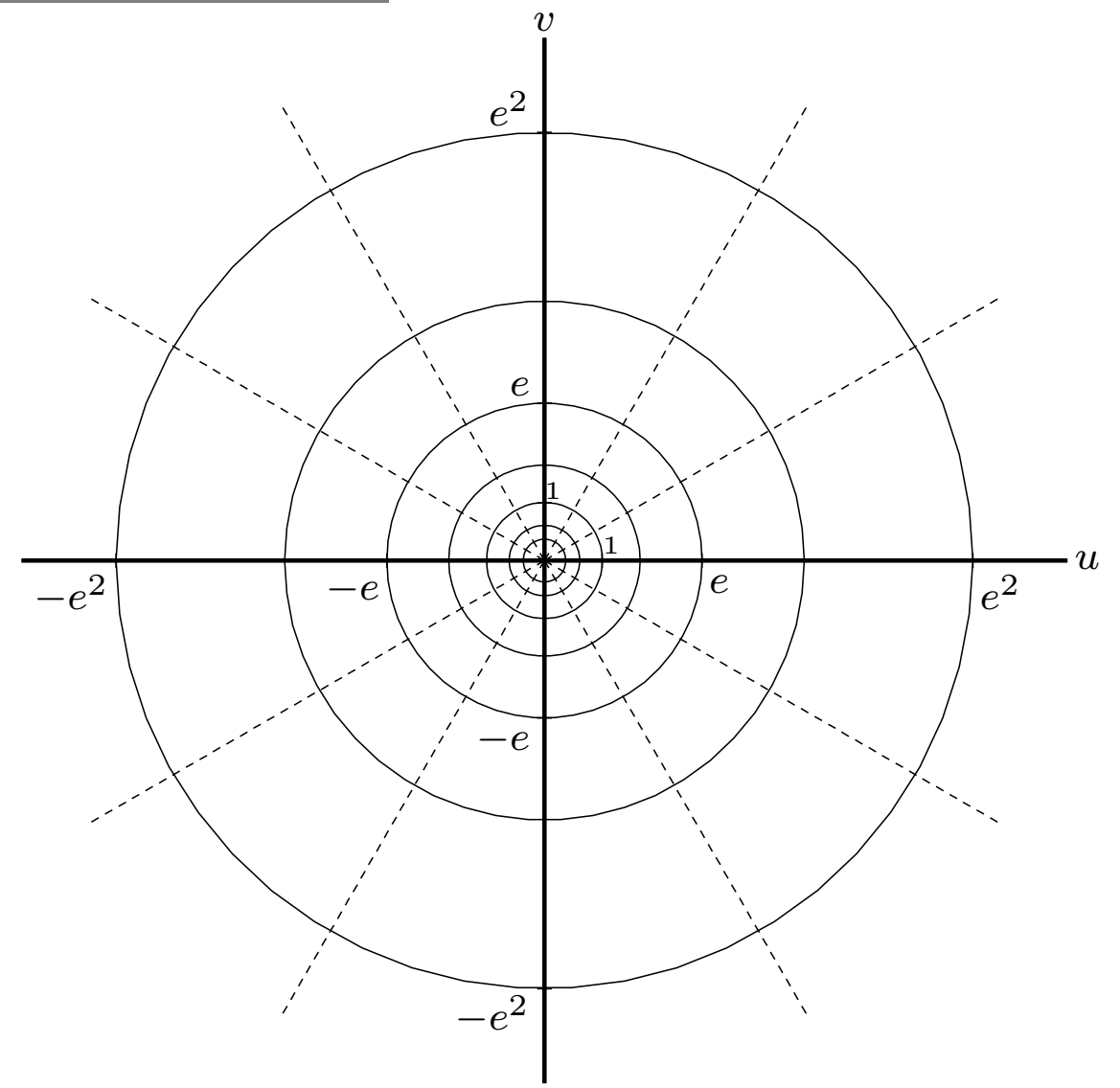
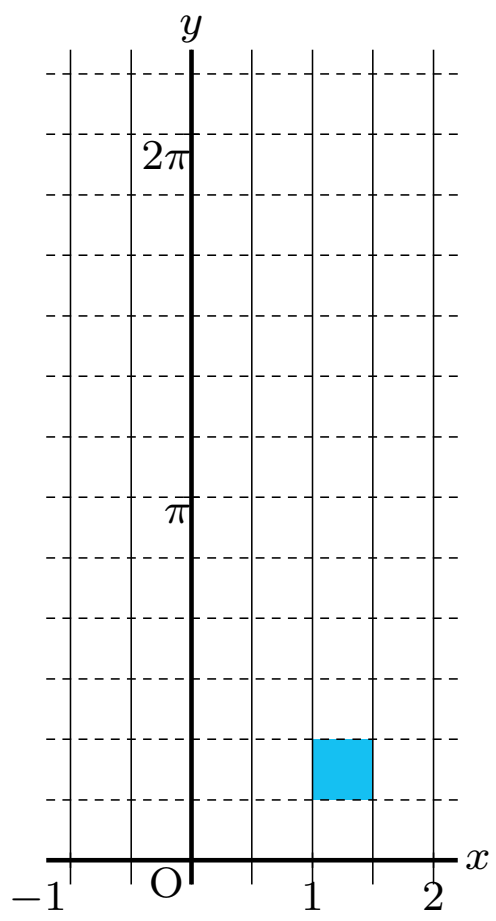

$w = e^z$ z -plane \longrightarrow w -plane

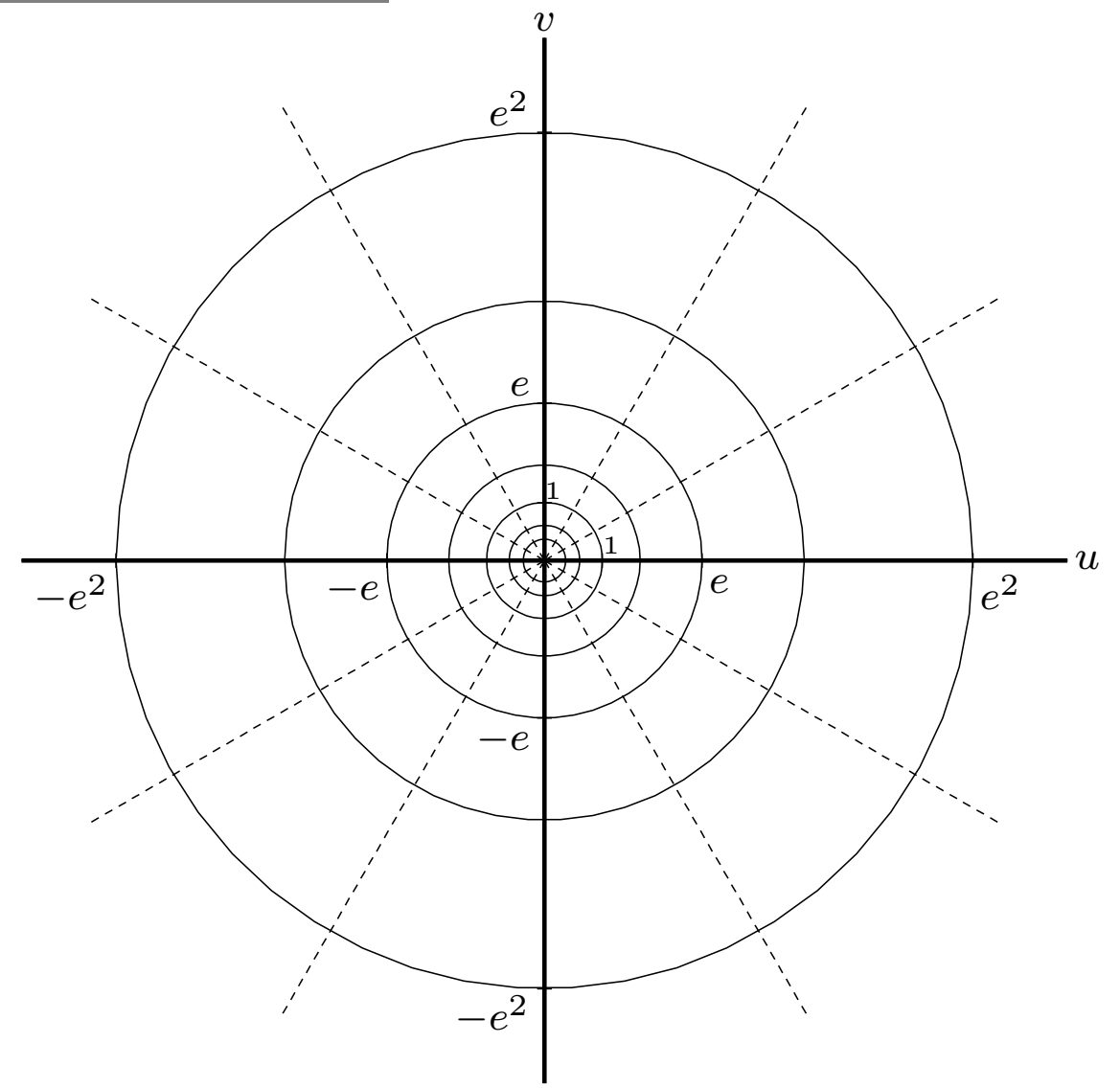
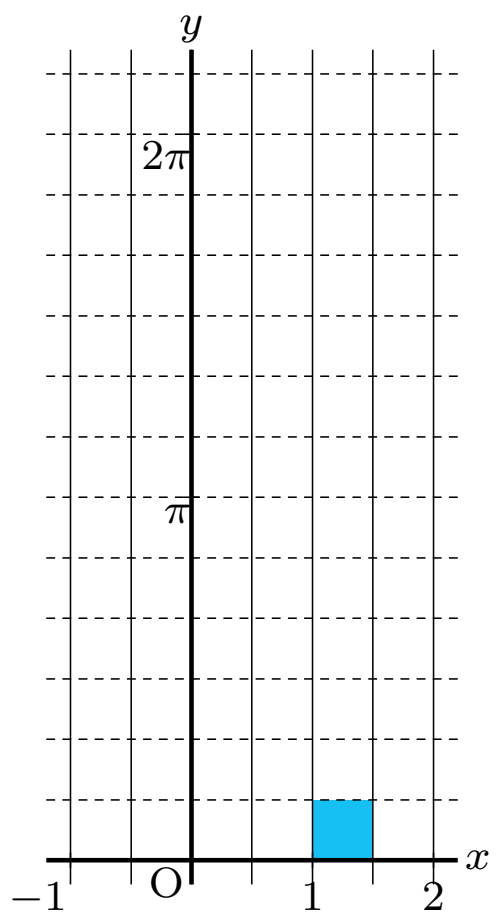

$w = e^z$ z -plane \longrightarrow w -plane

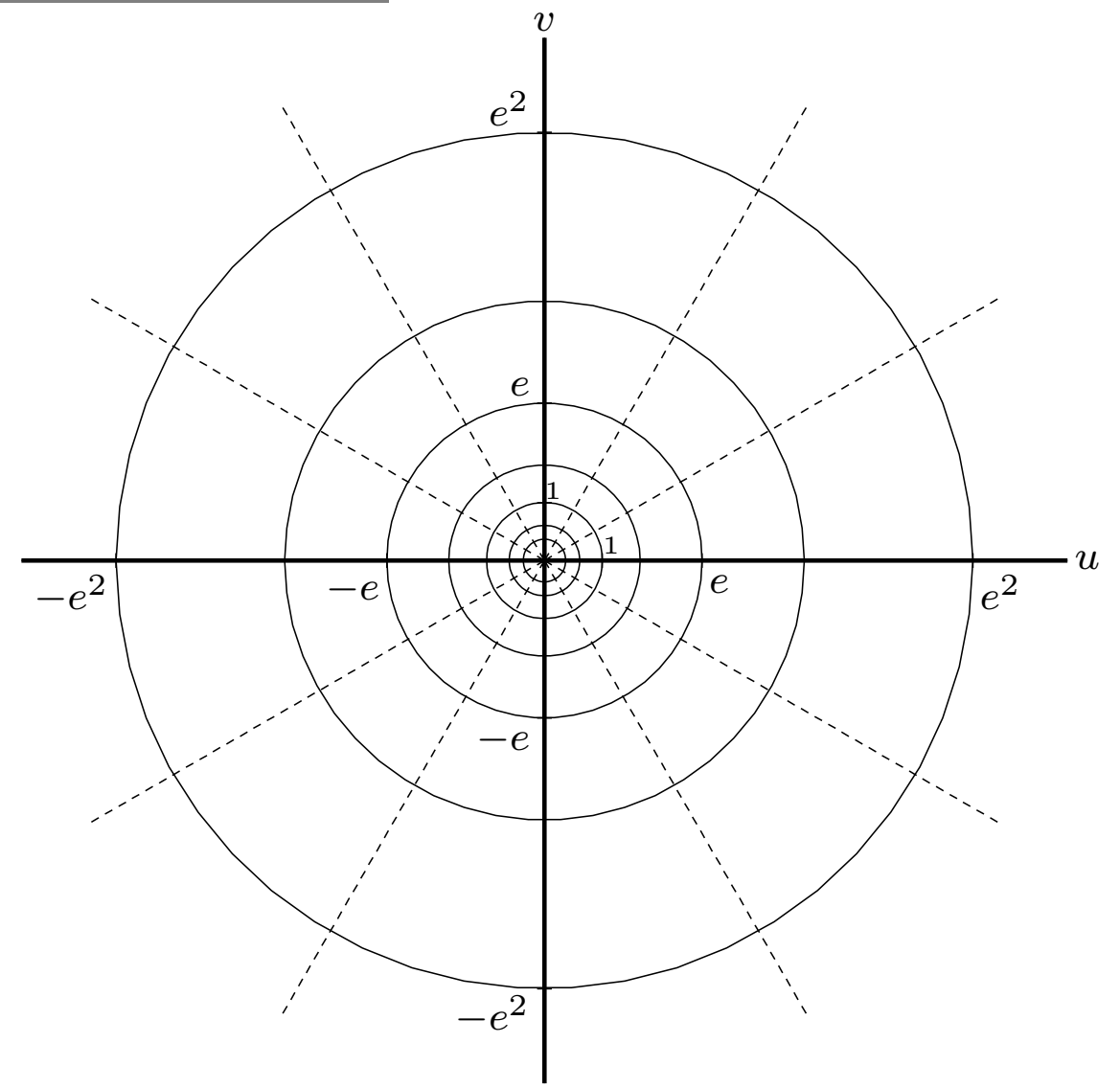
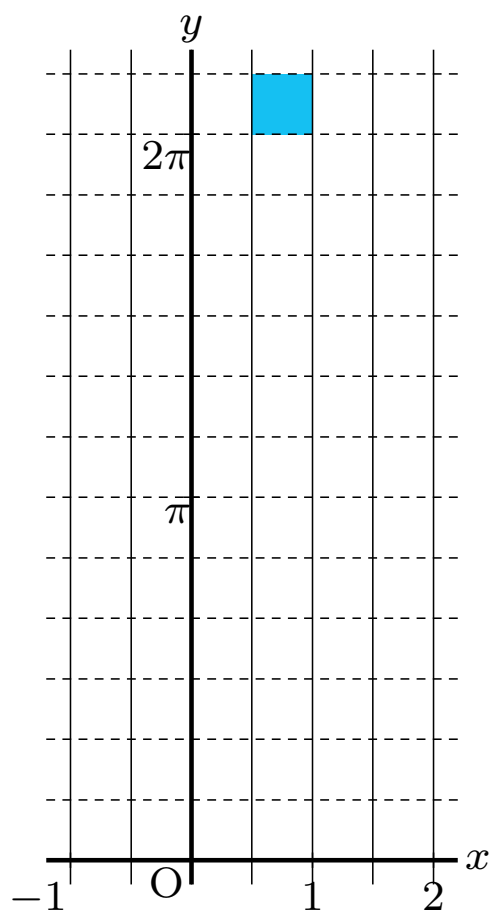

$w = e^z$ z -plane \longrightarrow w -plane

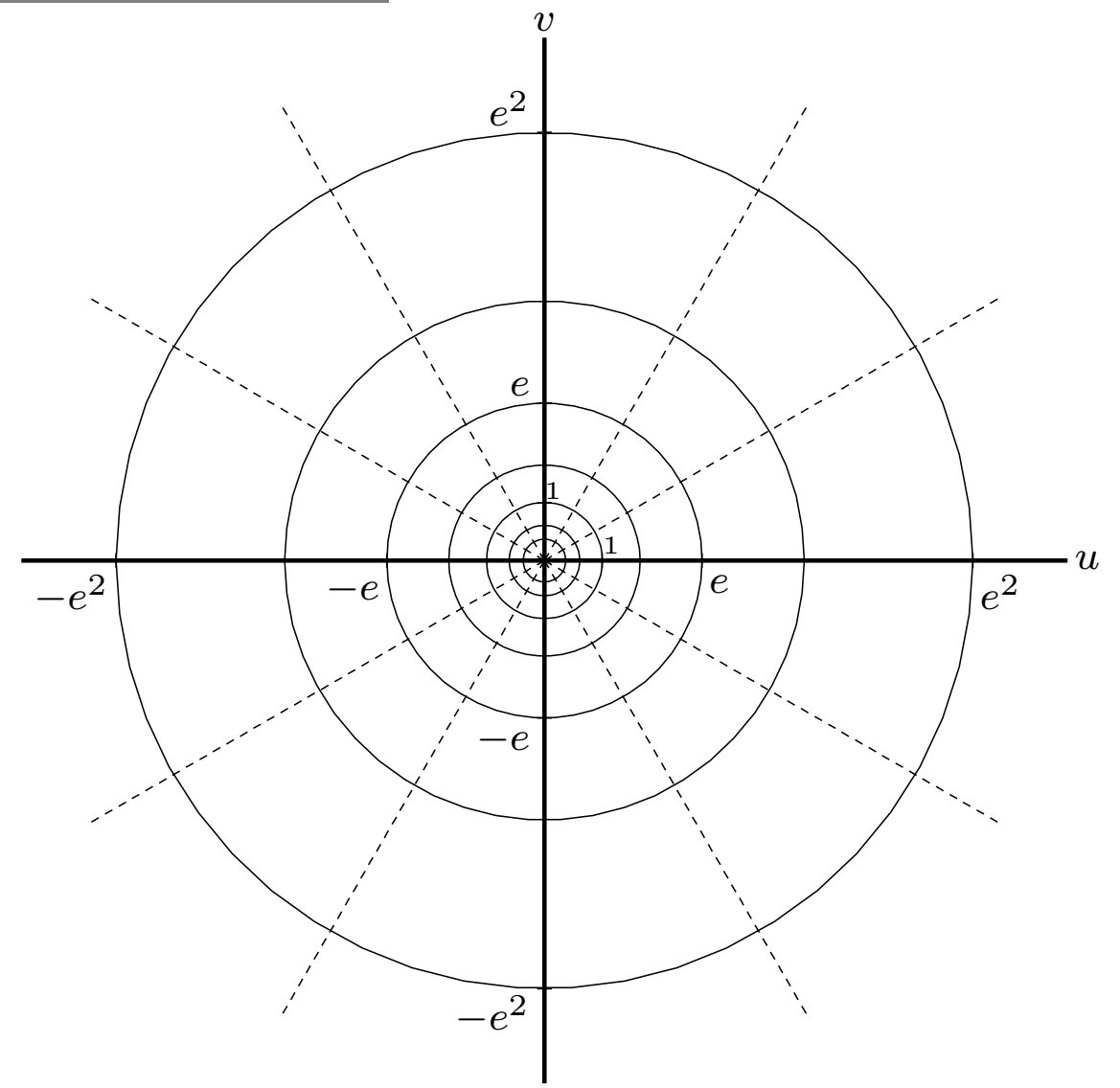
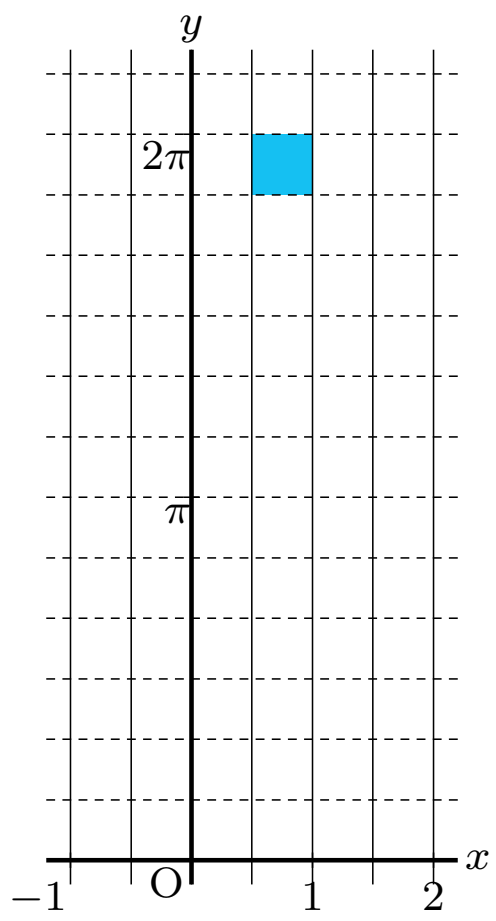

$w = e^z$ z -plane \longrightarrow w -plane

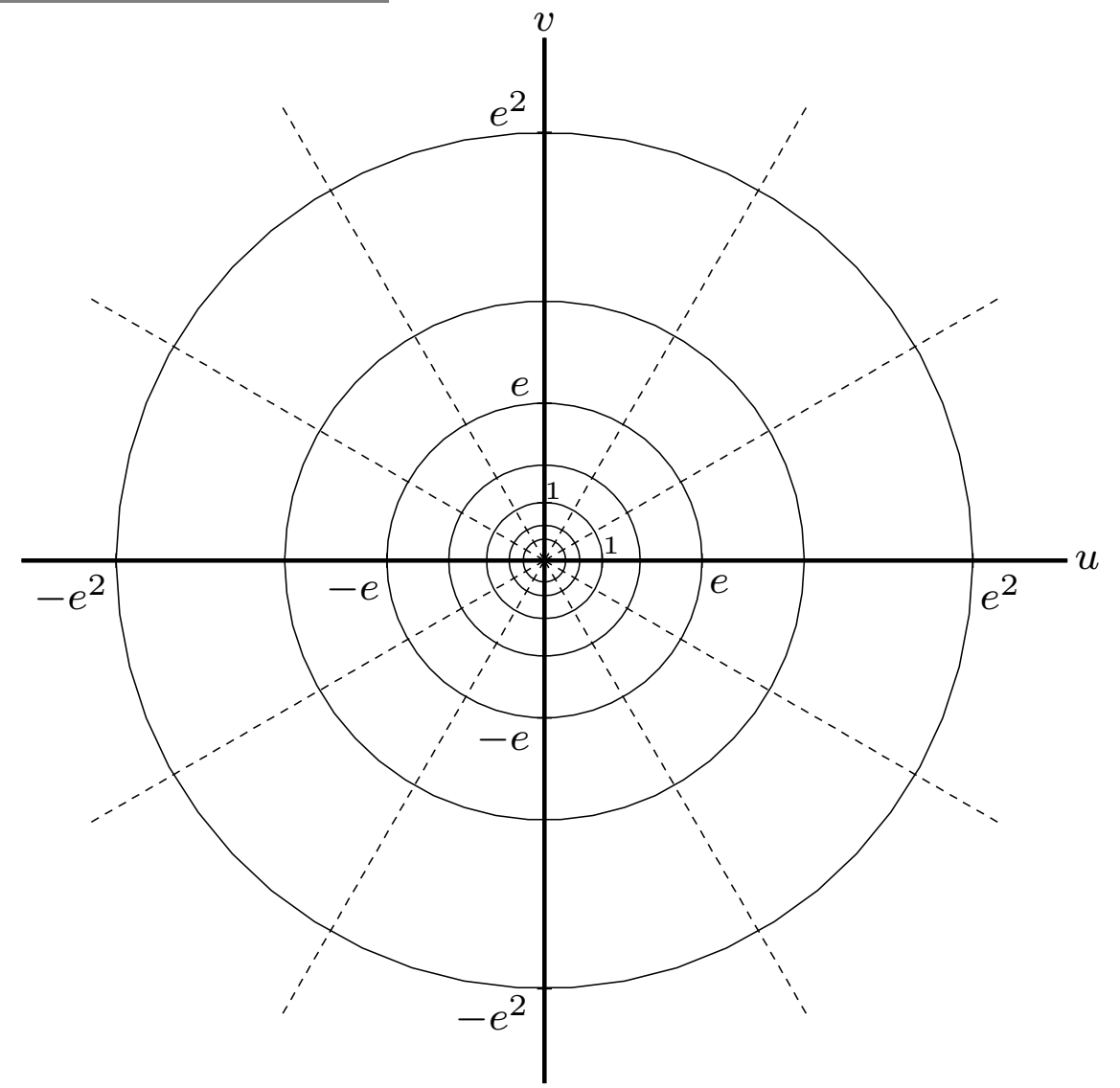
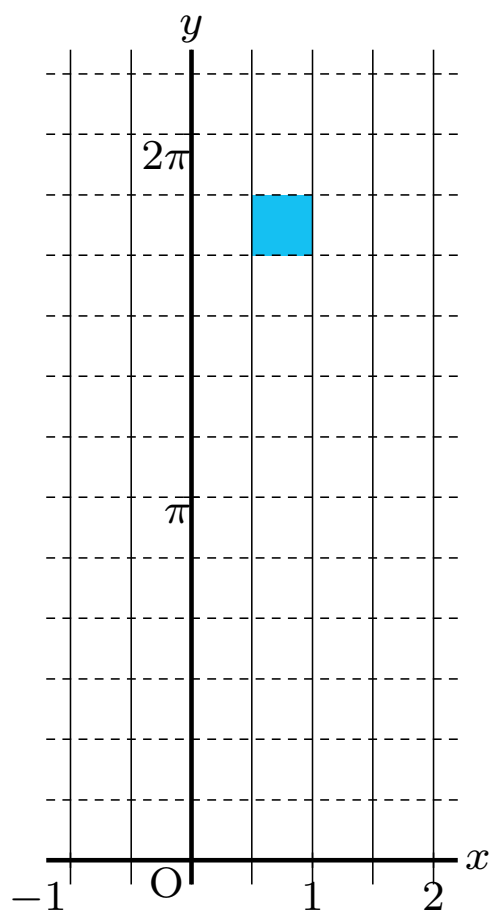

$w = e^z$ z -plane \longrightarrow w -plane

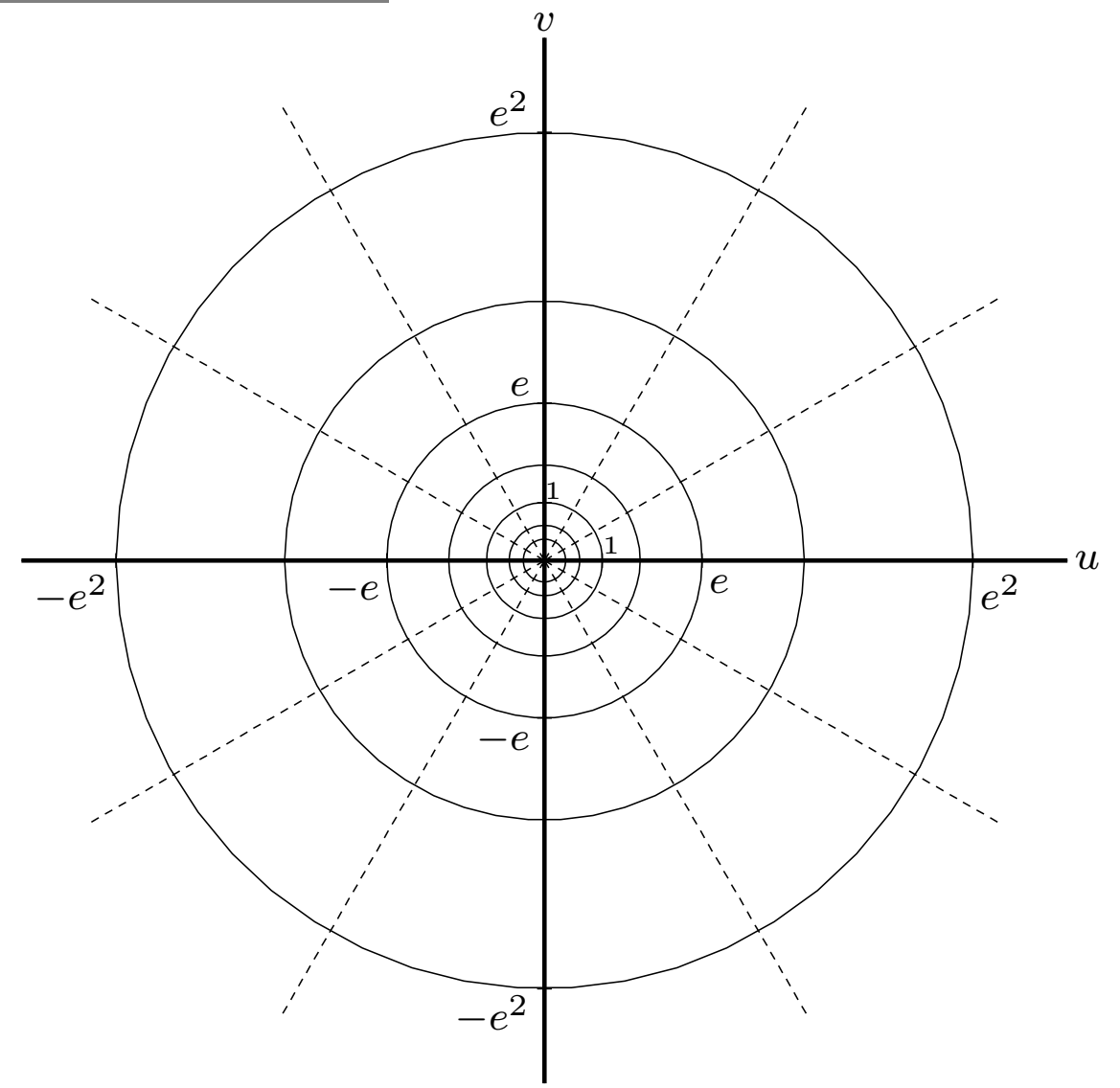
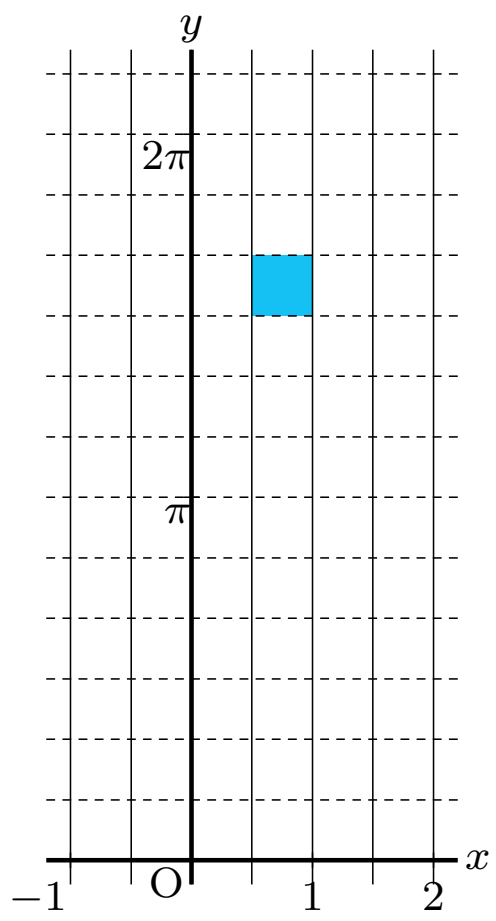

$w = e^z$ z -plane \longrightarrow w -plane

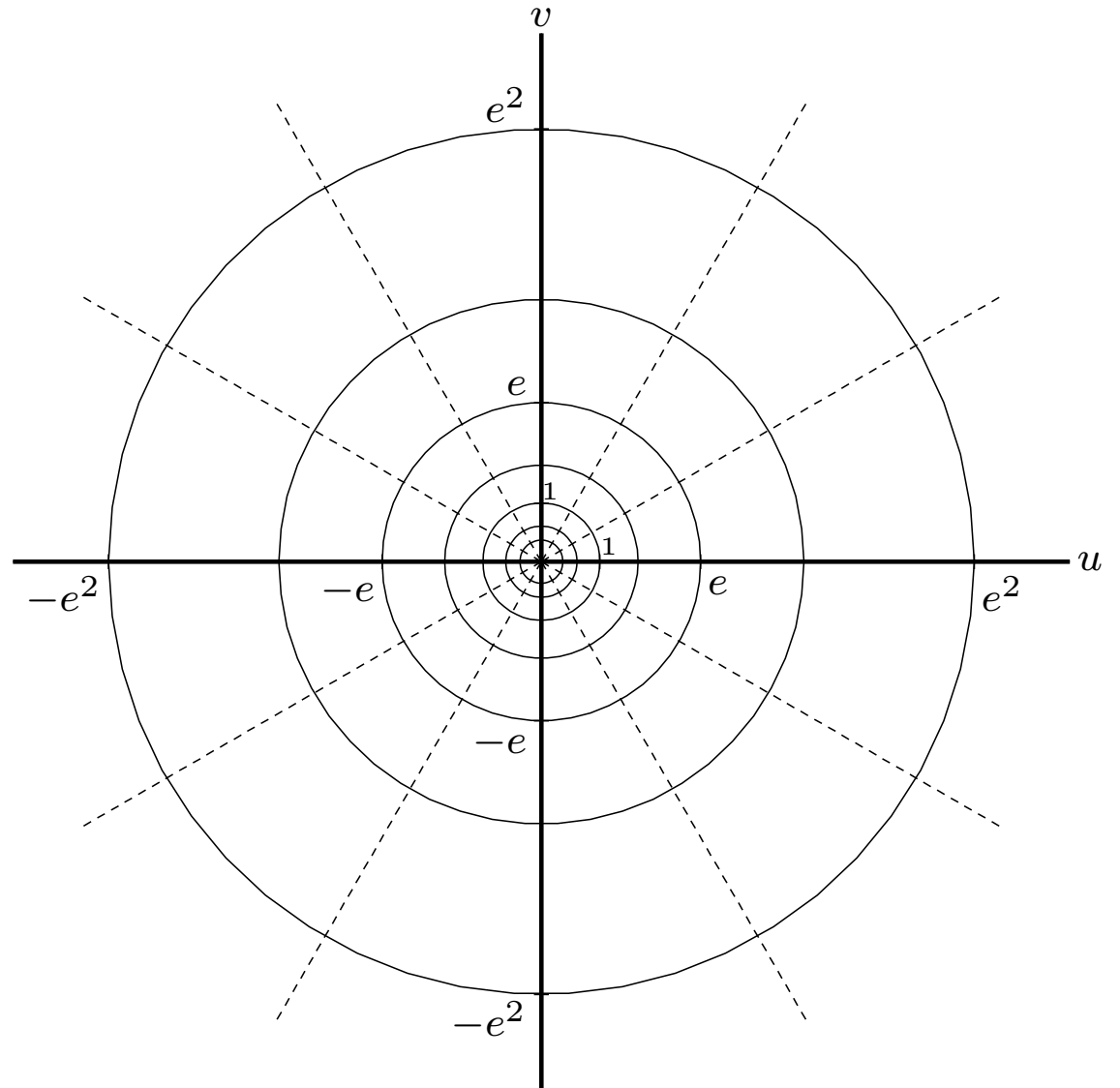
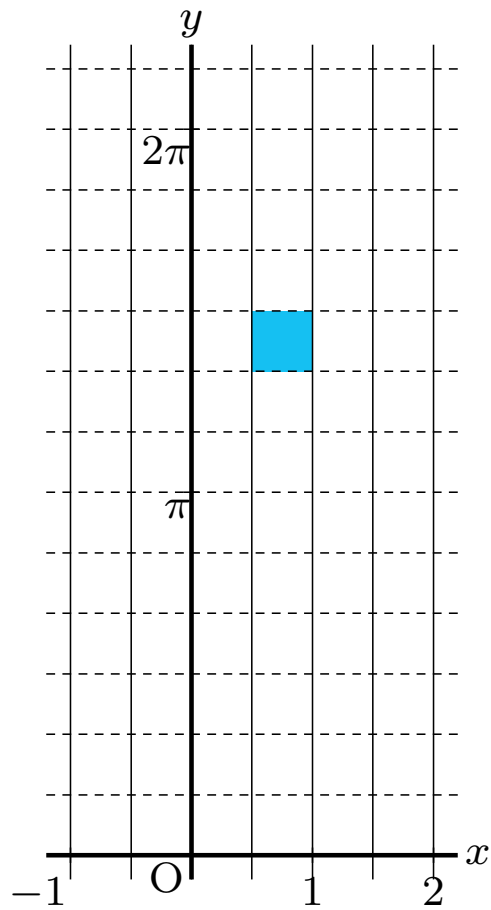

$w = e^z$ z -plane \longrightarrow w -plane

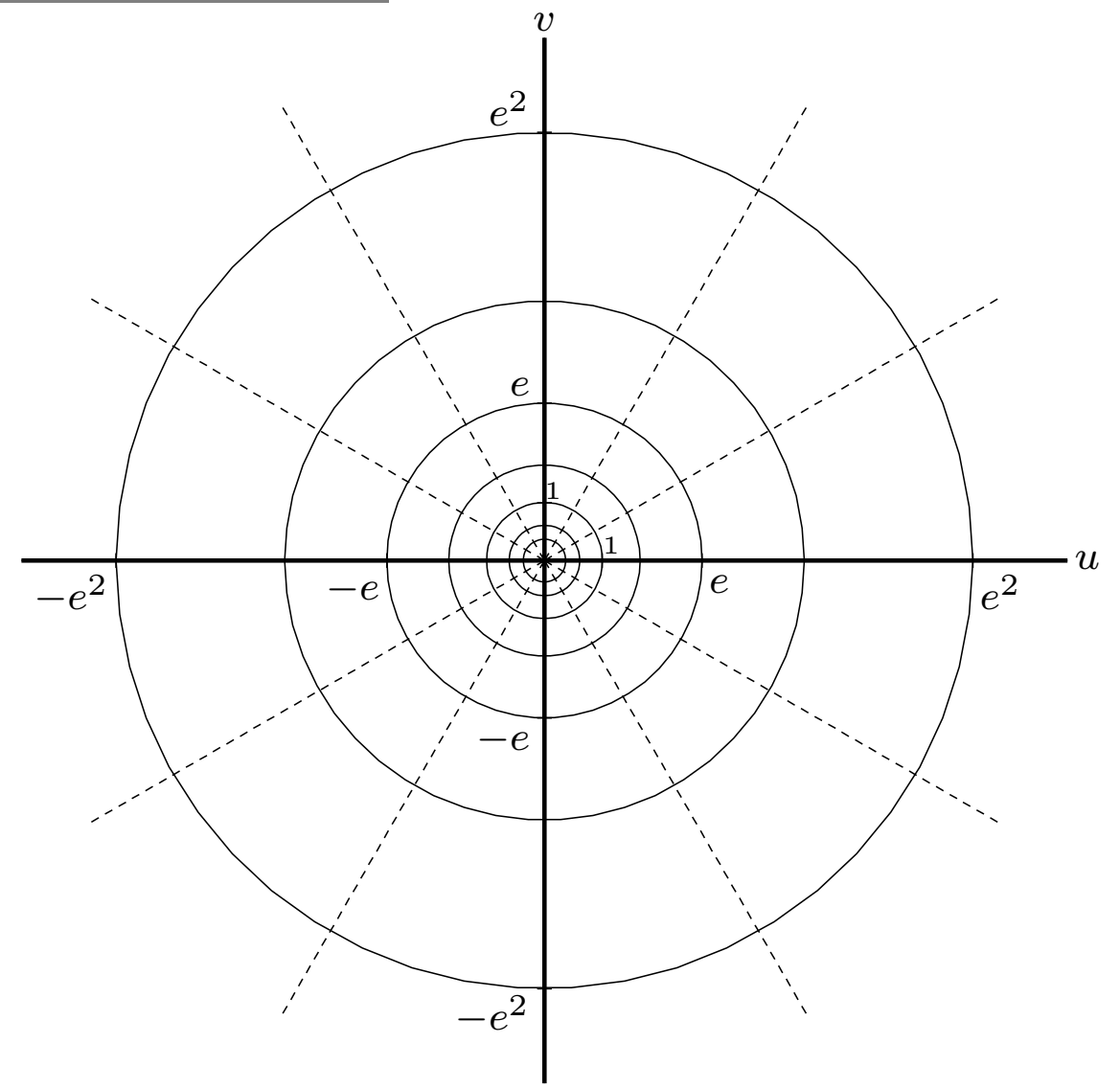
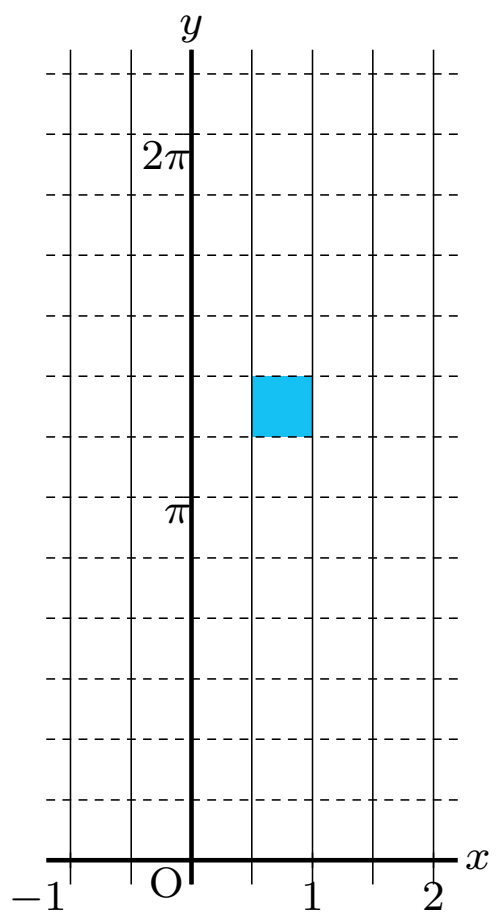

$w = e^z$ z -plane \longrightarrow w -plane

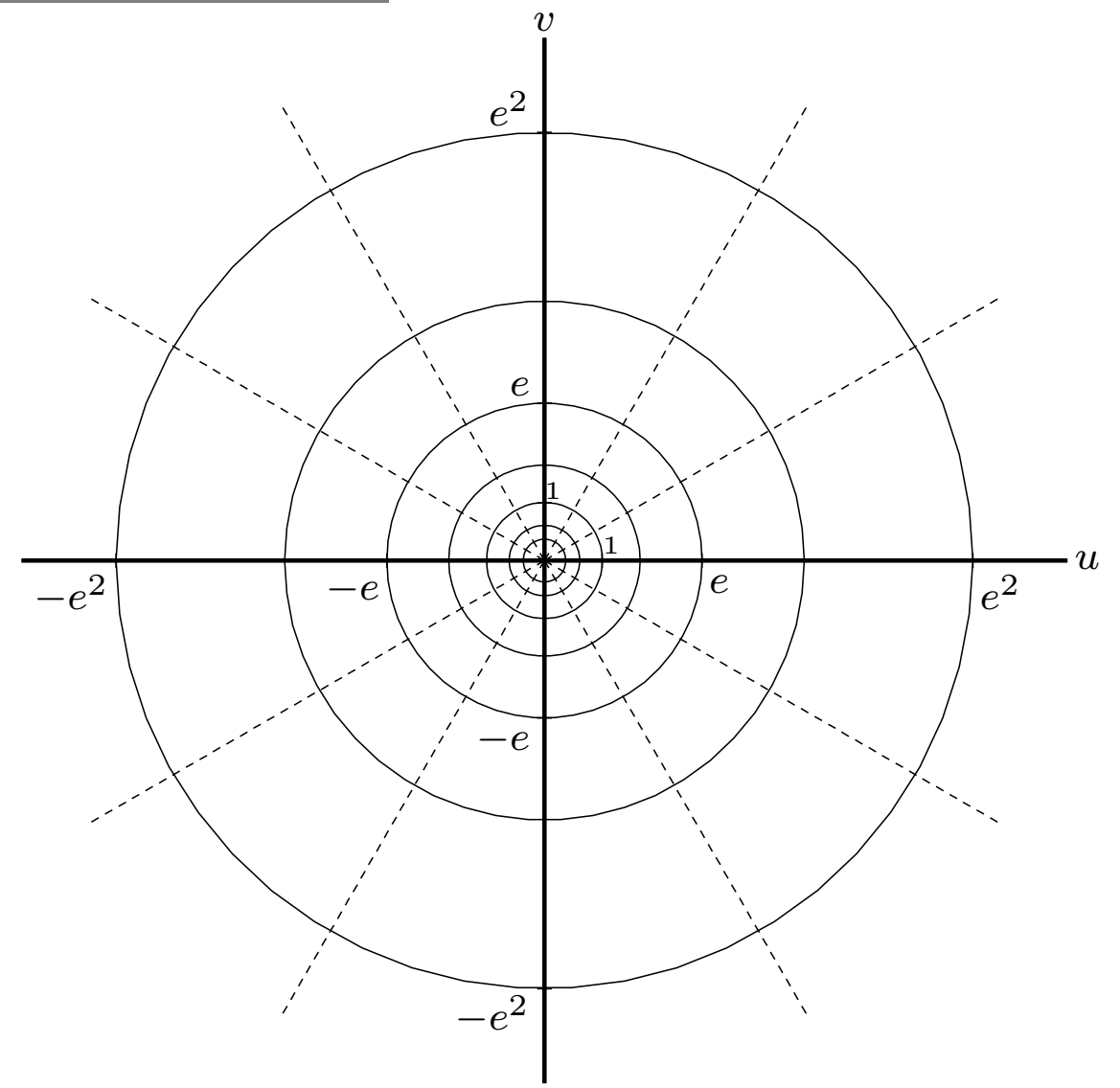
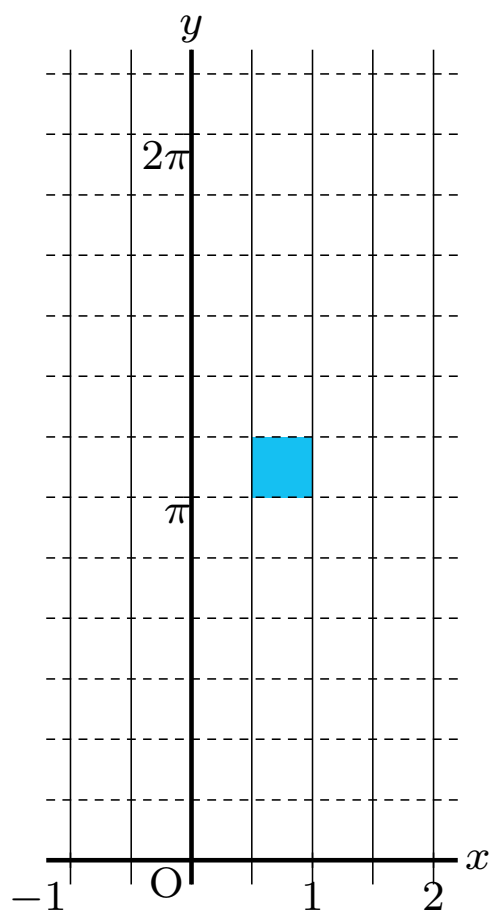

$w = e^z$ z -plane \longrightarrow w -plane

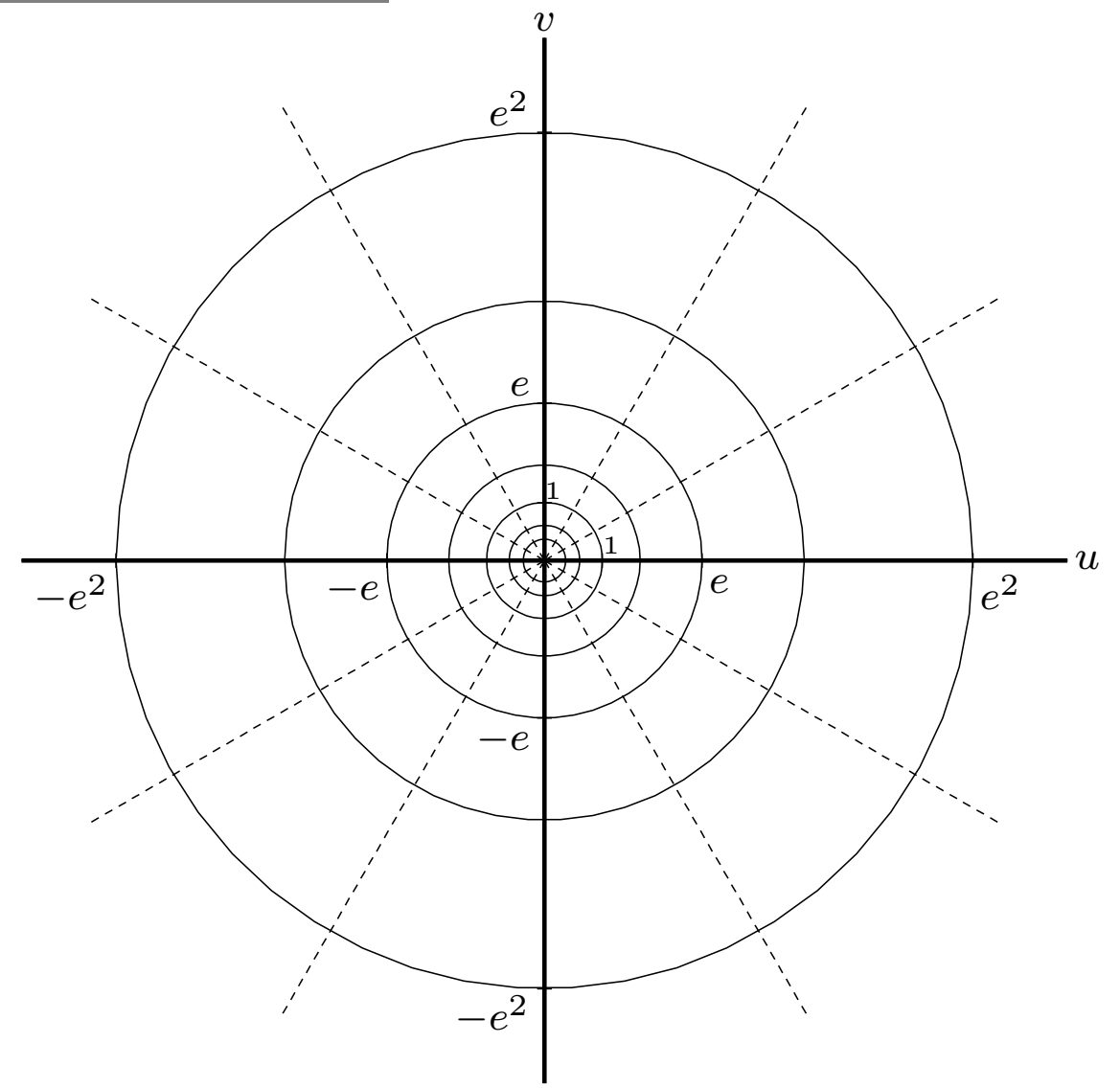
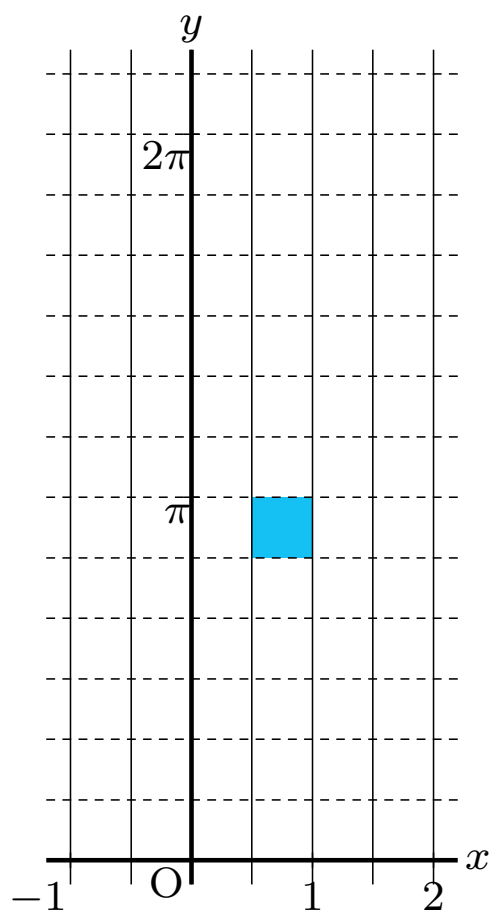

$w = e^z$ z -plane \longrightarrow w -plane

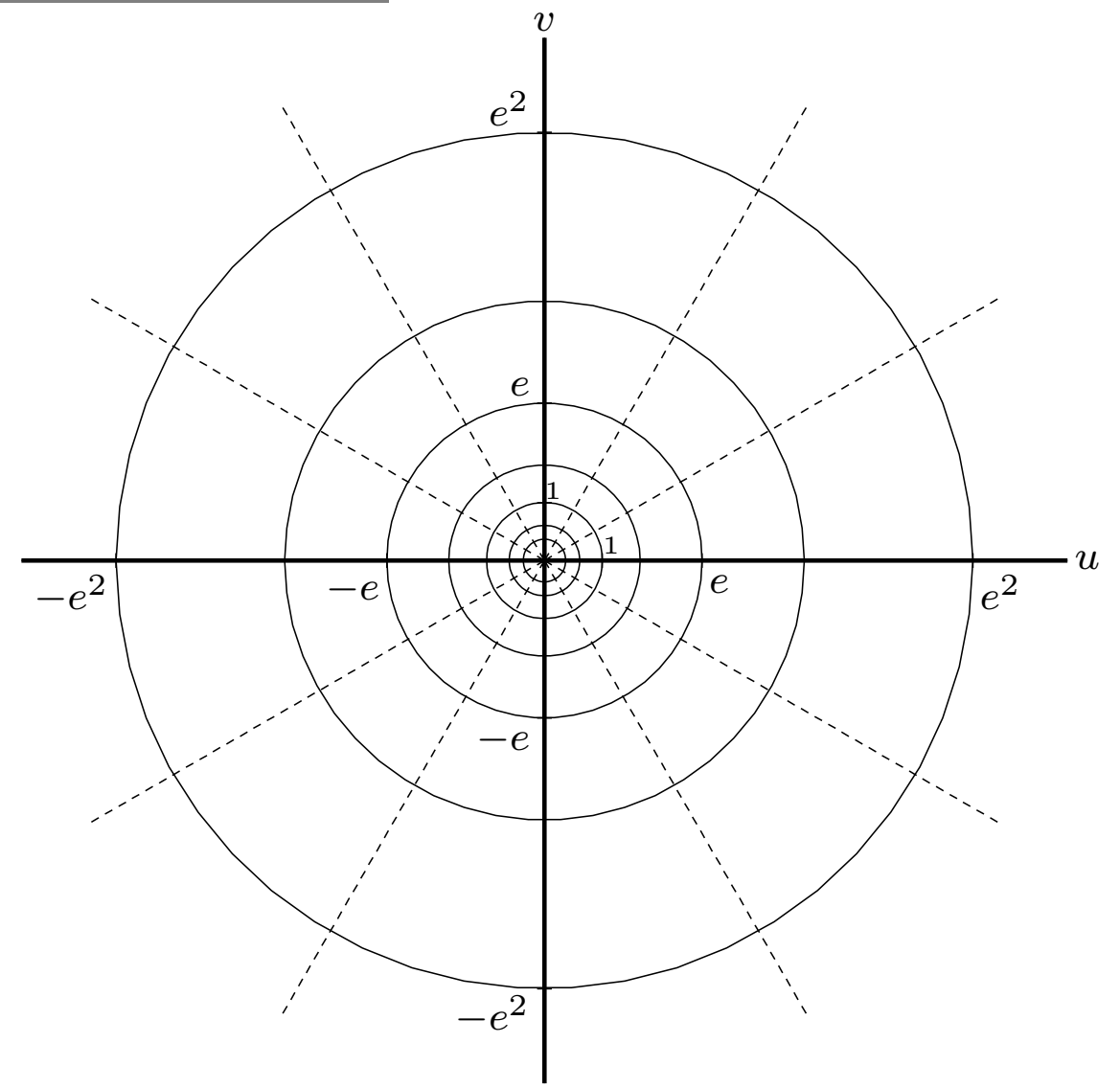
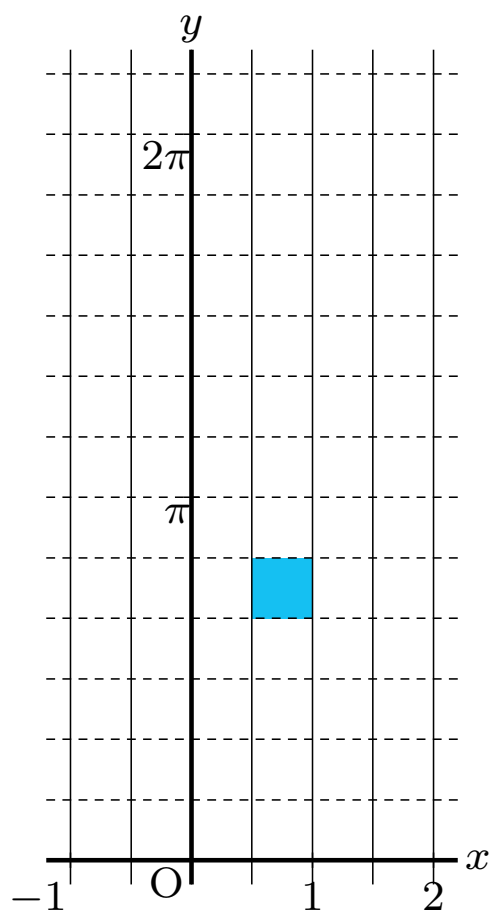

$w = e^z$ z -plane \longrightarrow w -plane

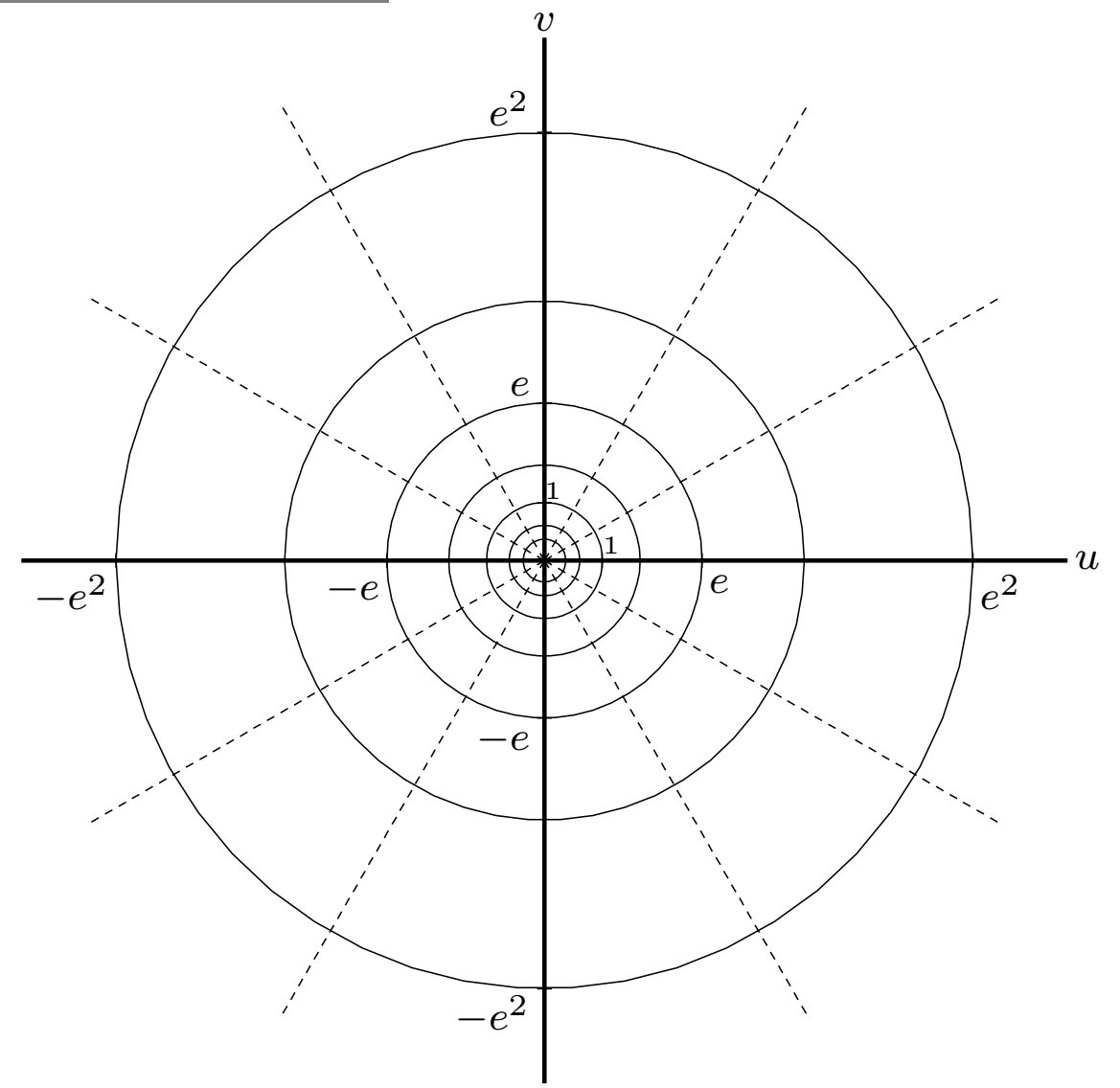
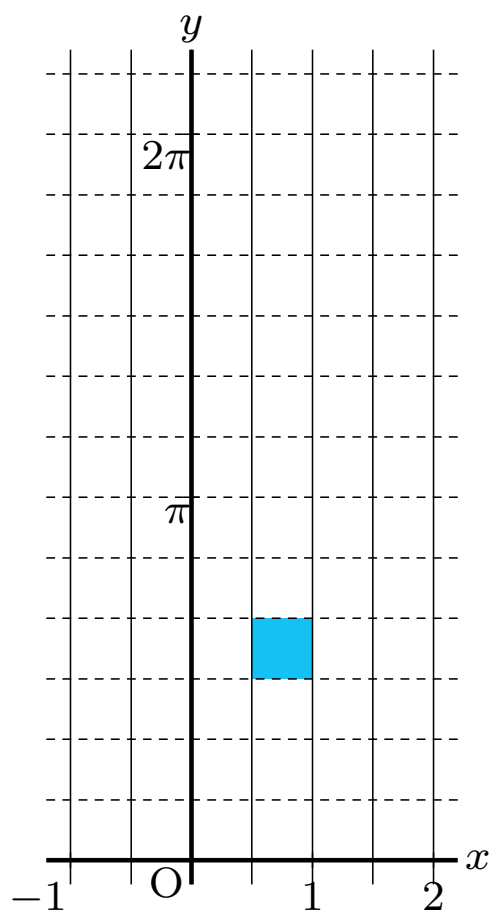

$w = e^z$ z -plane \longrightarrow w -plane

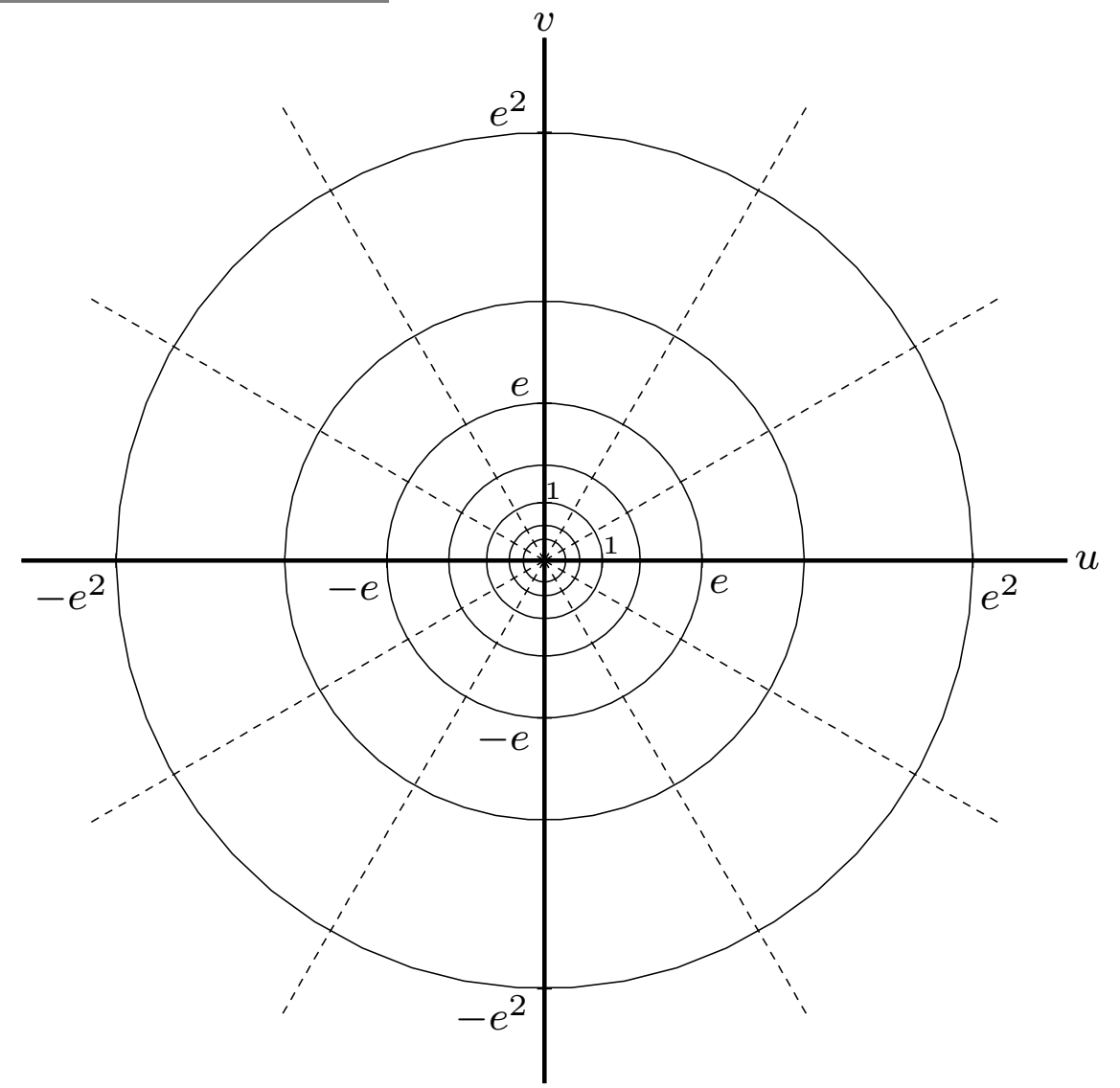
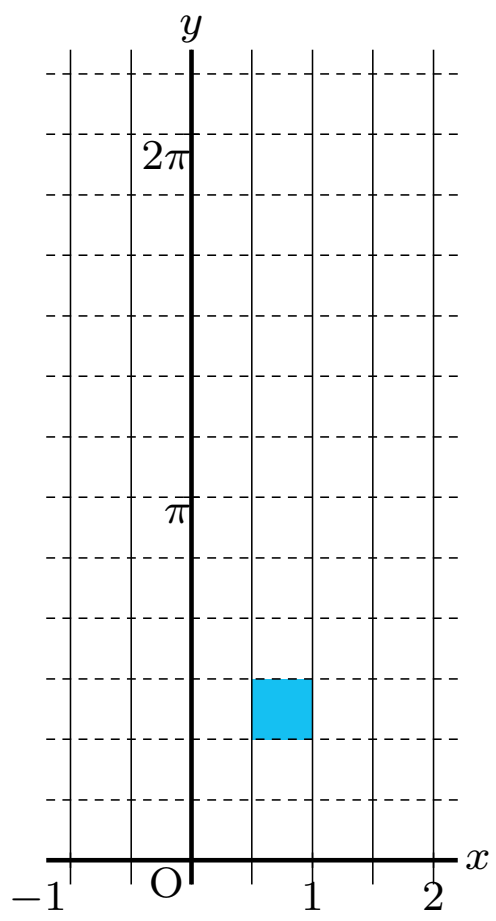

$w = e^z$ z -plane \longrightarrow w -plane

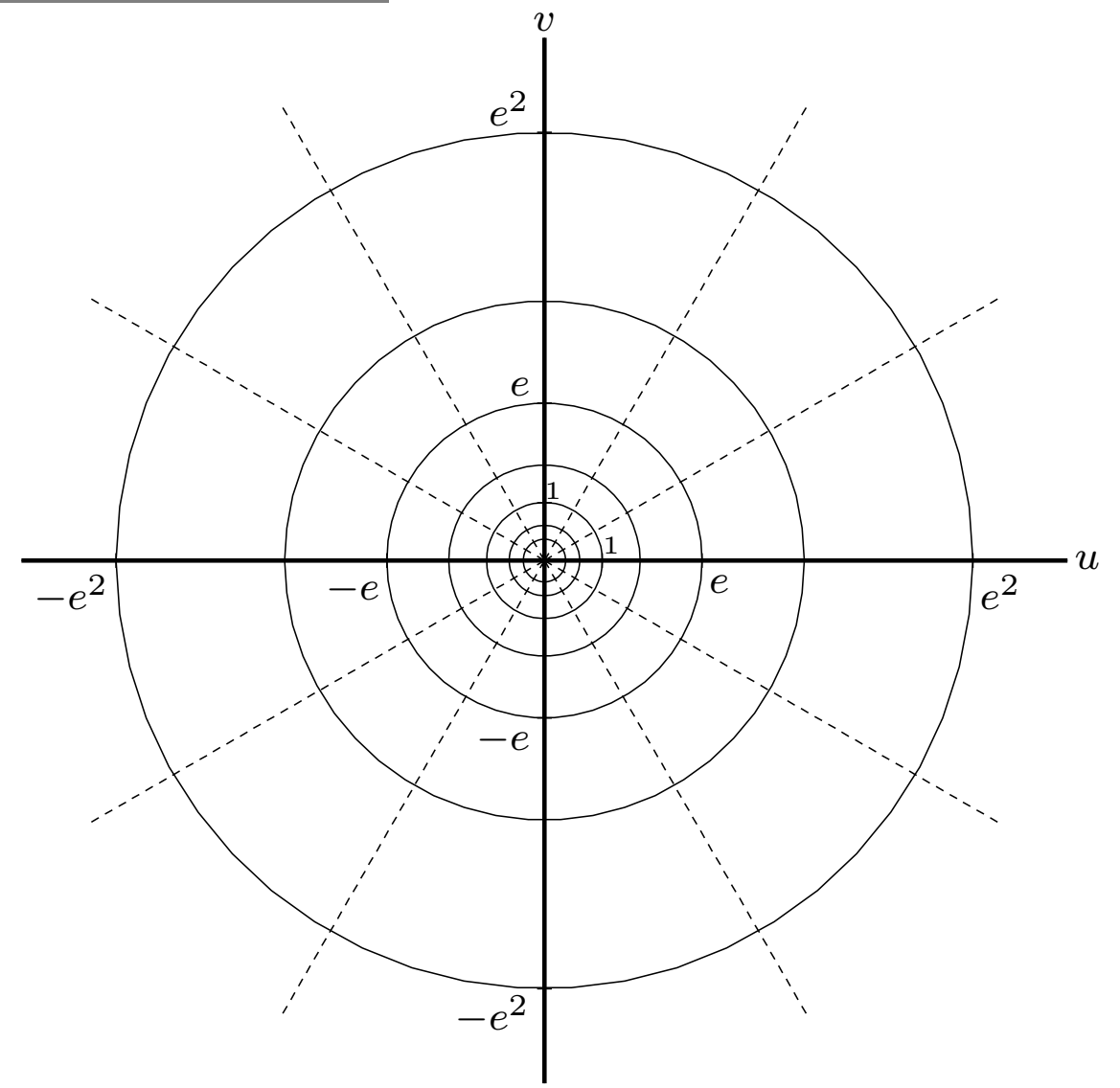
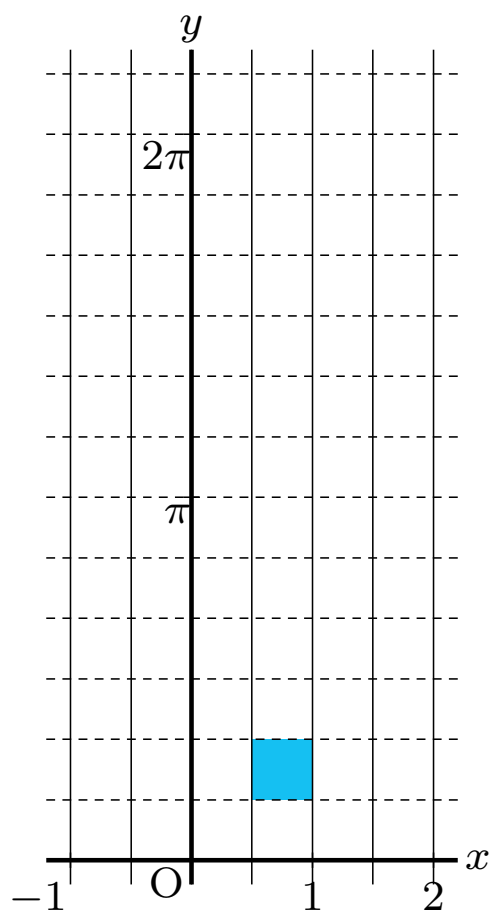

$w = e^z$ z -plane \longrightarrow w -plane

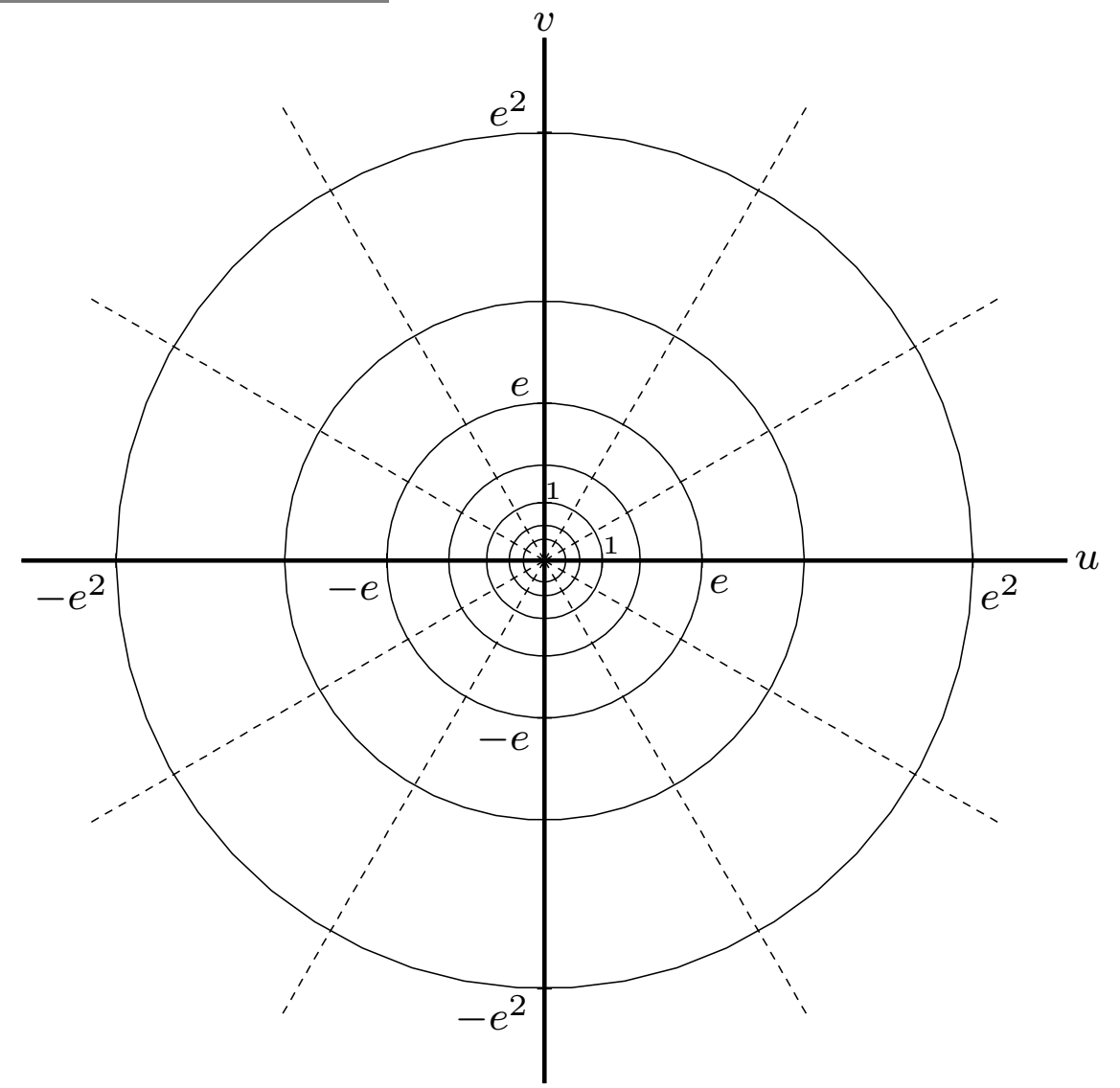
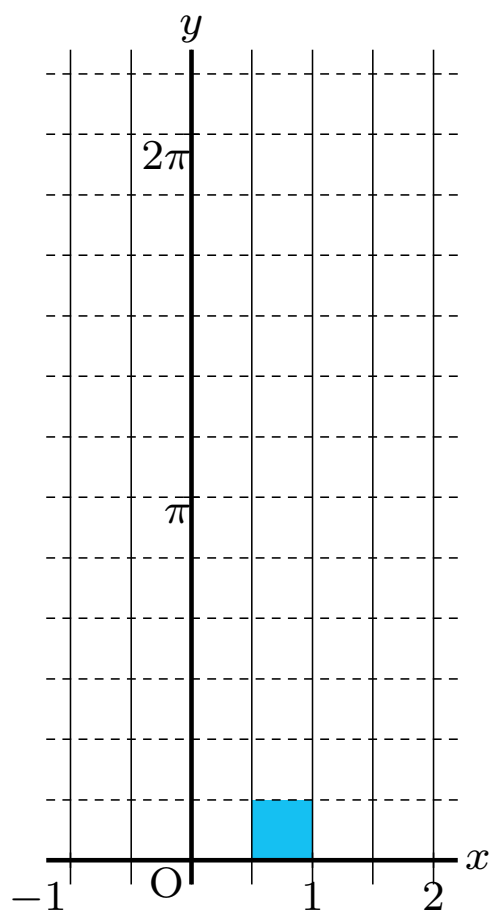

$w = e^z$ z -plane \longrightarrow w -plane

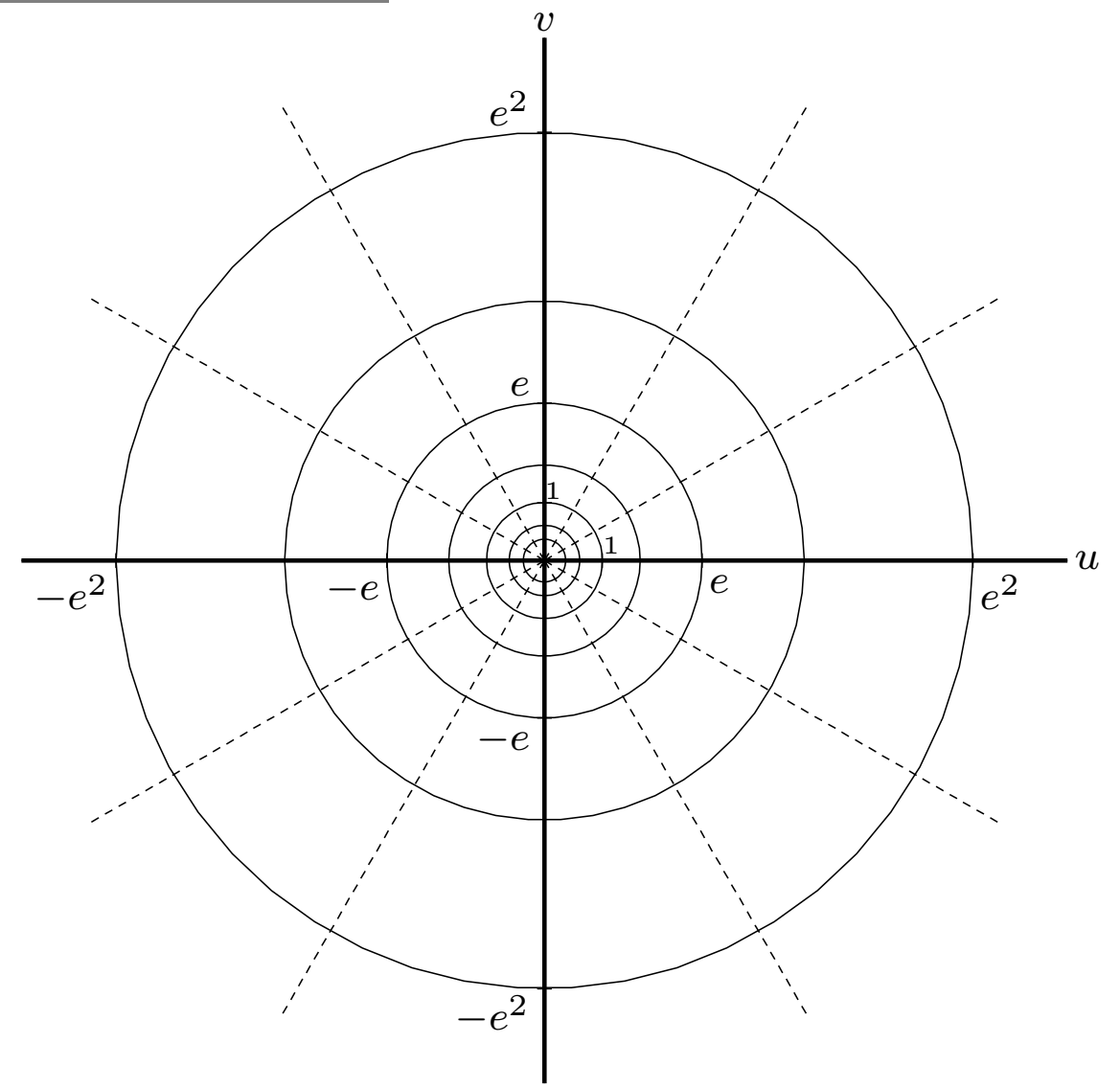
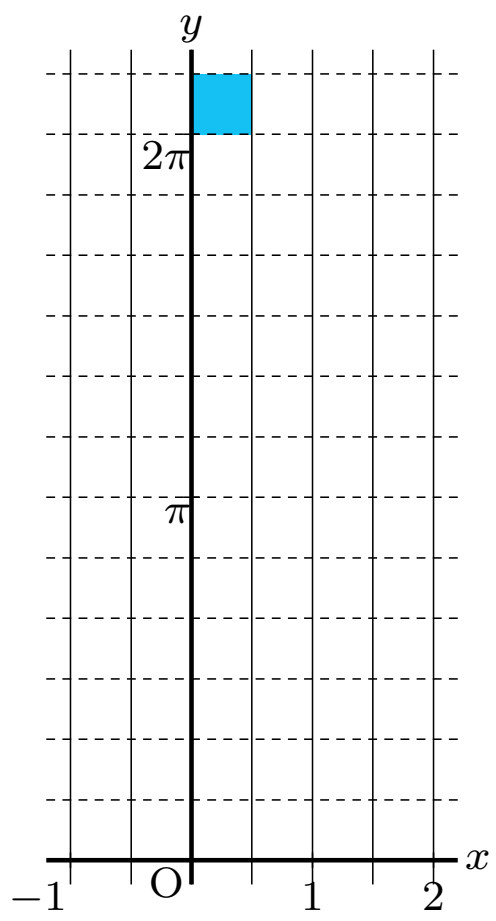

$w = e^z$ z -plane \longrightarrow w -plane

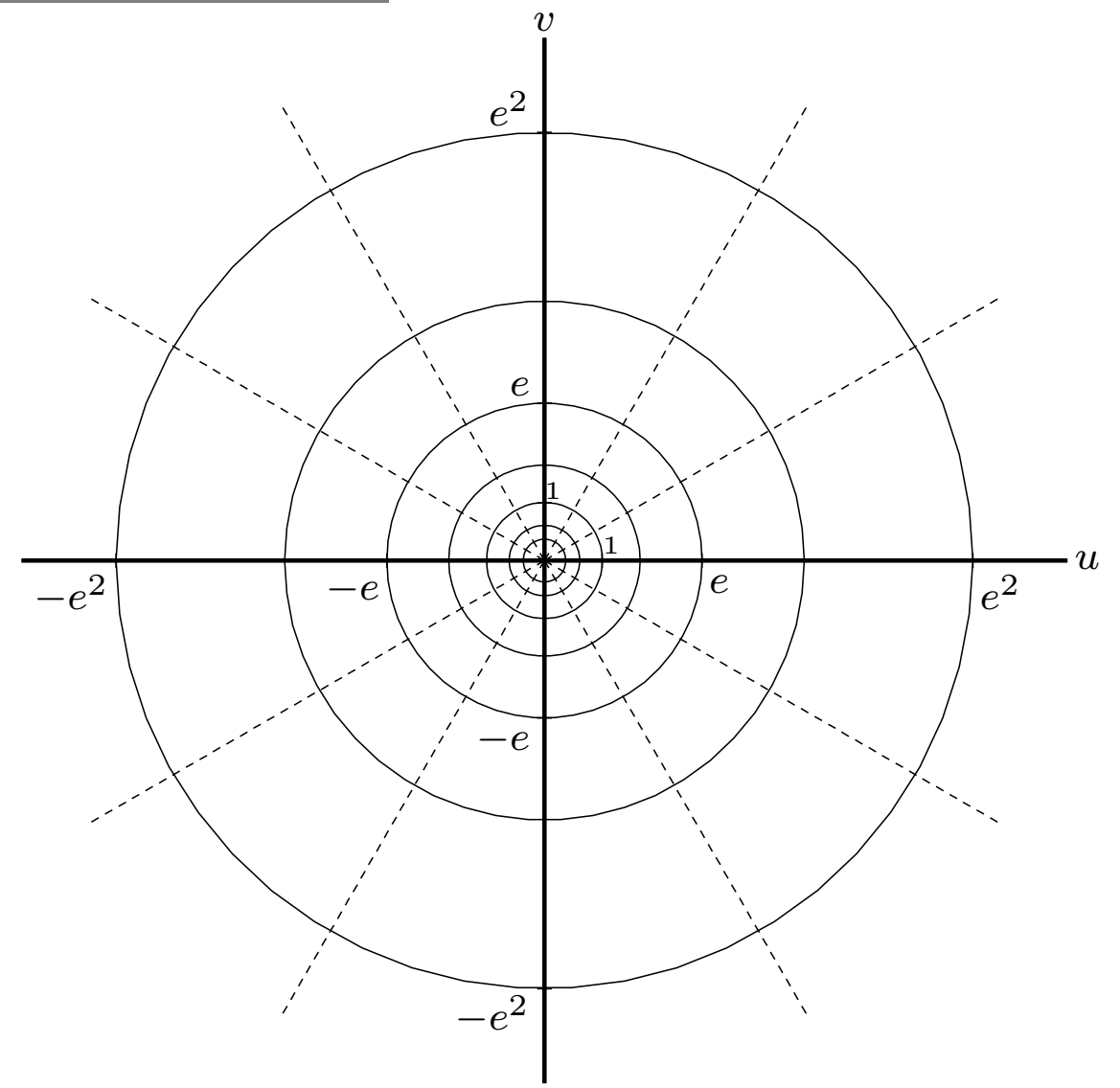
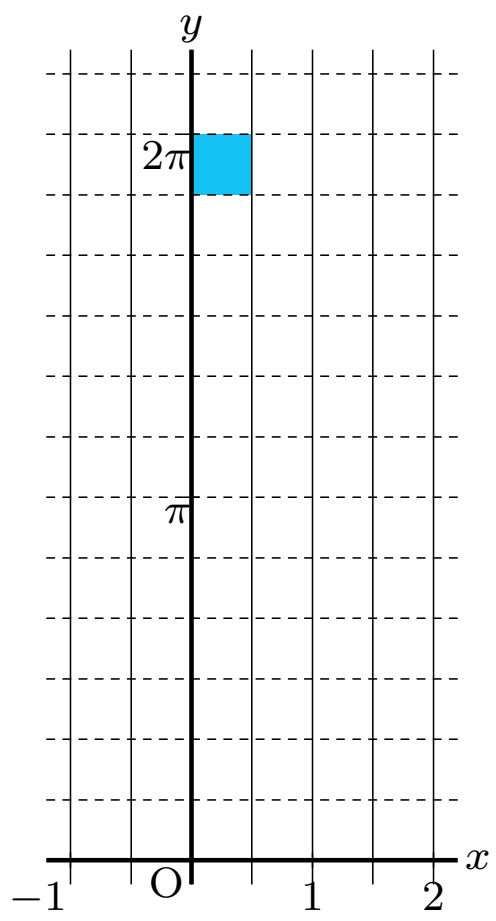

$w = e^z$ z -plane \longrightarrow w -plane

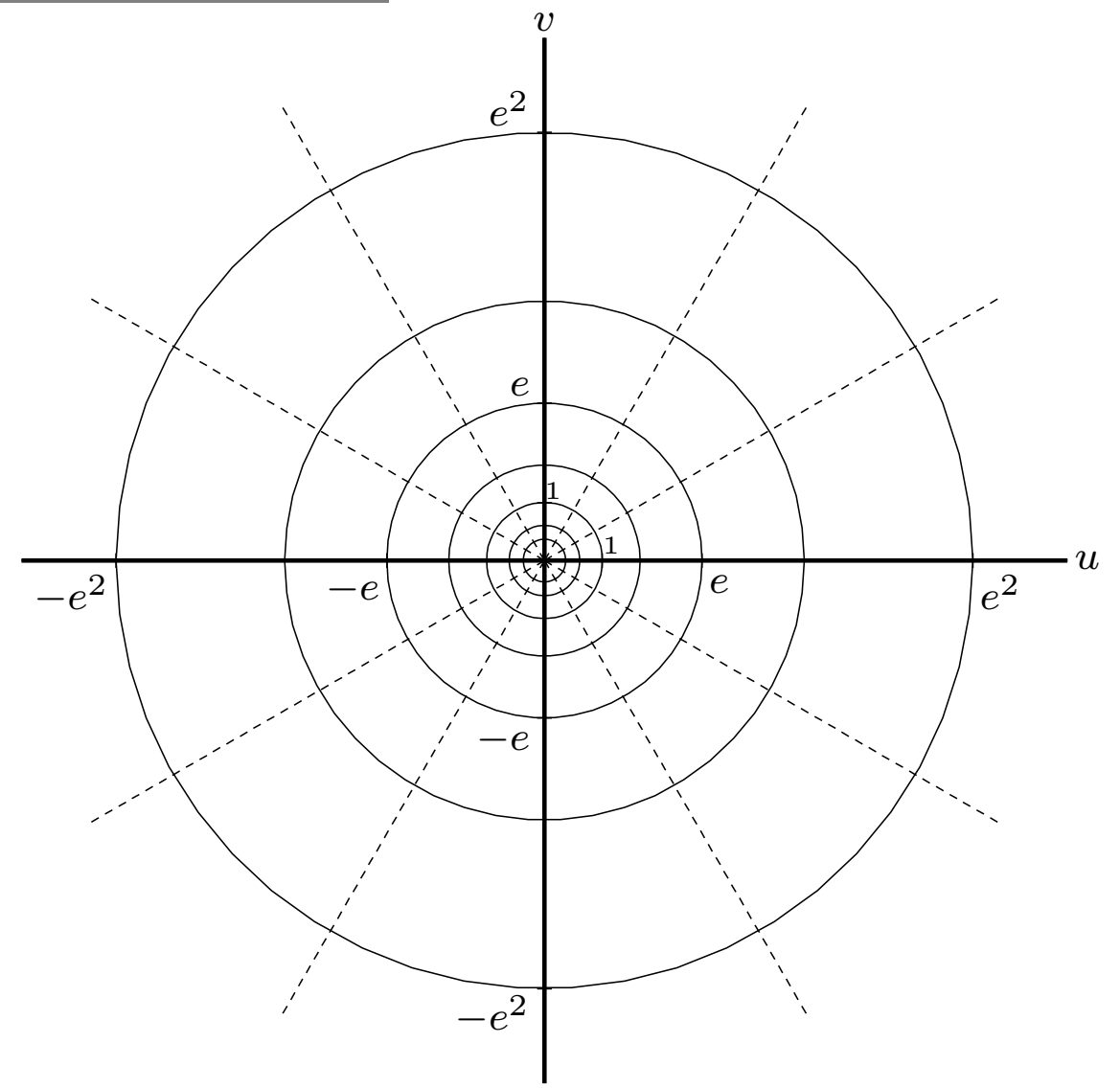
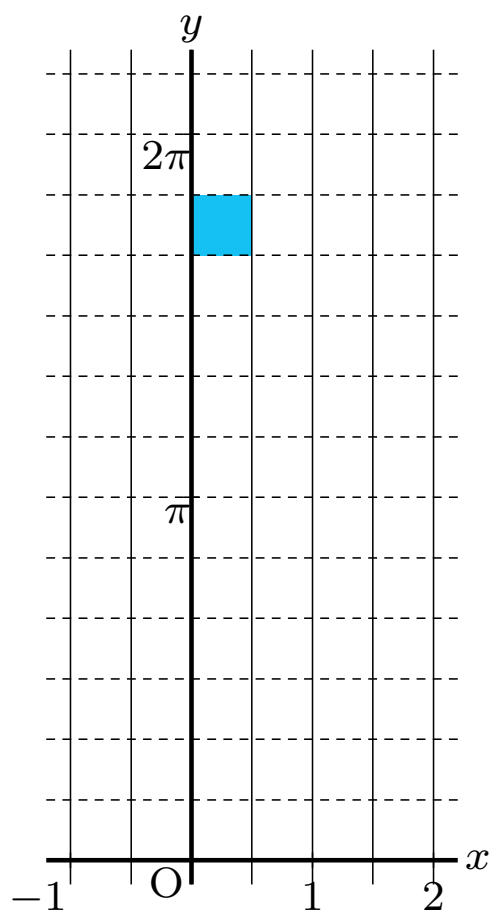

$w = e^z$ z -plane \longrightarrow w -plane

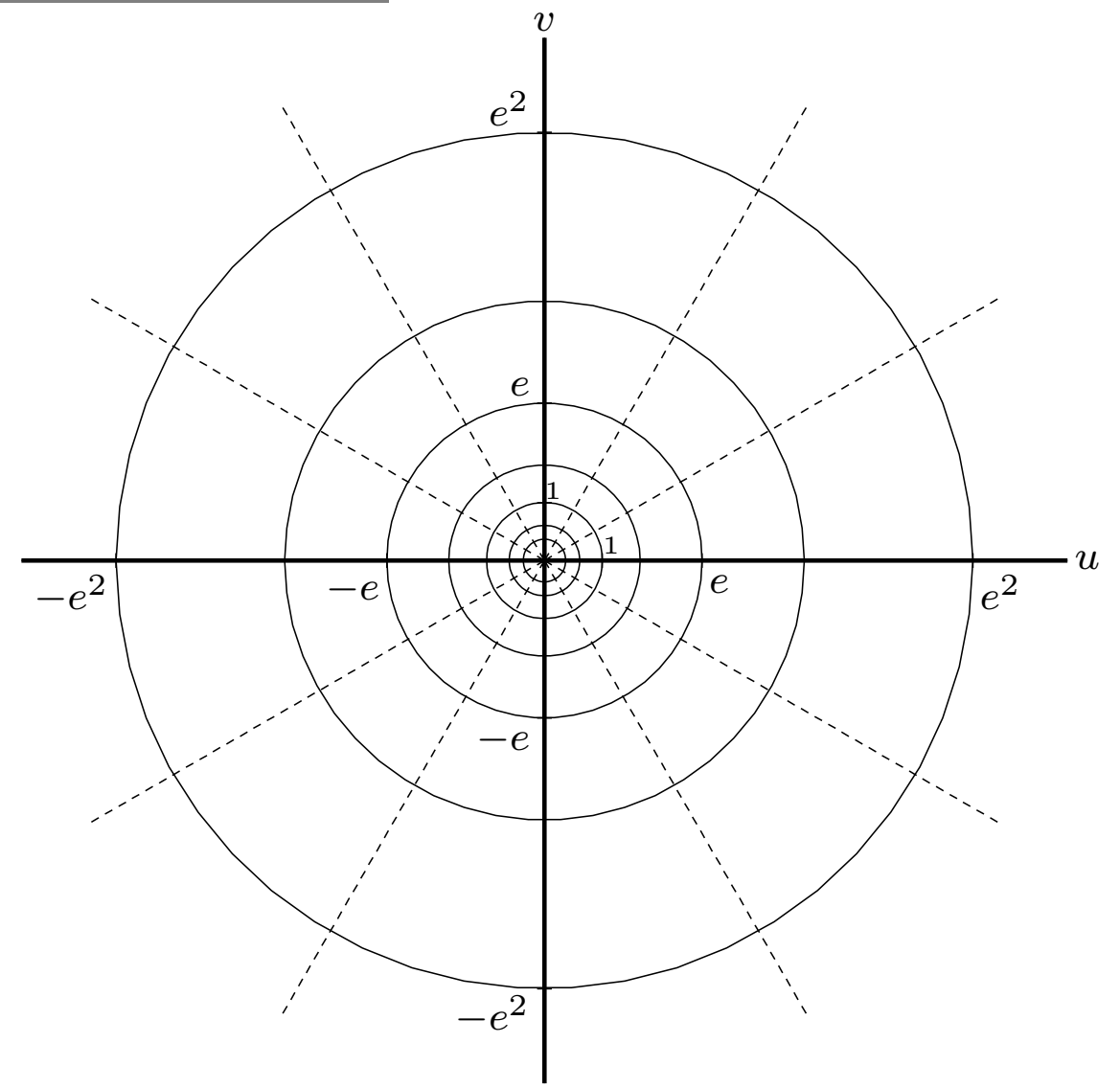
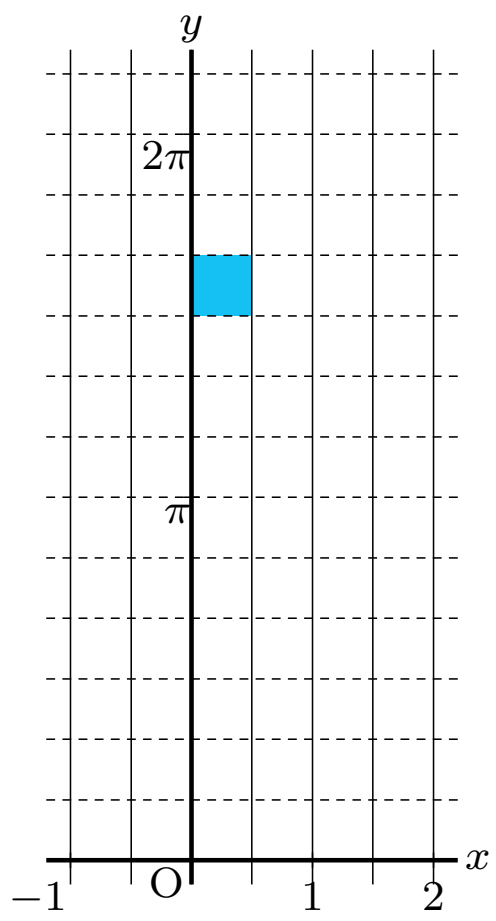

$w = e^z$ z -plane \longrightarrow w -plane

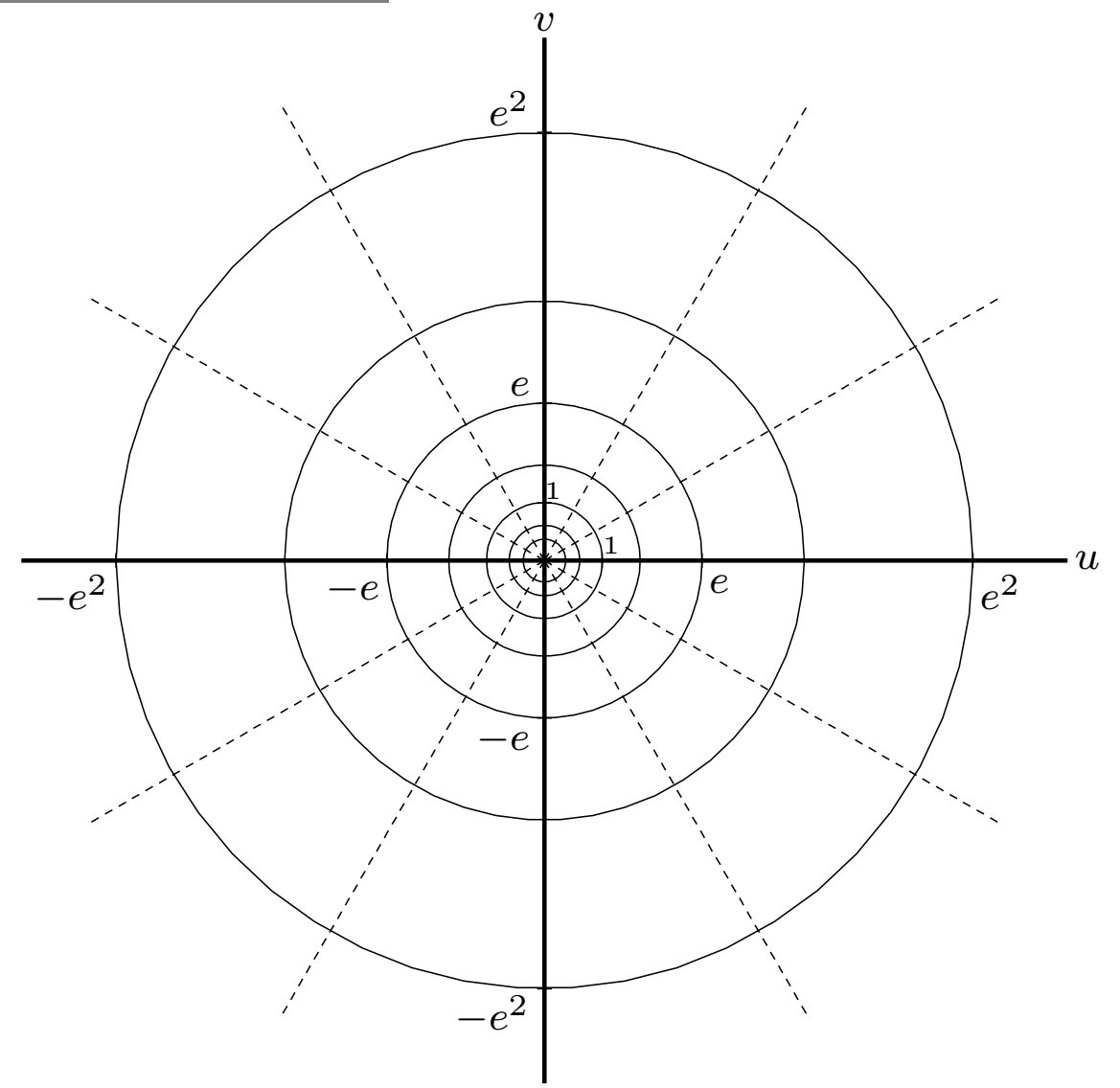
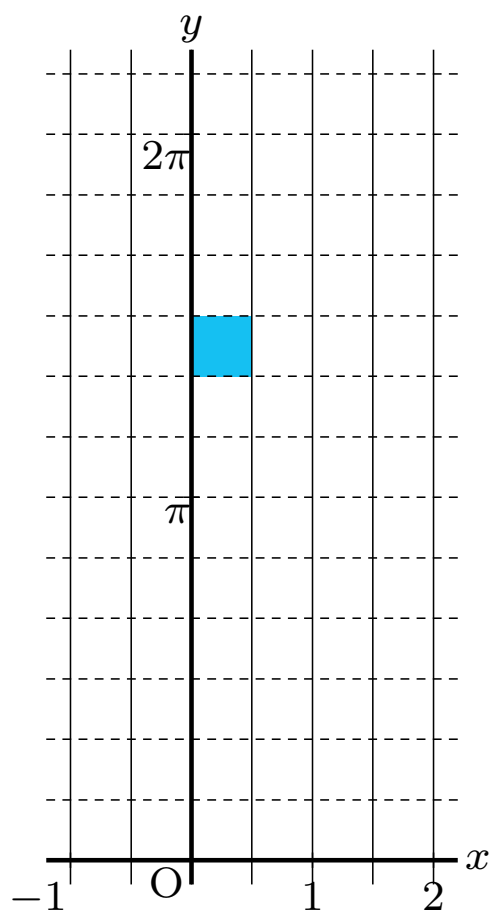

$w = e^z$ z -plane \longrightarrow w -plane

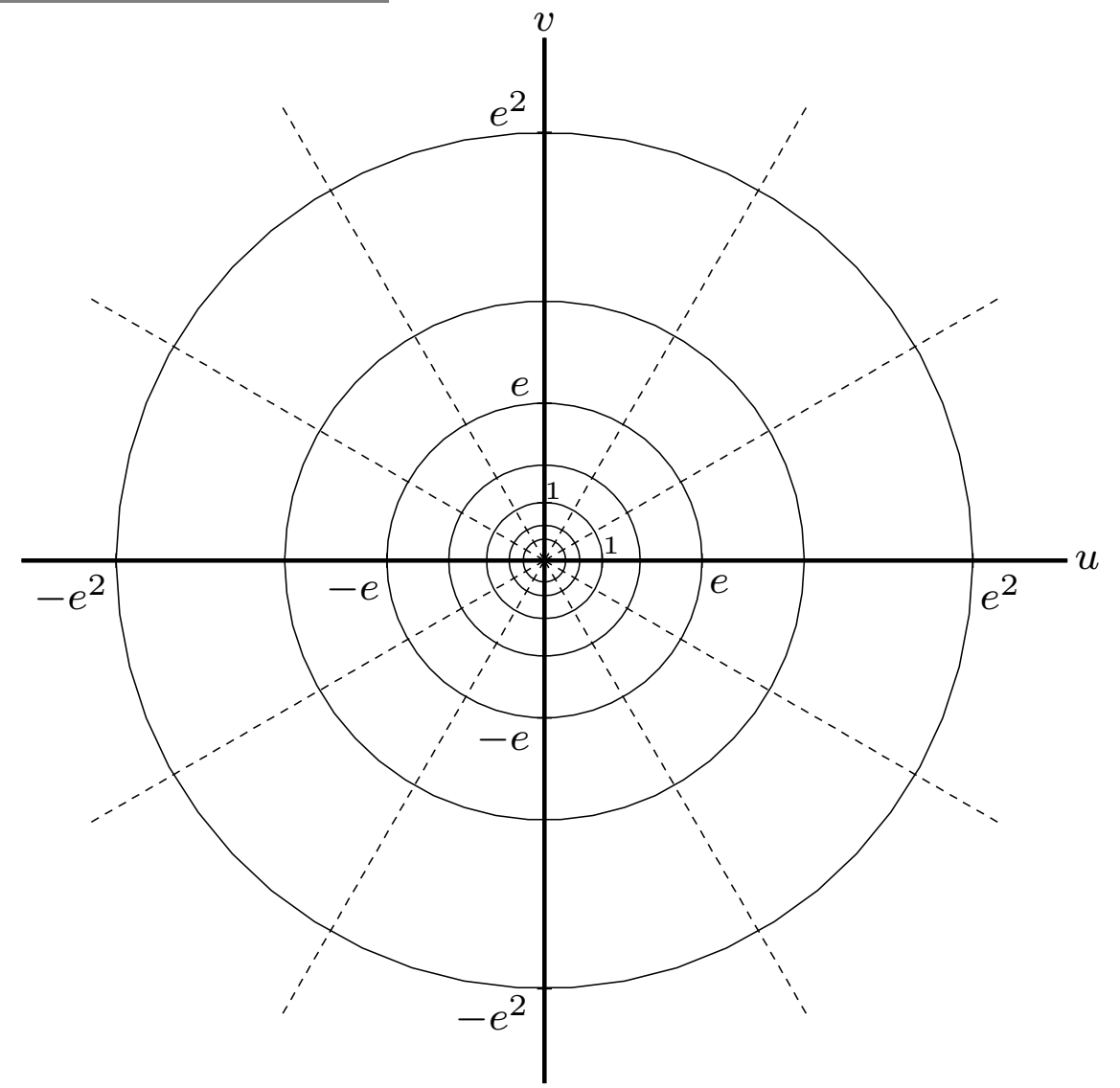
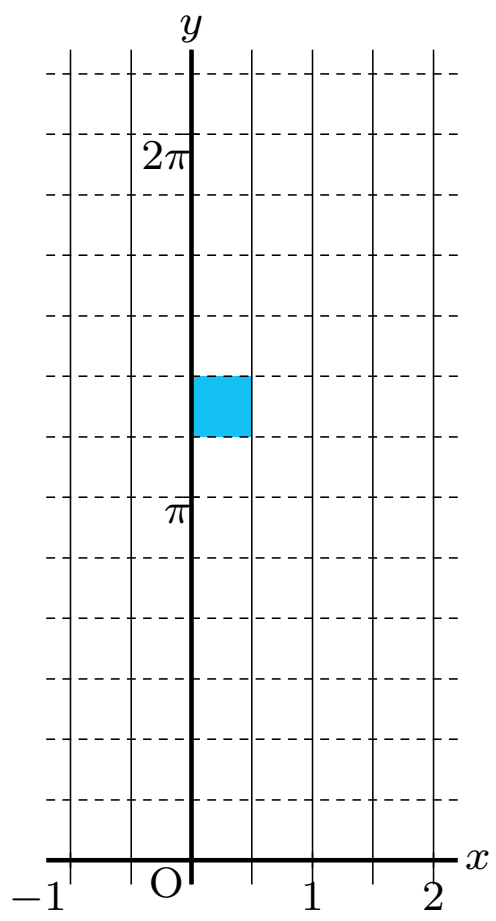

$w = e^z$ z -plane \longrightarrow w -plane

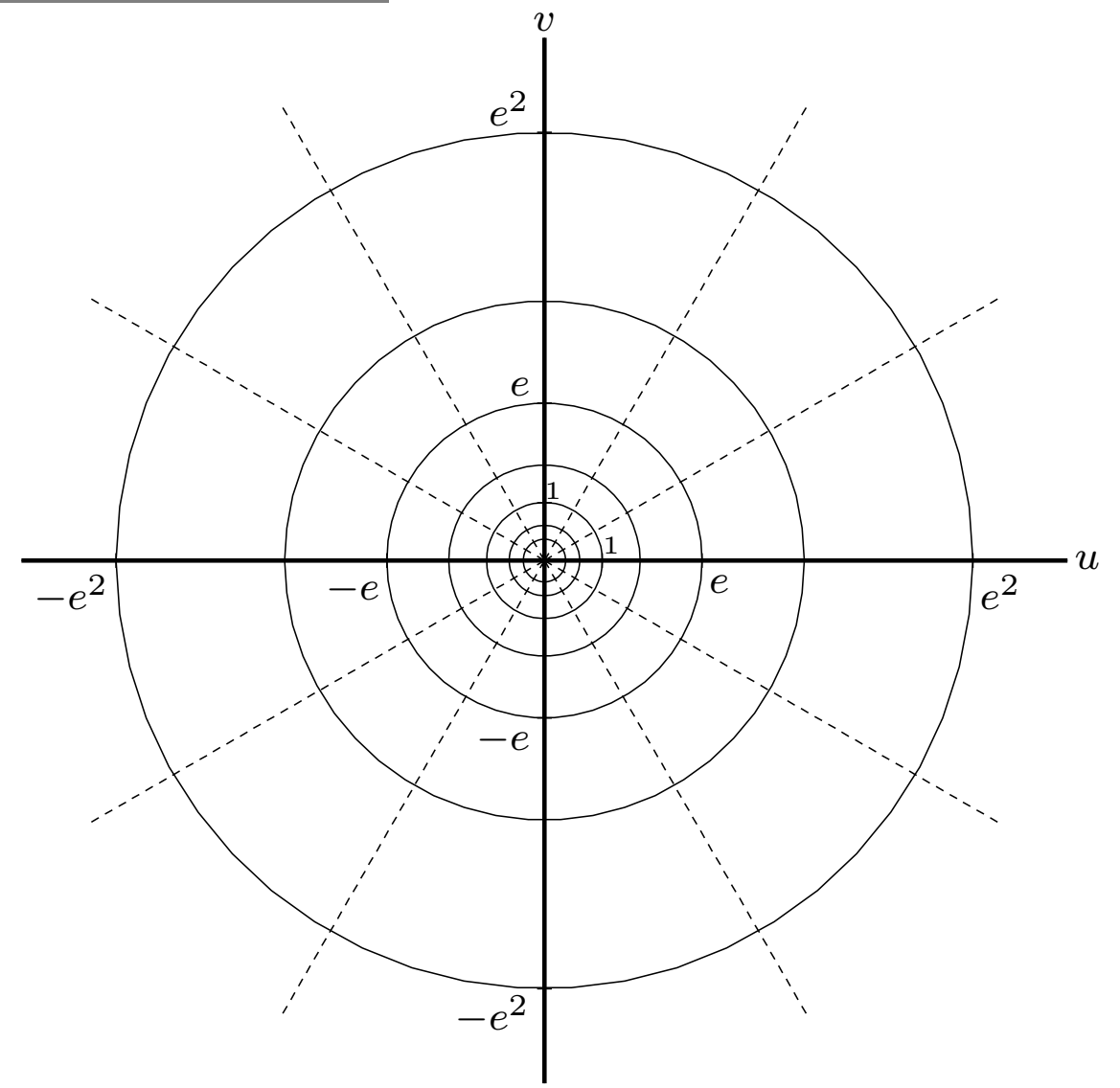
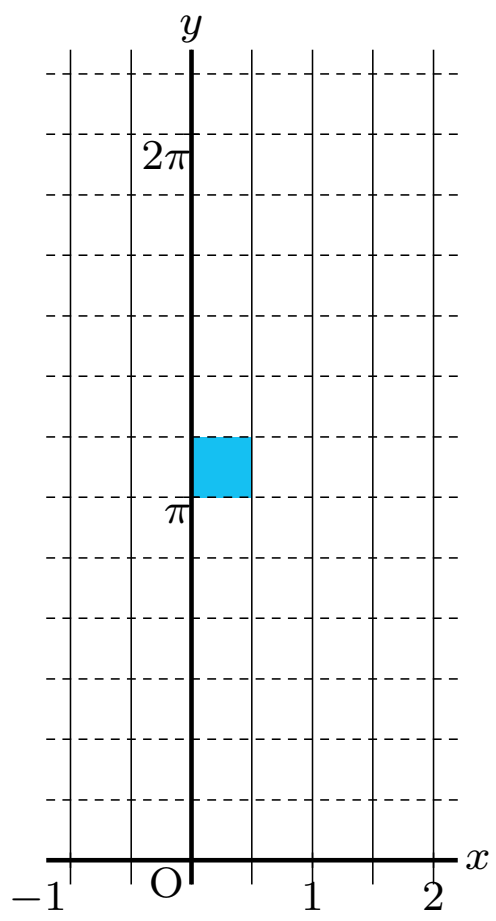

$w = e^z$ z -plane \longrightarrow w -plane

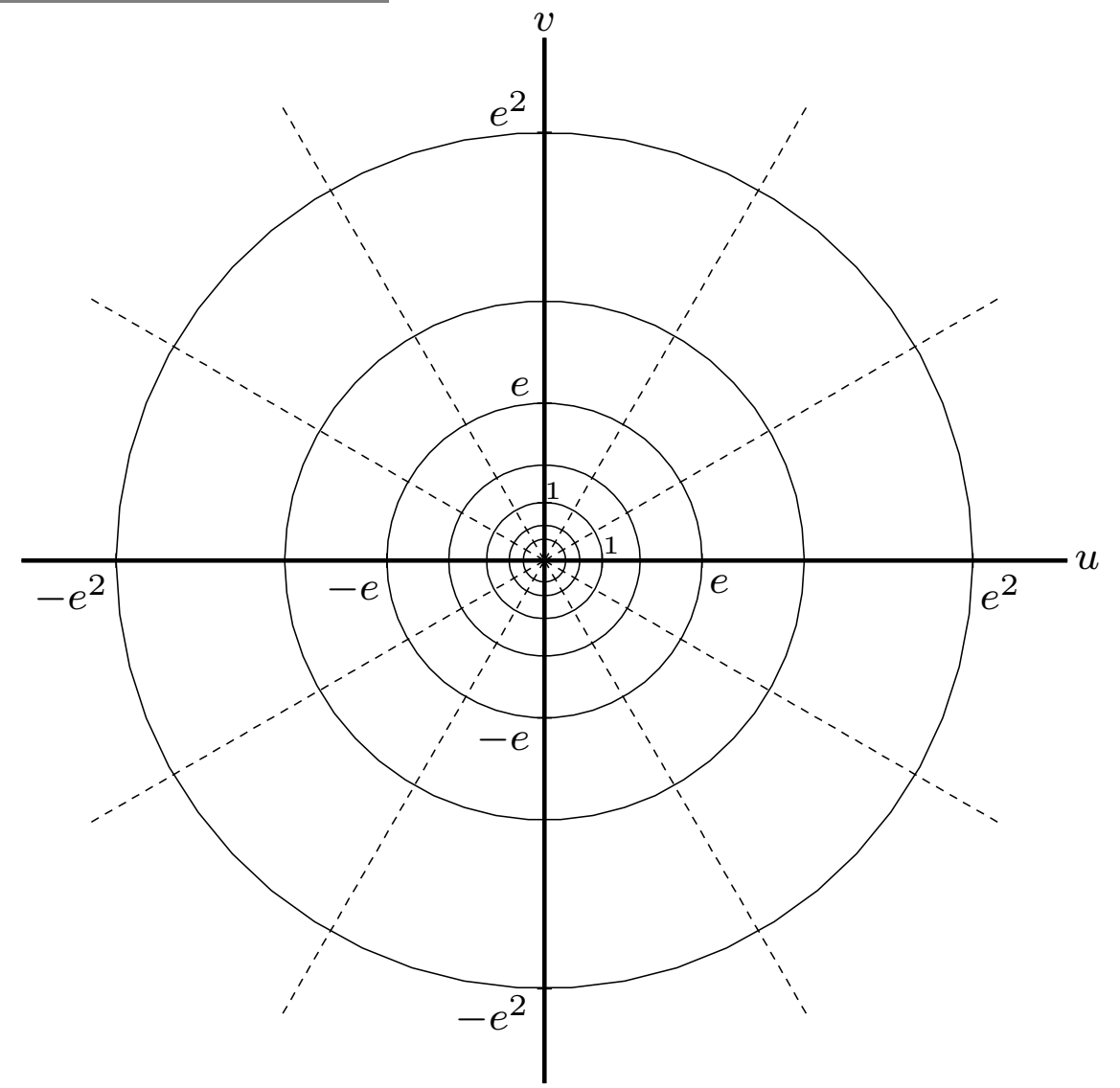
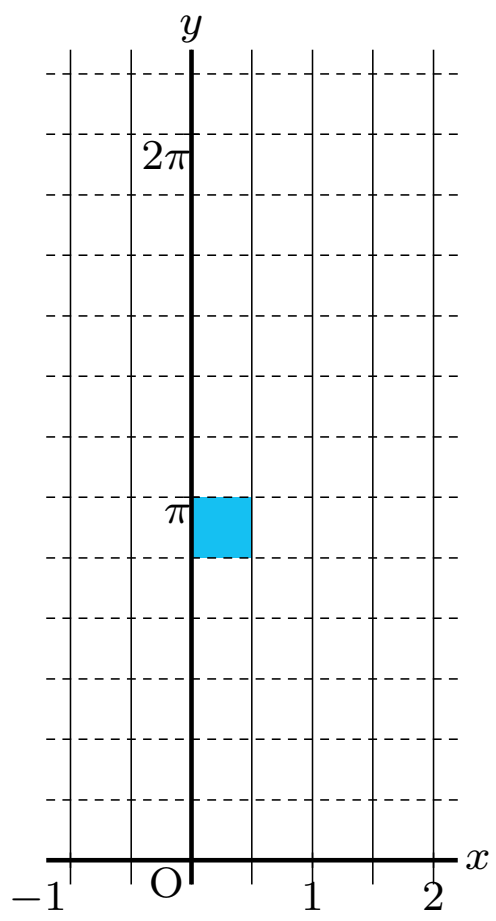

$w = e^z$ z -plane \longrightarrow w -plane

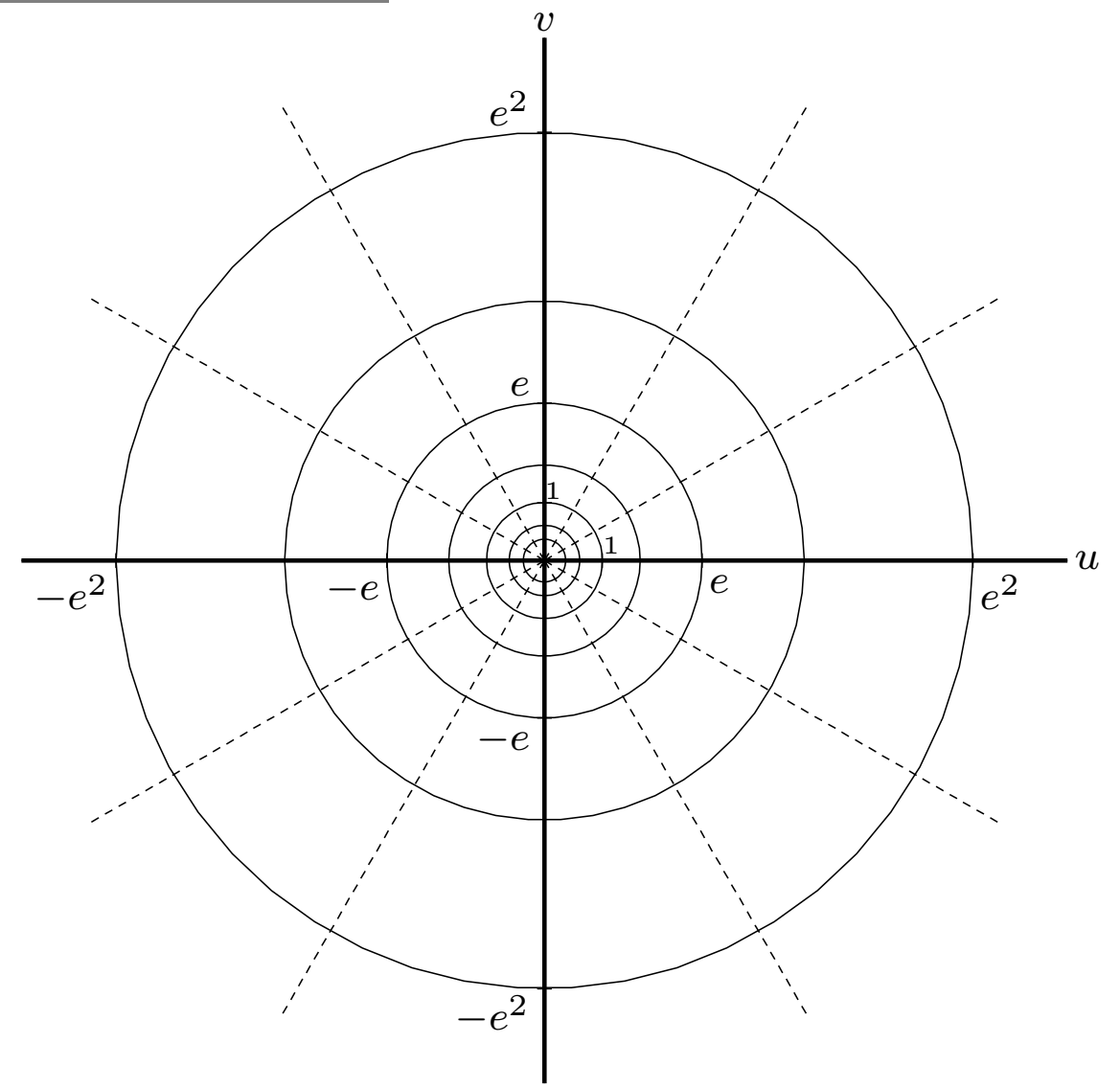
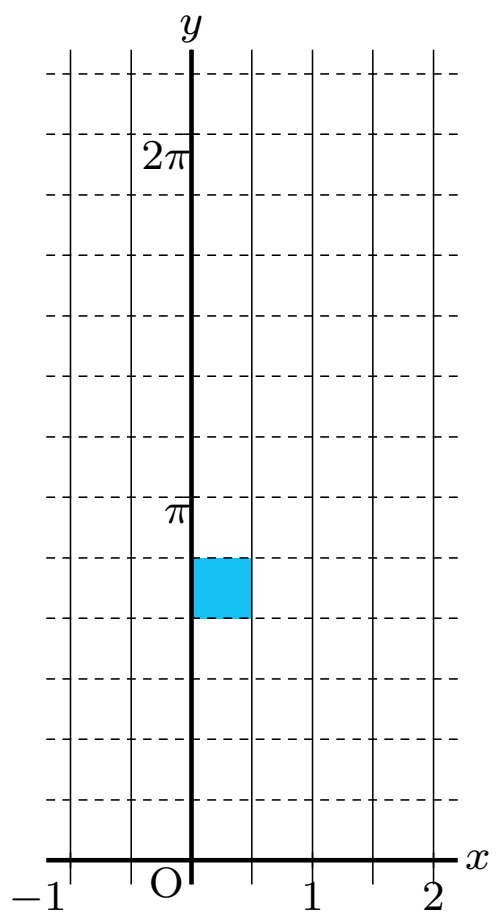

$w = e^z$ z -plane \longrightarrow w -plane

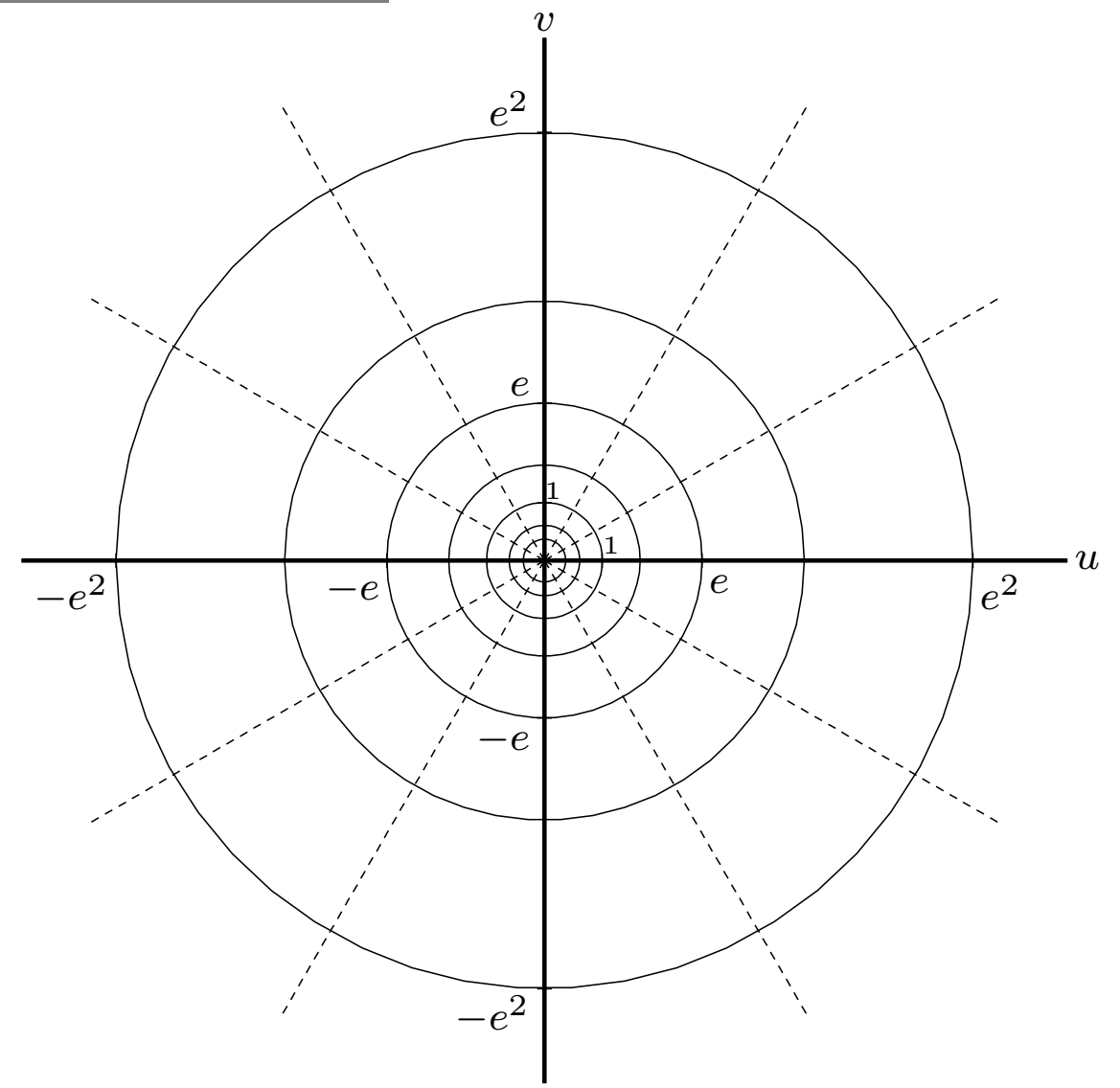
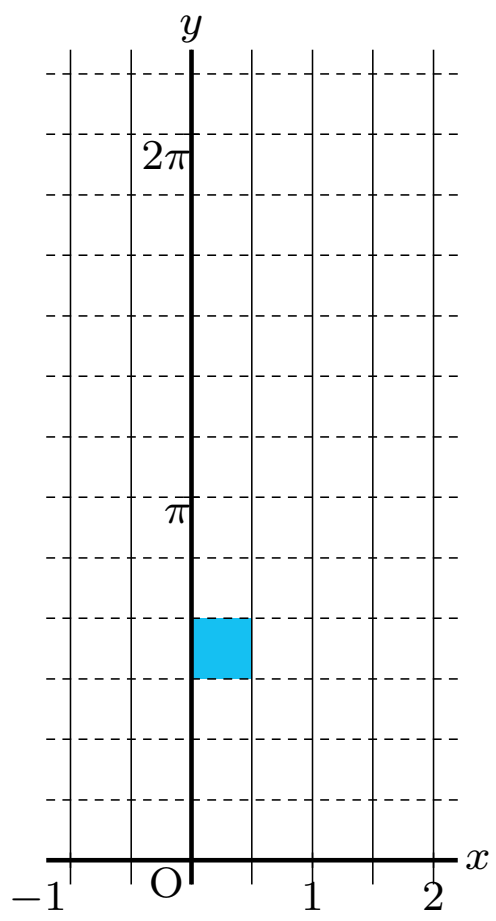

$w = e^z$ z -plane \longrightarrow w -plane

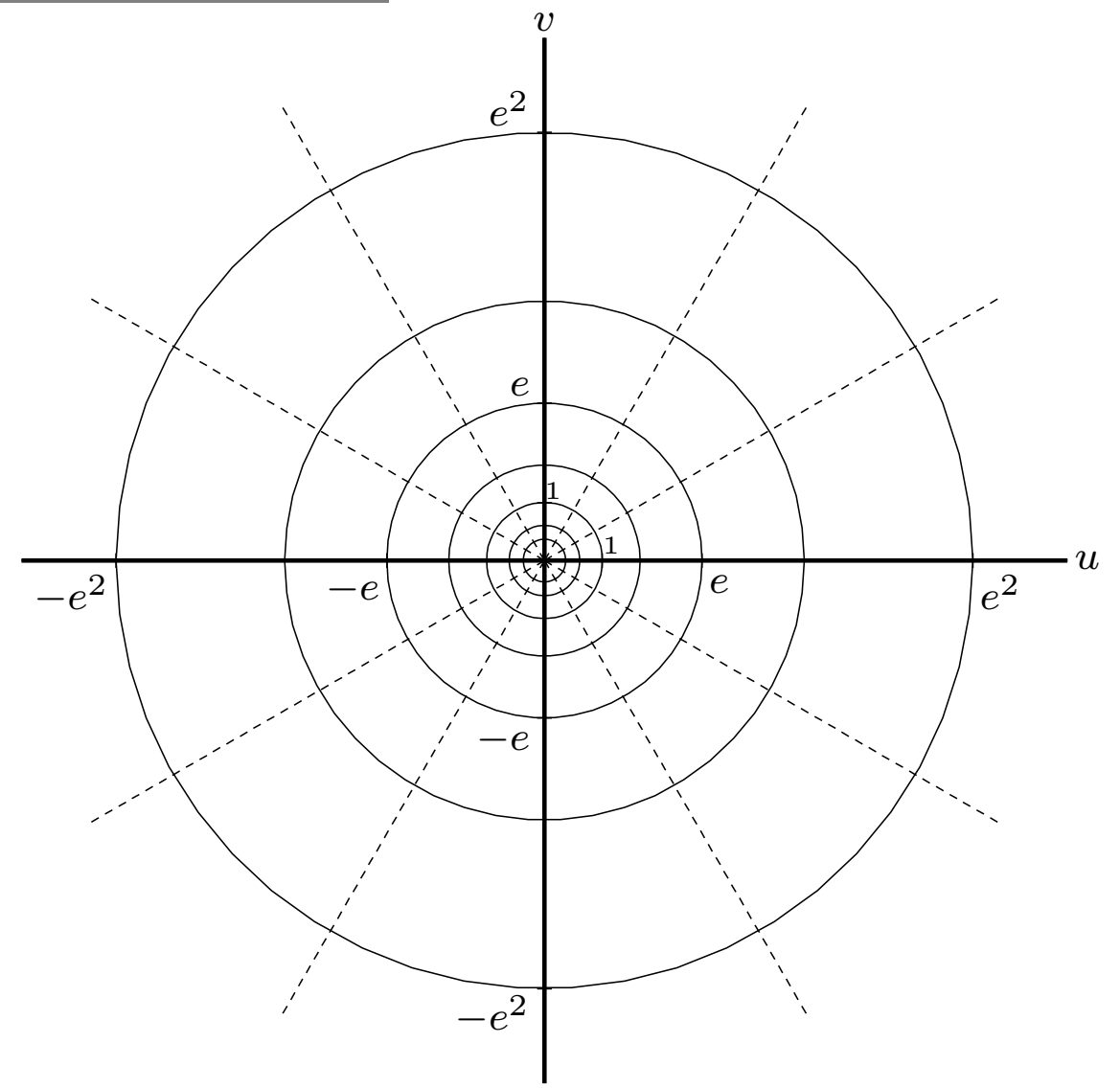
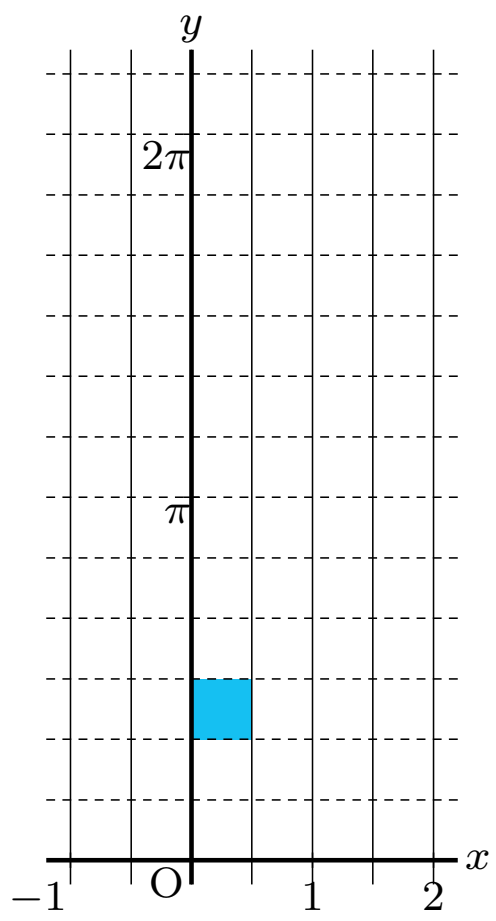

$w = e^z$ z -plane \longrightarrow w -plane

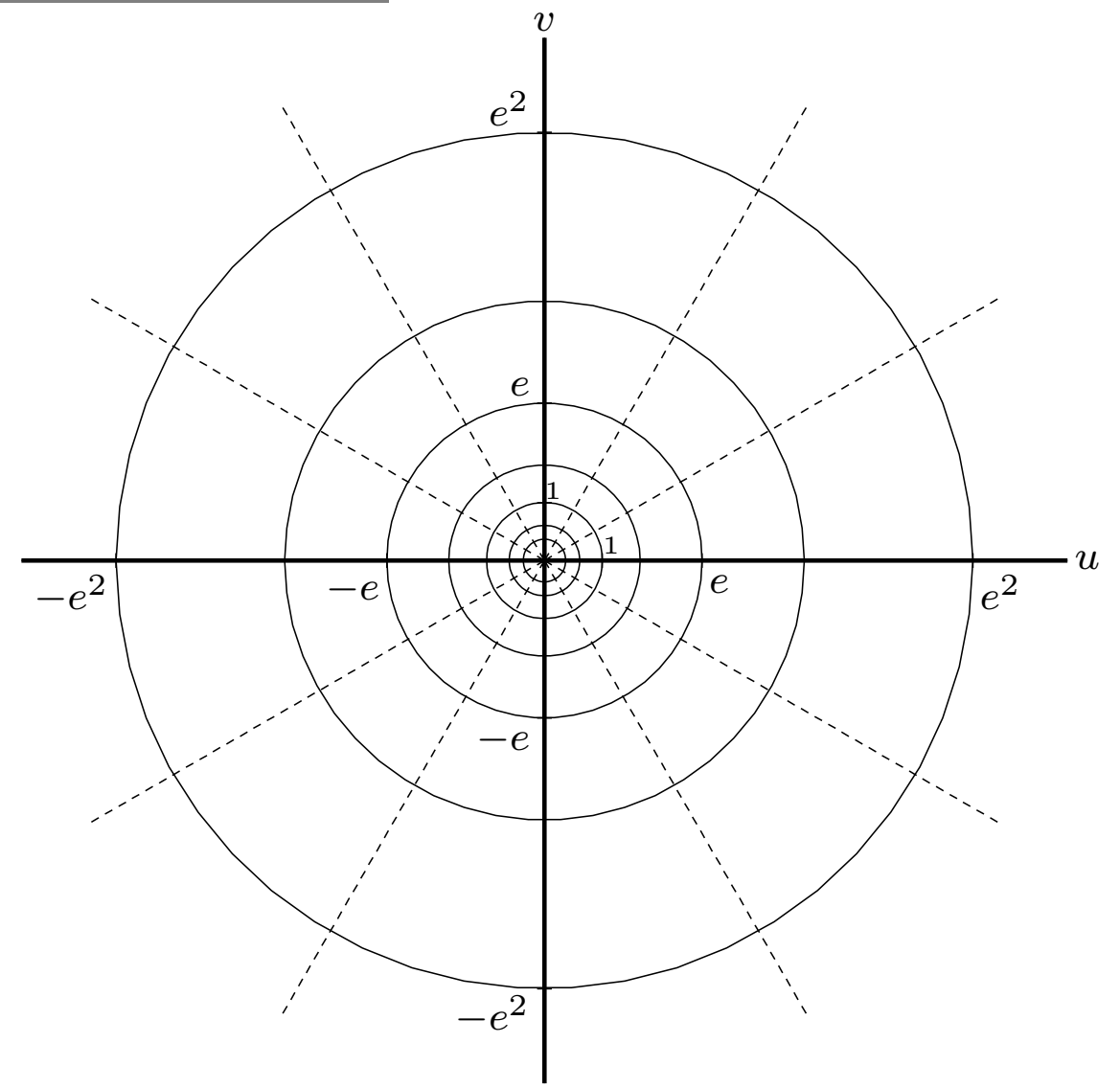
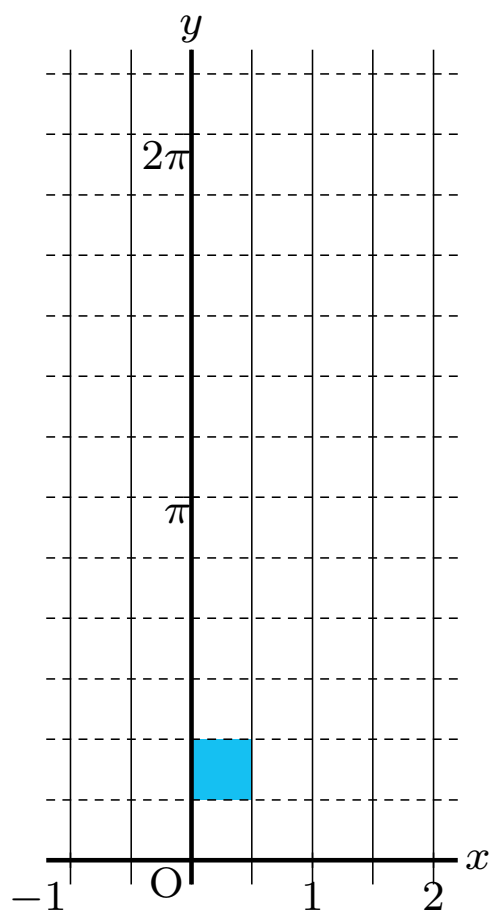

$w = e^z$ z -plane \longrightarrow w -plane

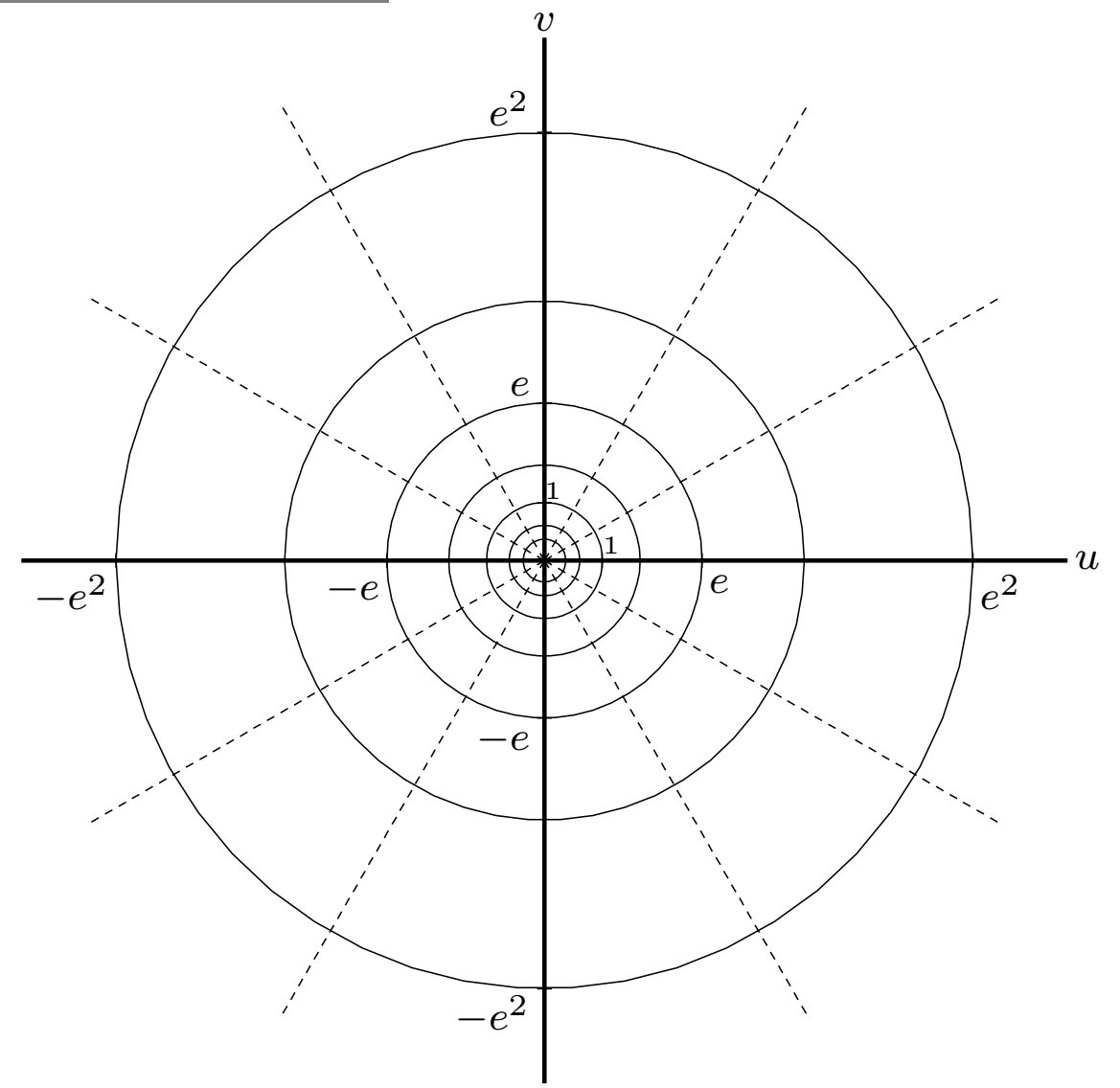
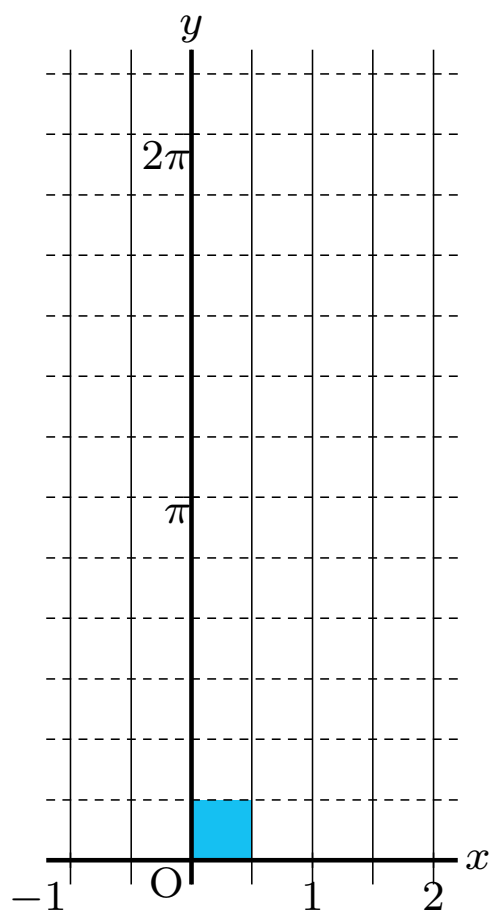

$w = e^z$ z -plane \longrightarrow w -plane

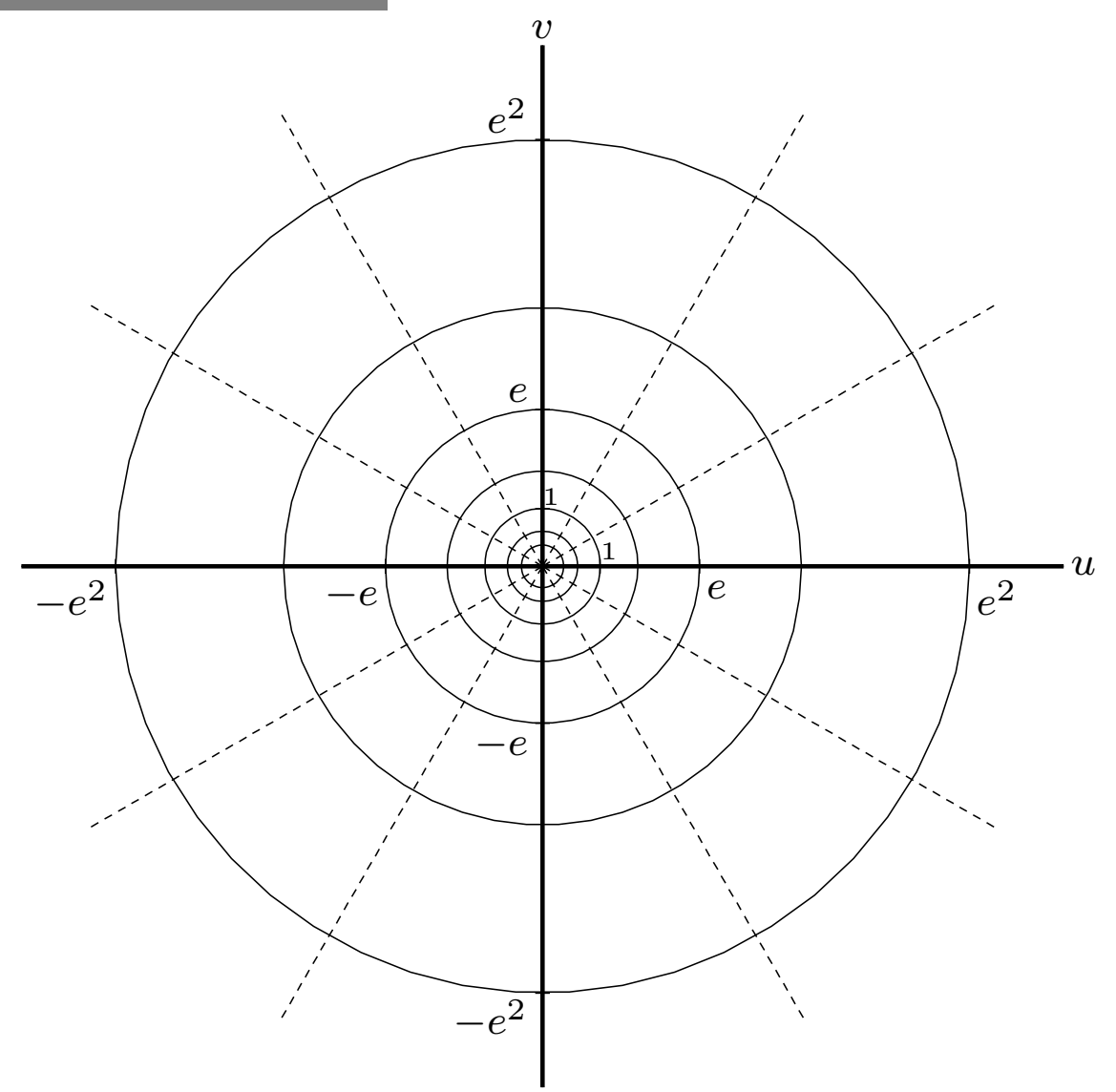
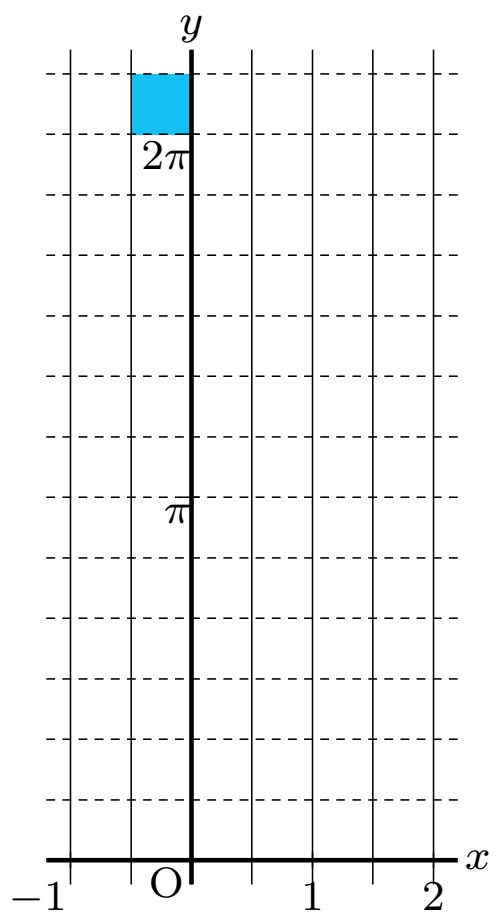

$w = e^z$ z -plane \longrightarrow w -plane

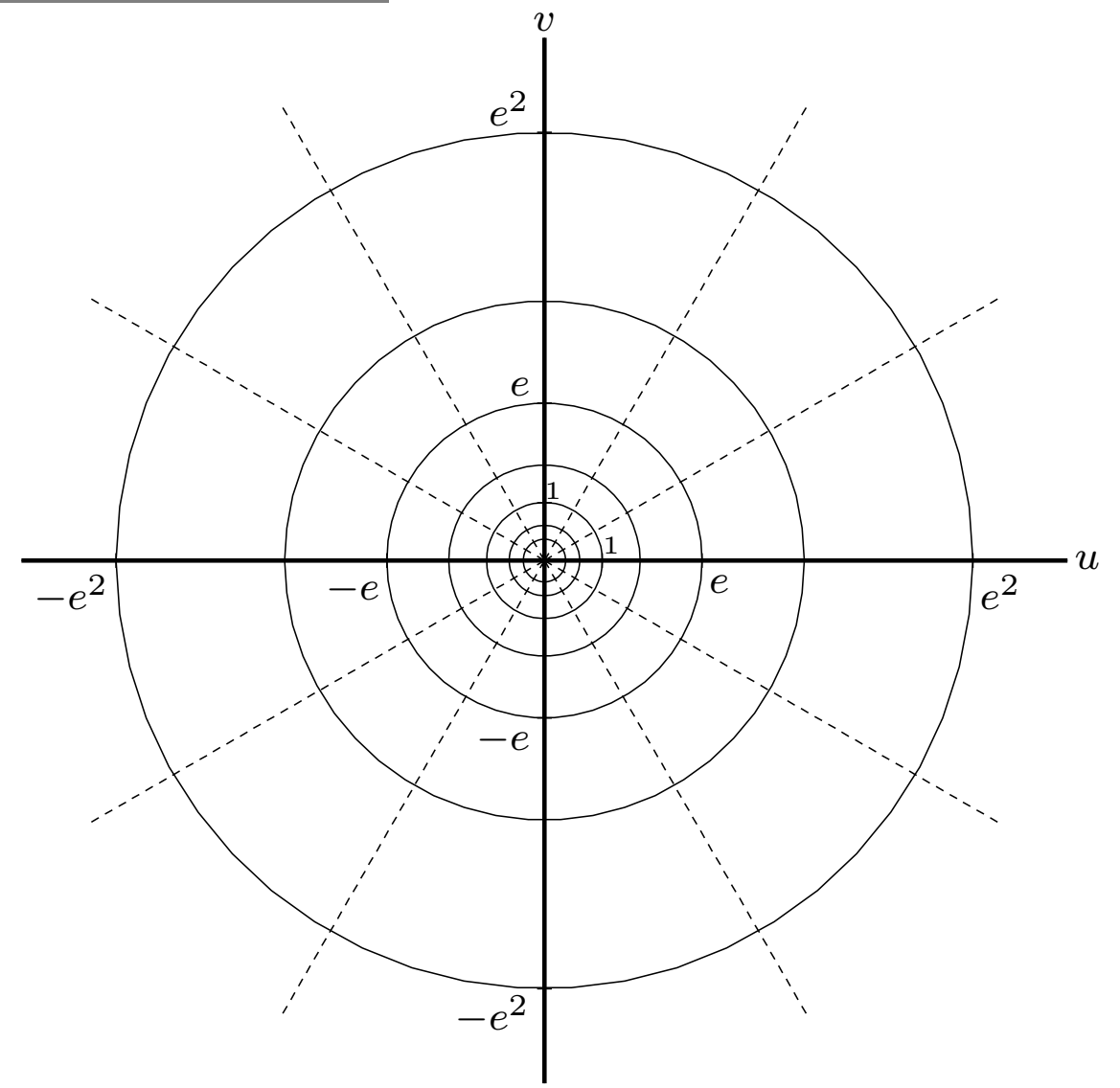
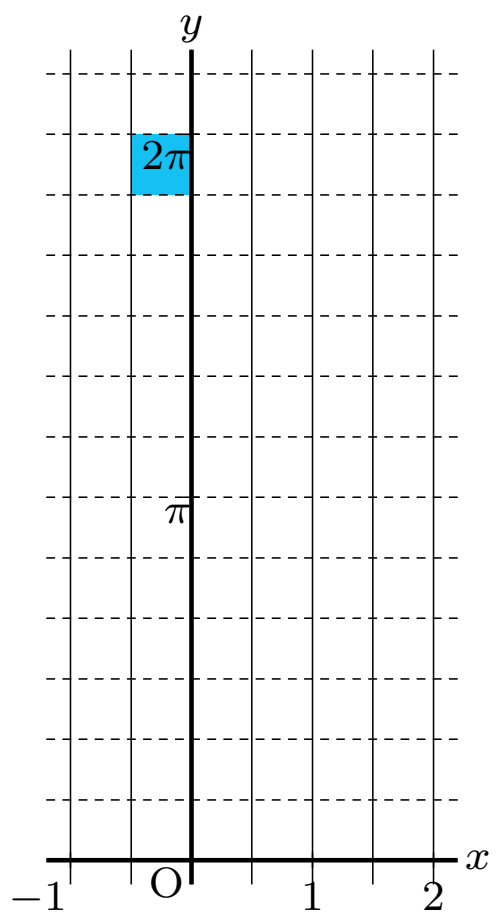

$w = e^z$ z -plane \longrightarrow w -plane

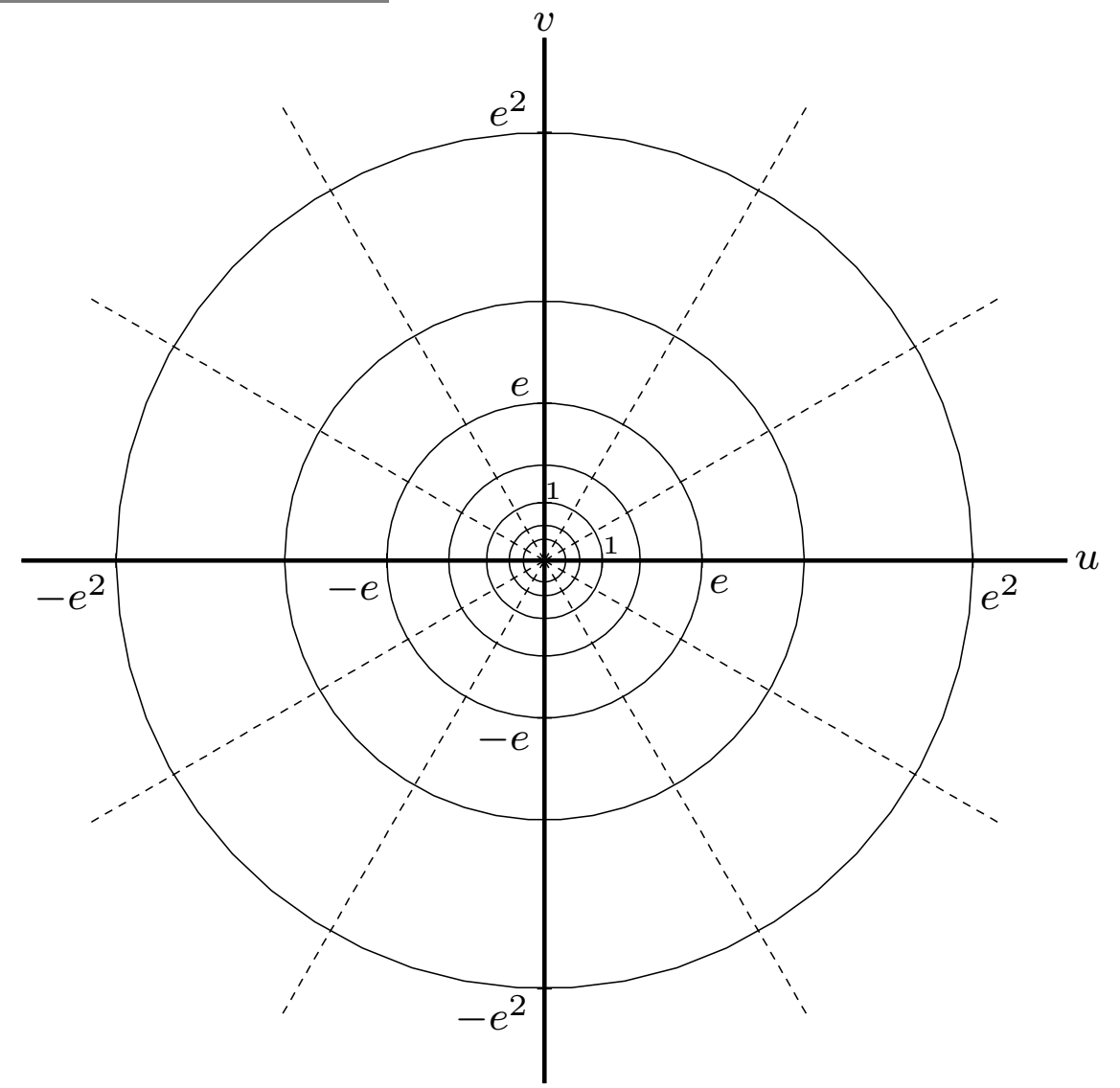
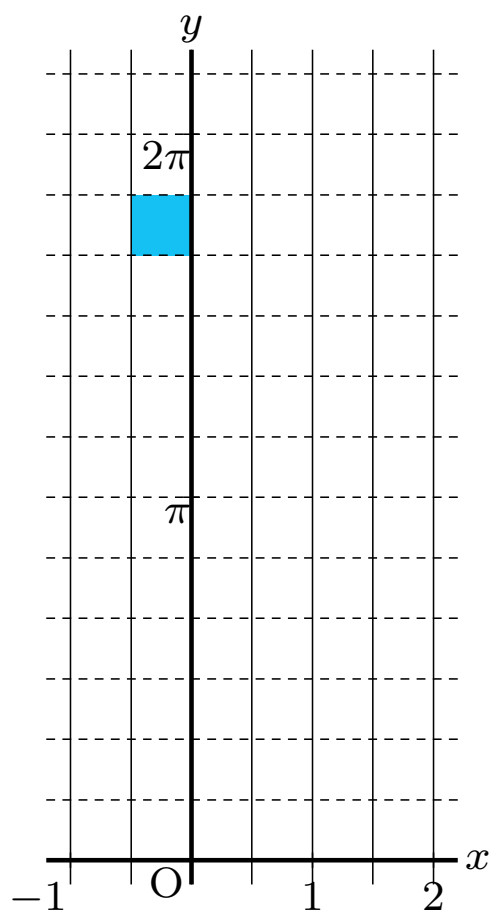

$w = e^z$ z -plane \longrightarrow w -plane

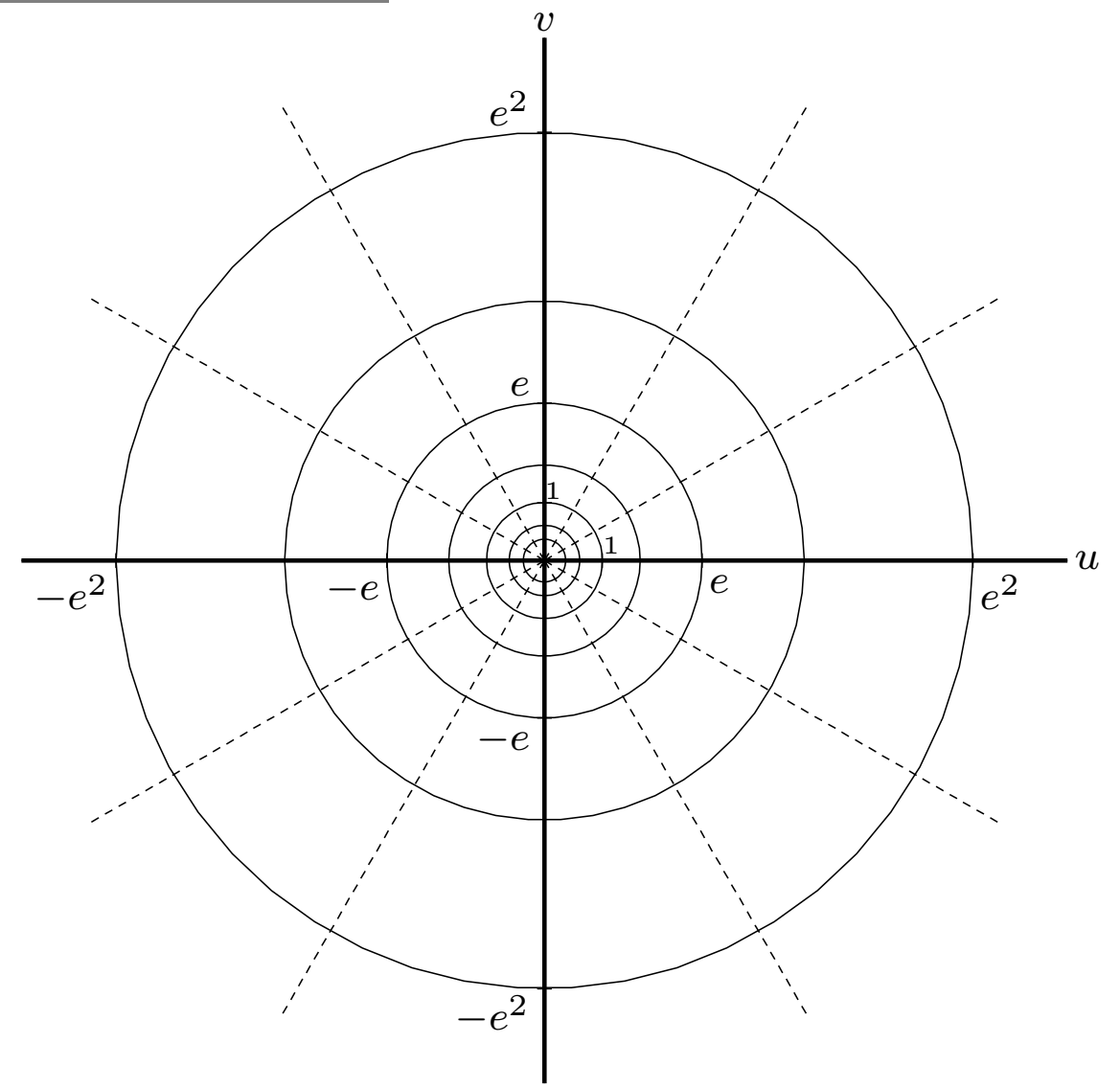
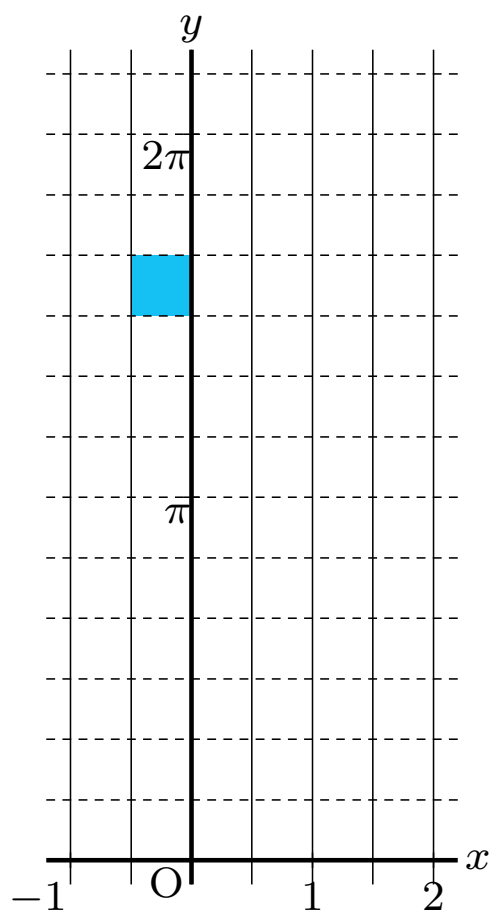

$w = e^z$ z -plane \longrightarrow w -plane

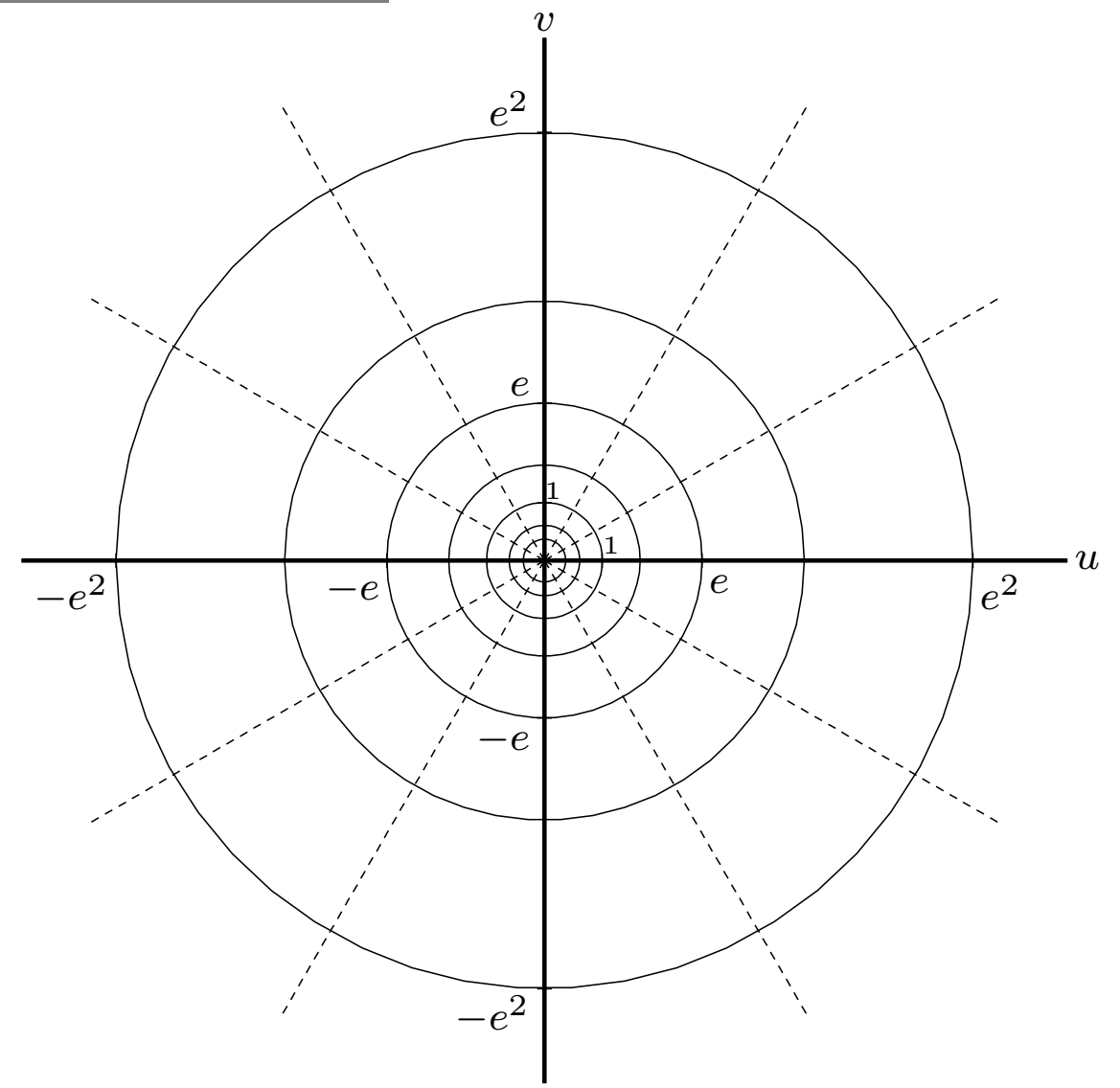
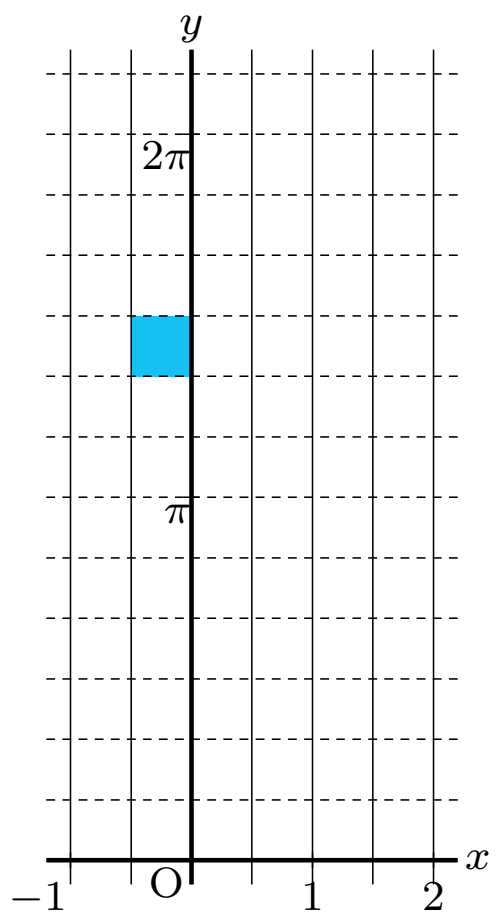

$w = e^z$ z -plane \longrightarrow w -plane

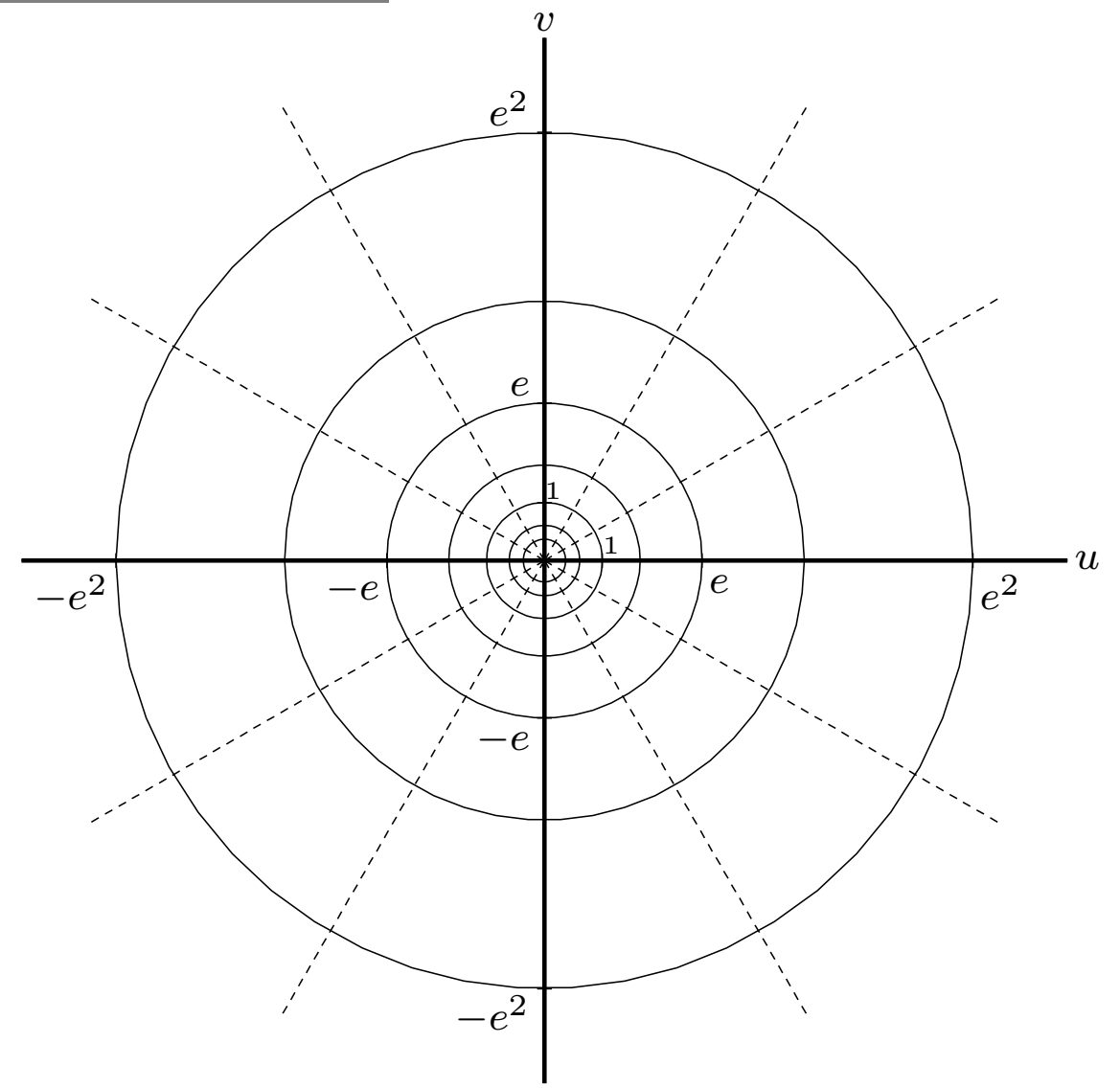
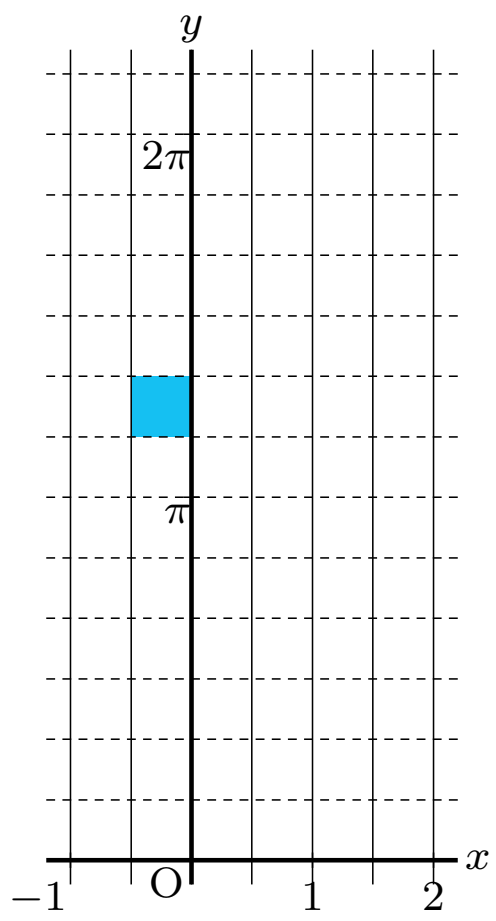

$w = e^z$ z -plane \longrightarrow w -plane

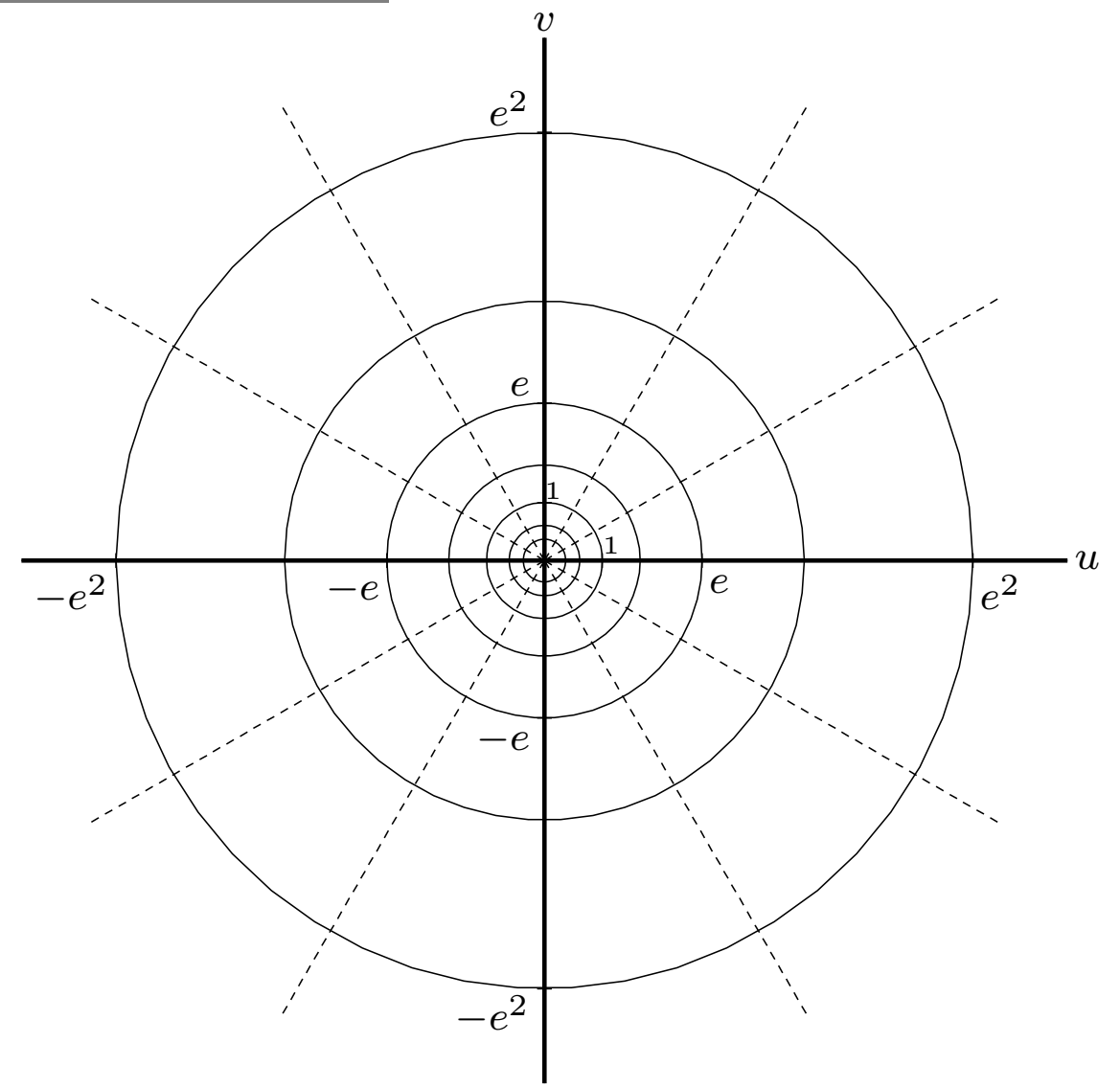
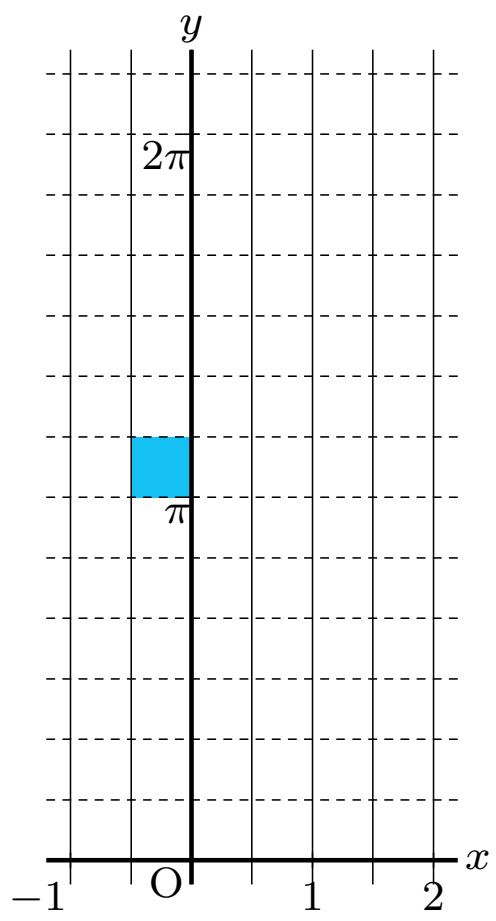

$w = e^z$ z -plane \longrightarrow w -plane

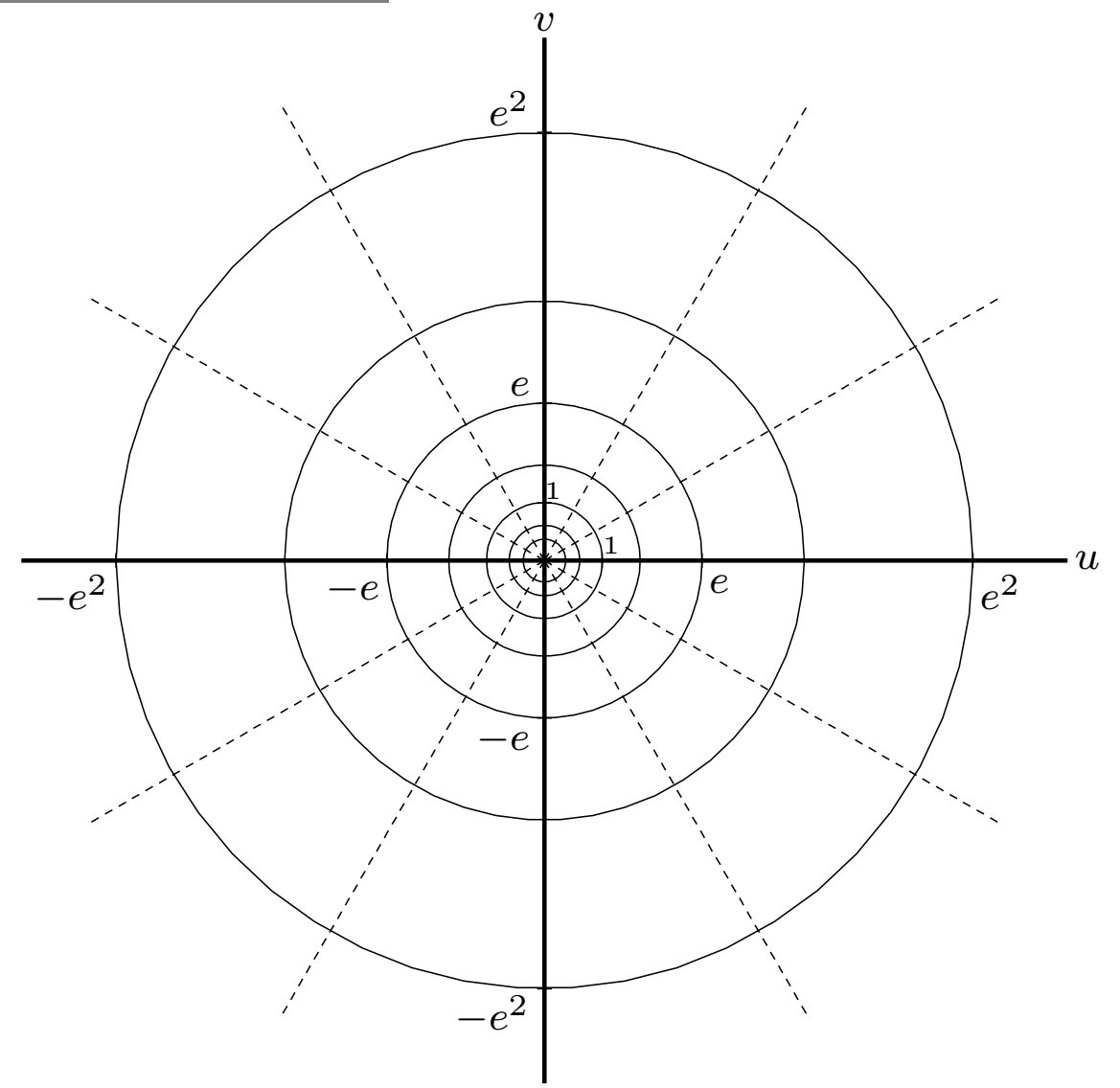
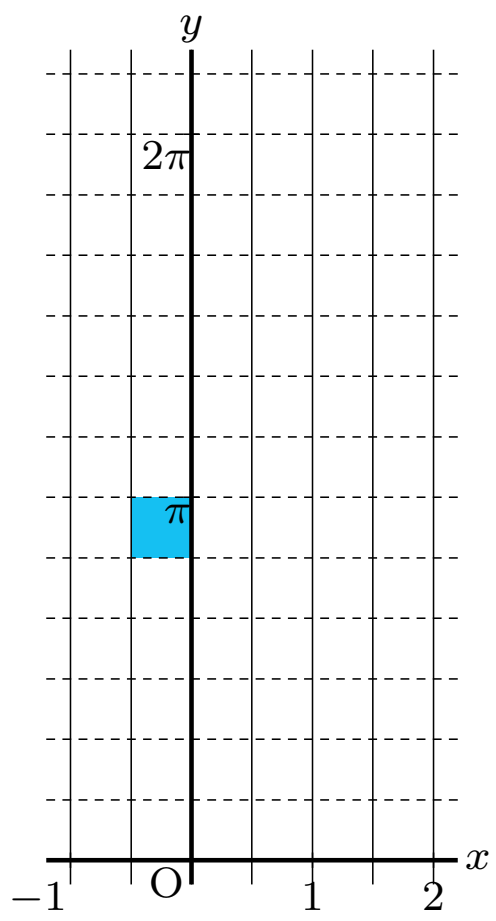

$w = e^z$ z -plane \longrightarrow w -plane

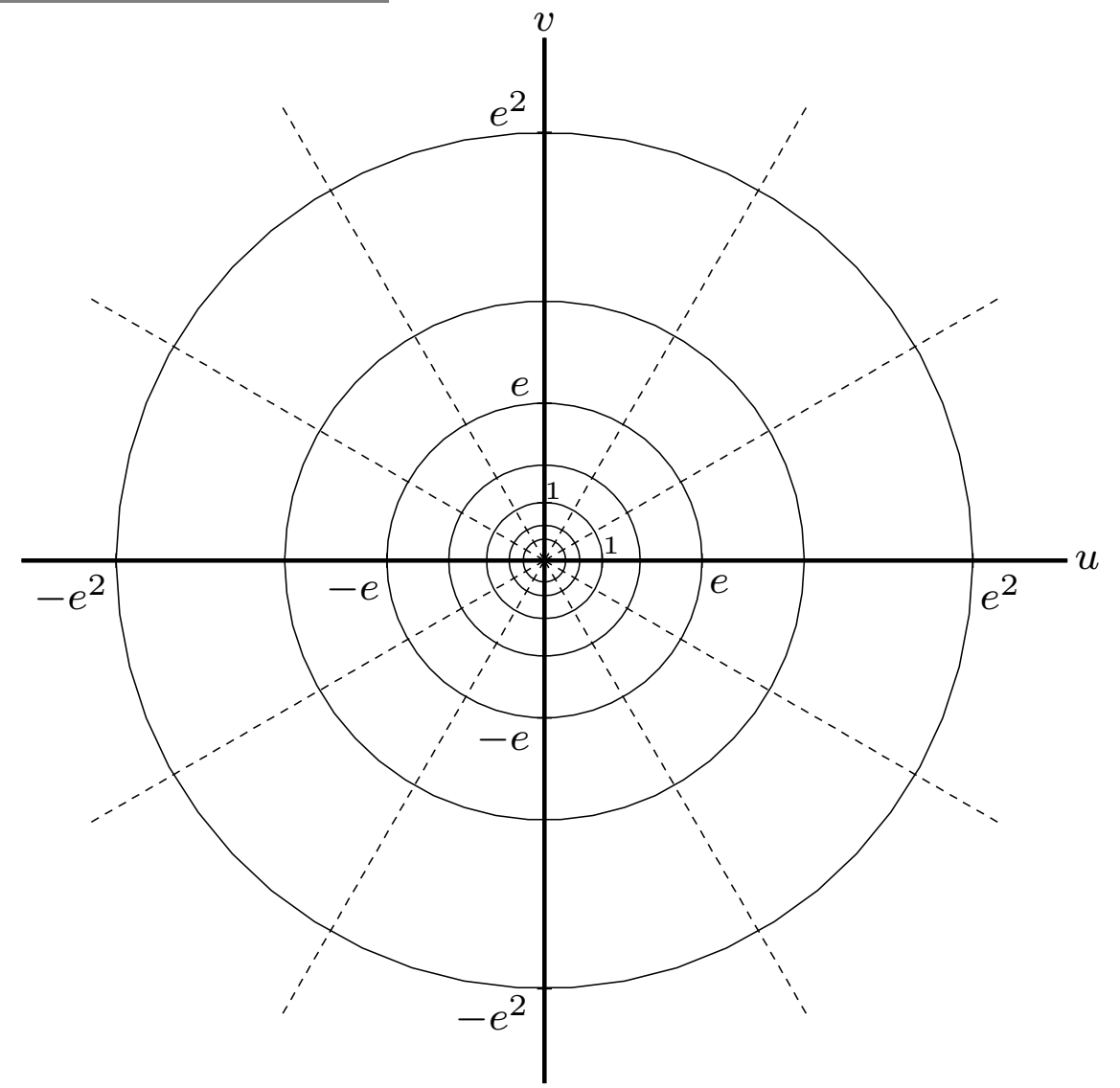
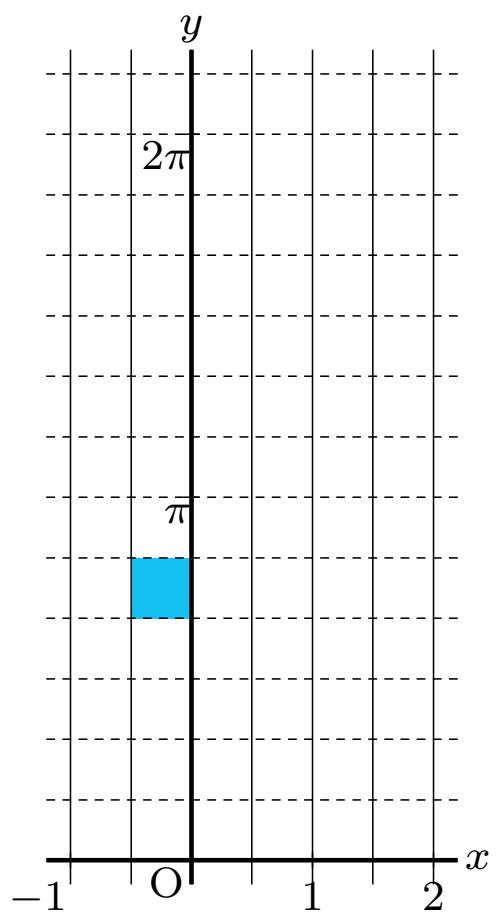

$w = e^z$ z -plane \longrightarrow w -plane

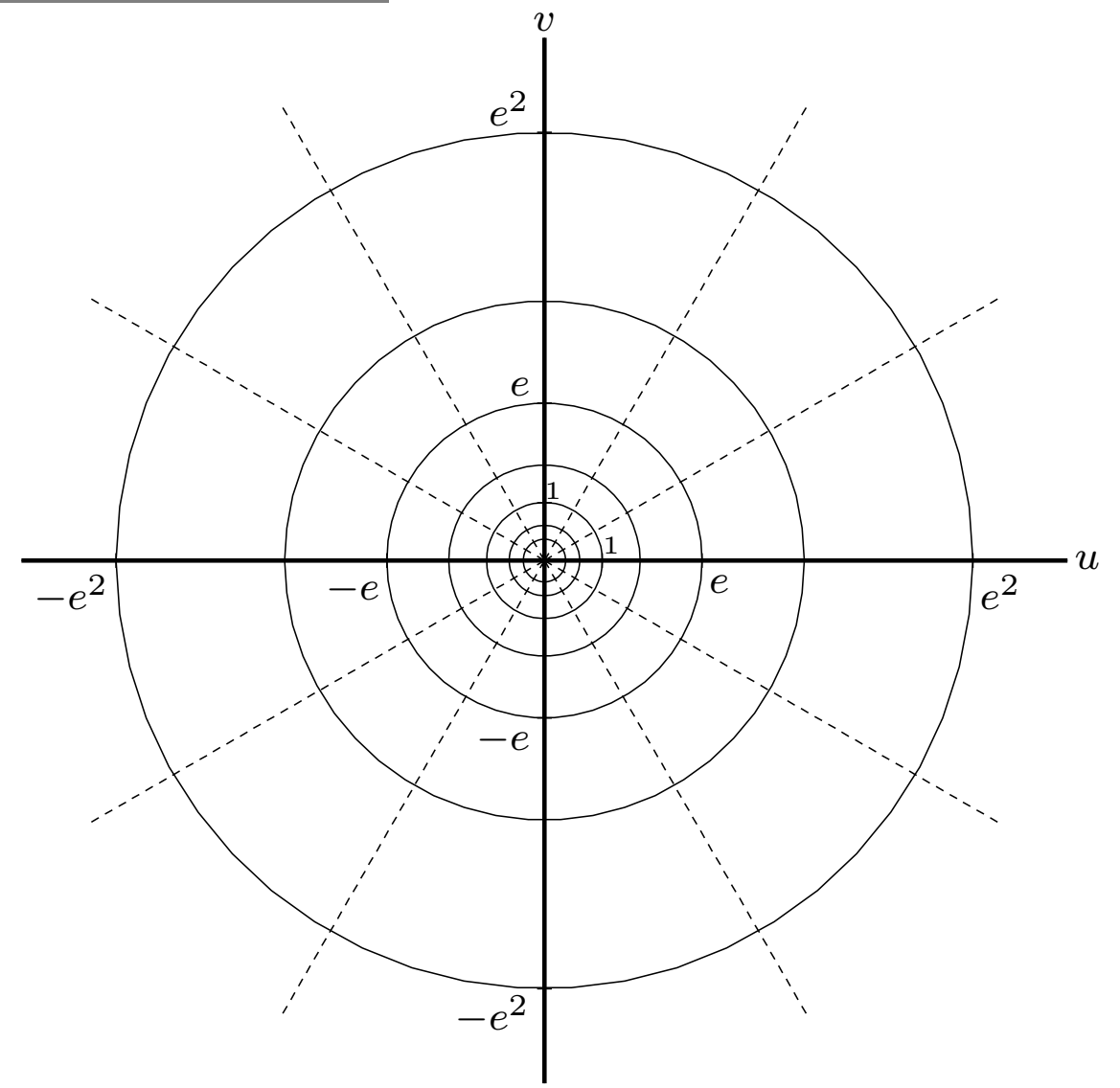
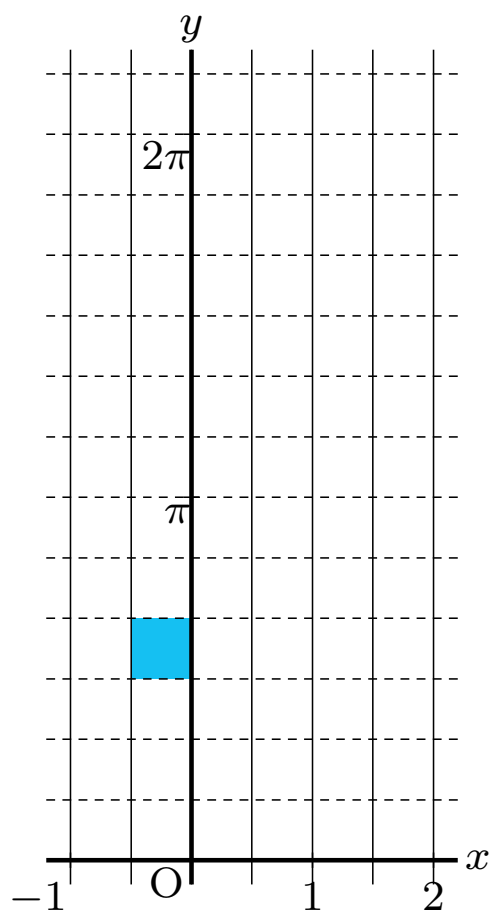

$w = e^z$ z -plane \longrightarrow w -plane

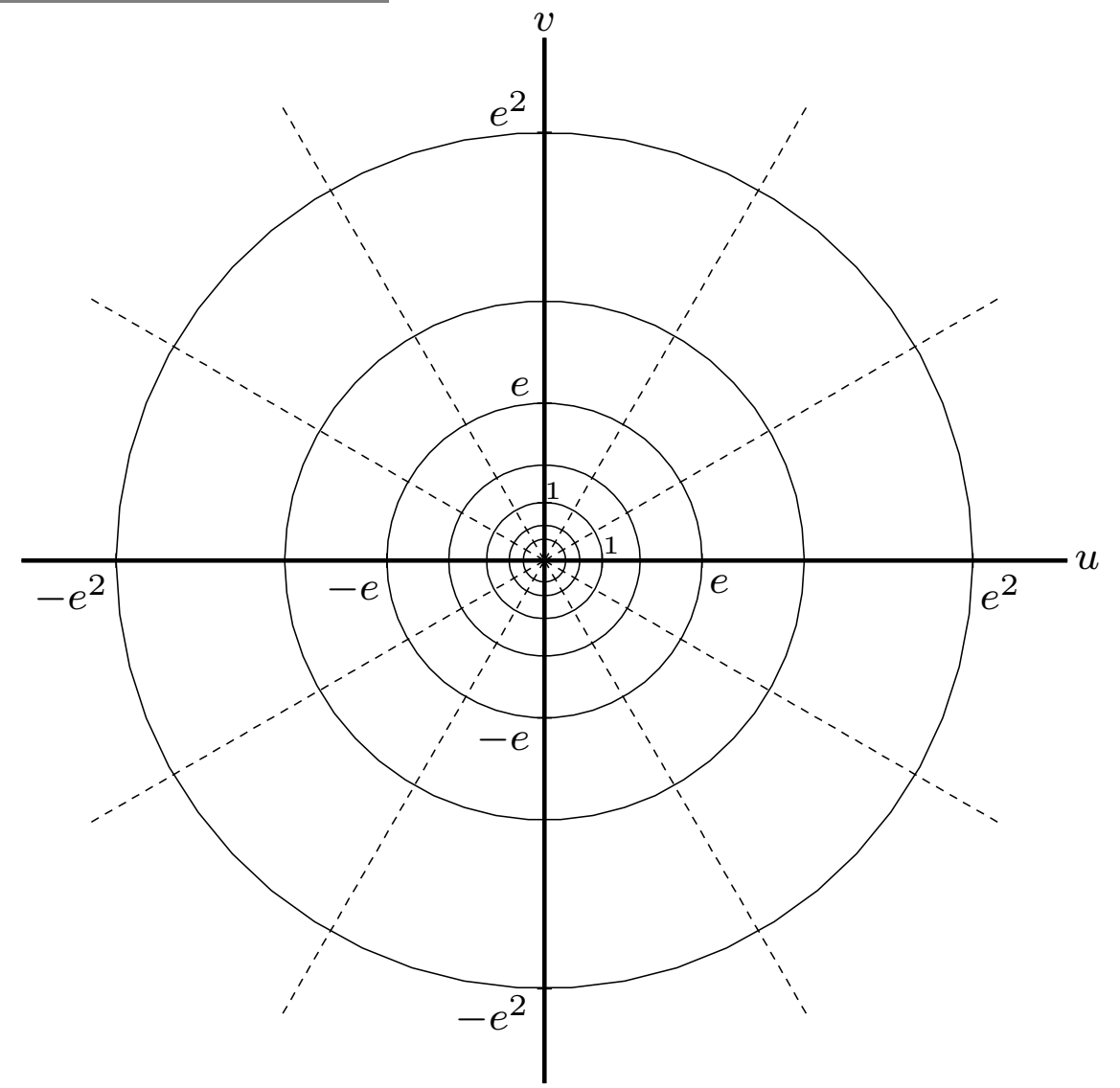
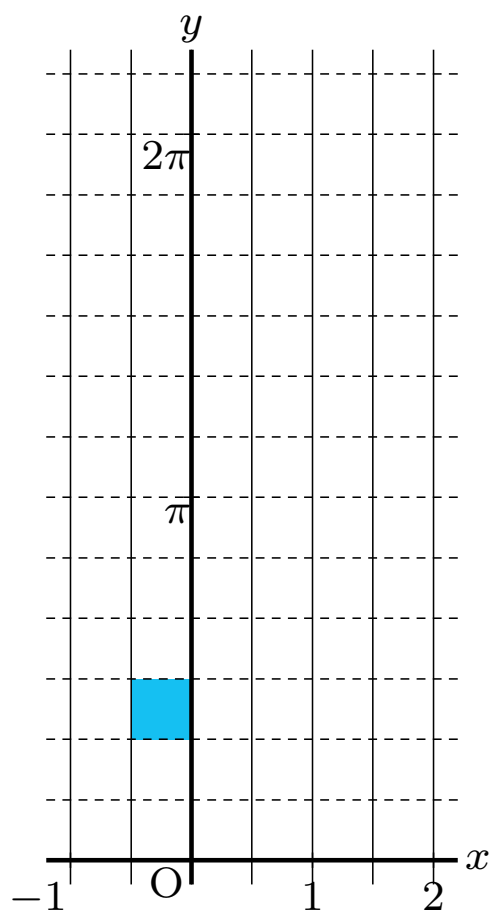

$w = e^z$ z -plane \longrightarrow w -plane

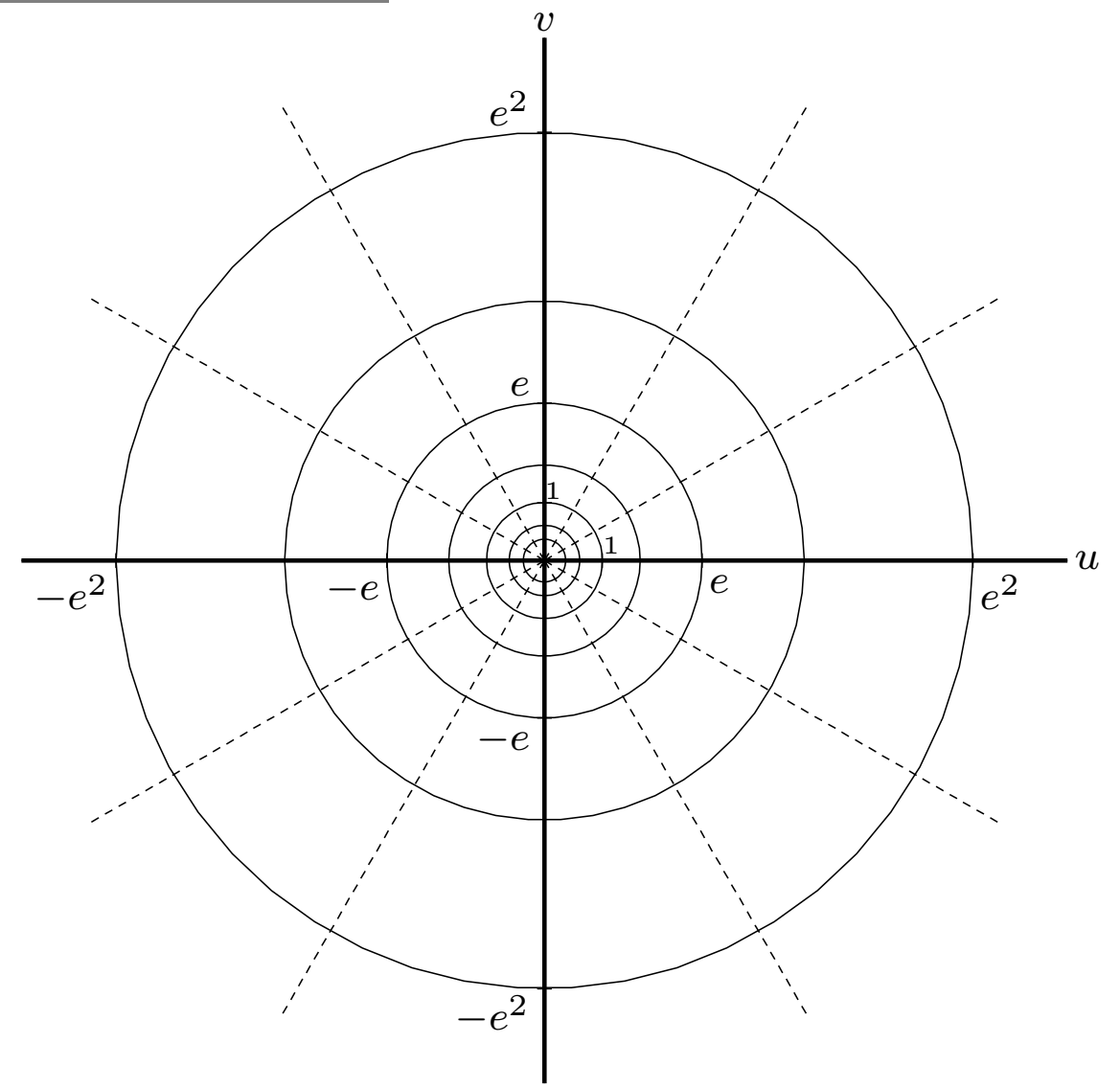
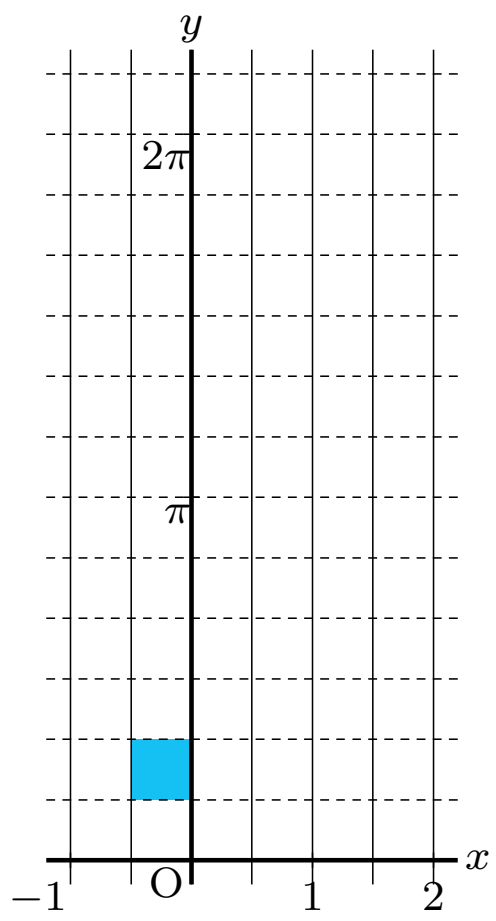

$w = e^z$ z -plane \longrightarrow w -plane

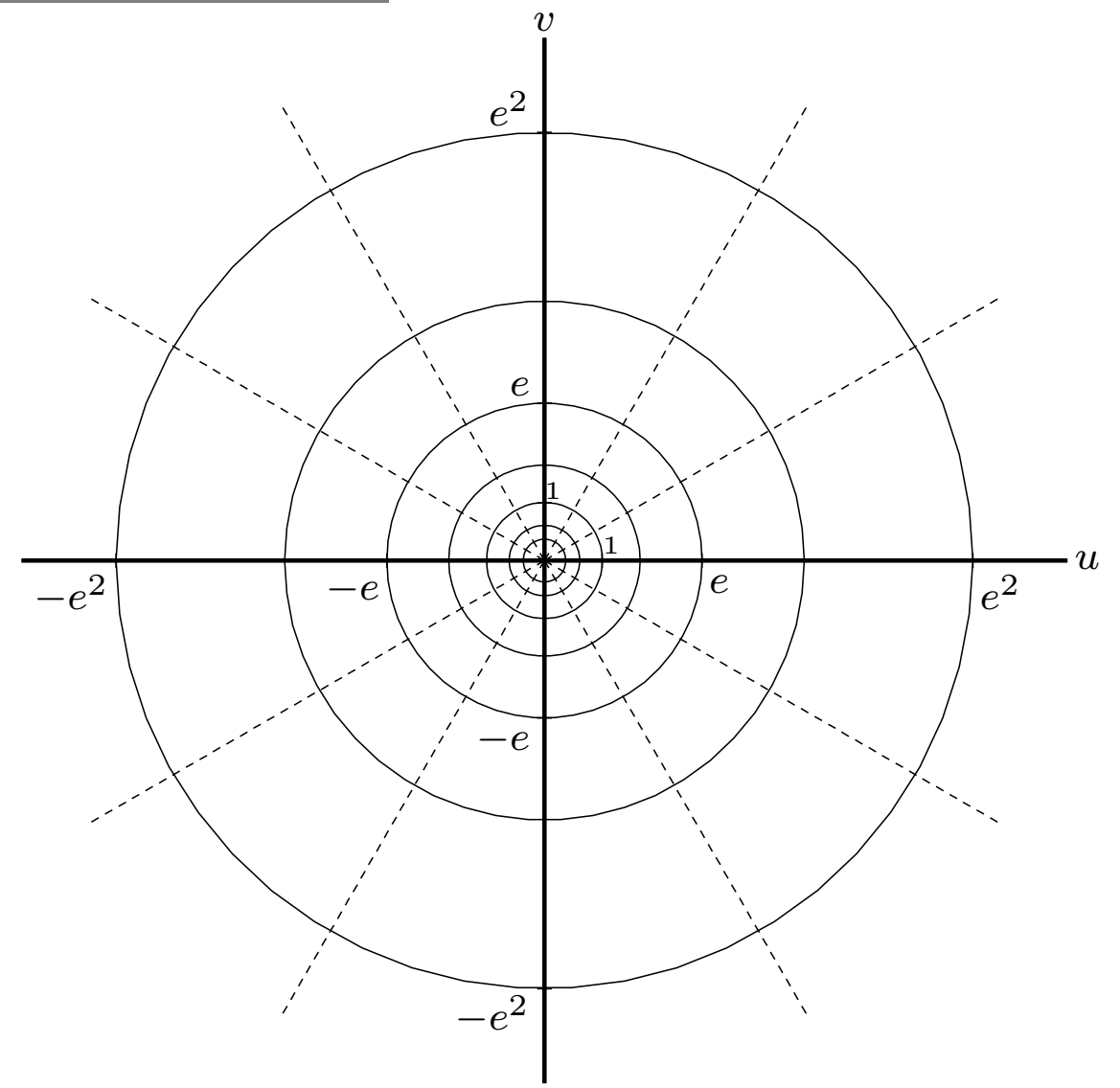
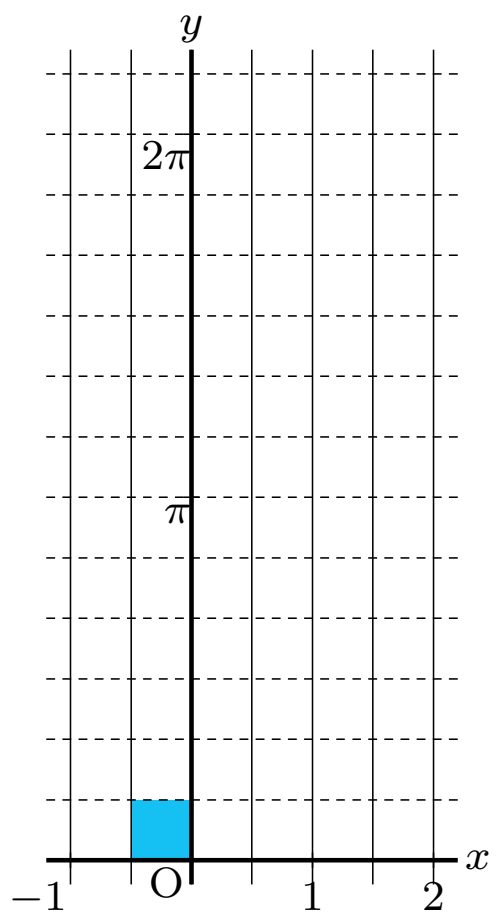

$w = e^z$ z -plane \longrightarrow w -plane

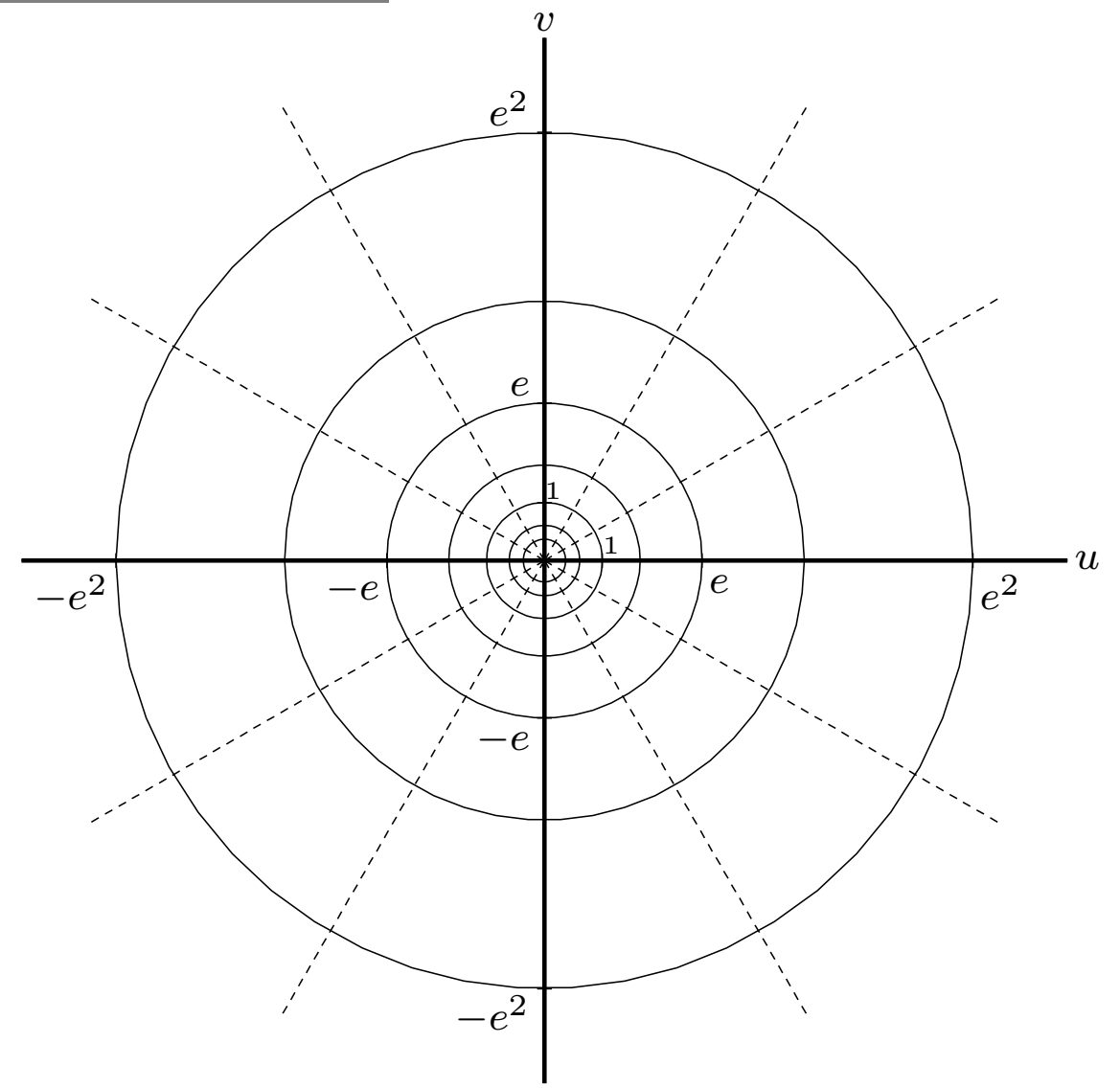
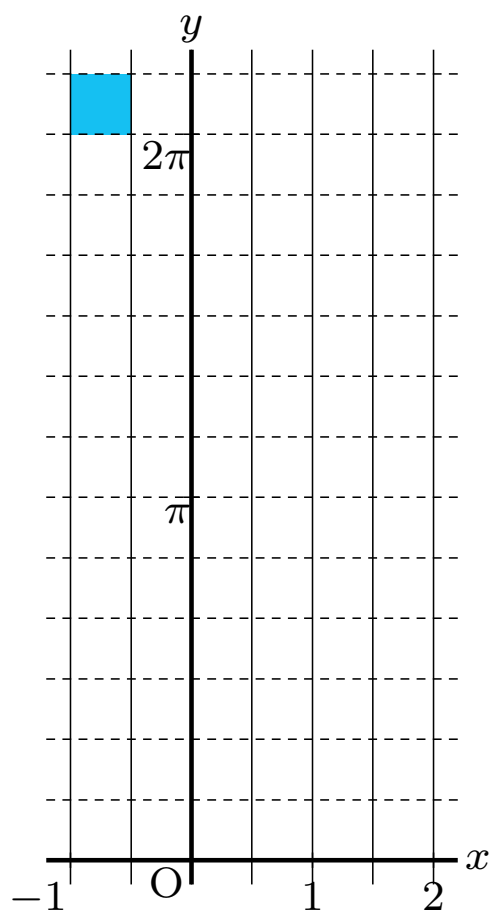

$w = e^z$ z -plane \longrightarrow w -plane

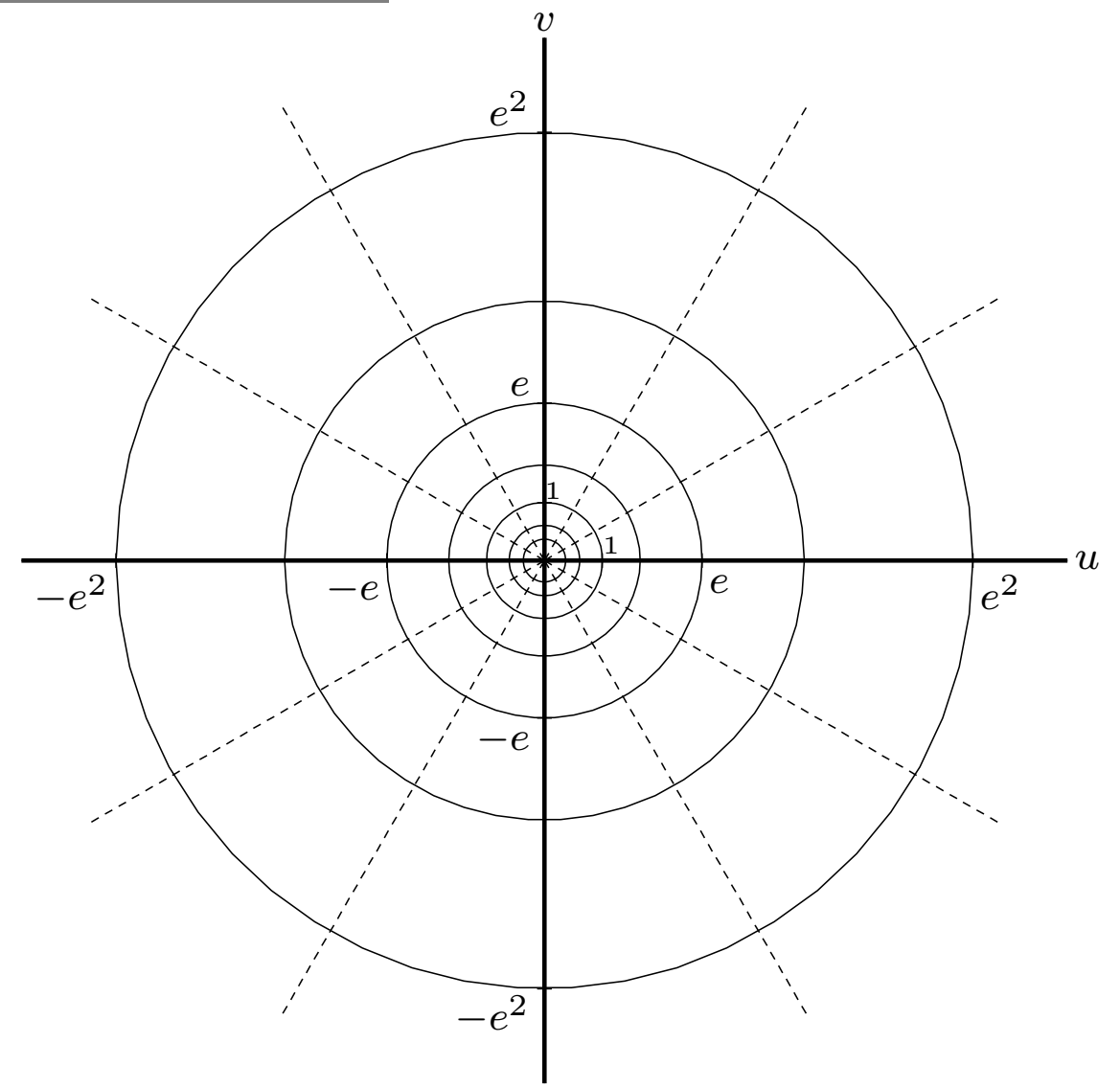
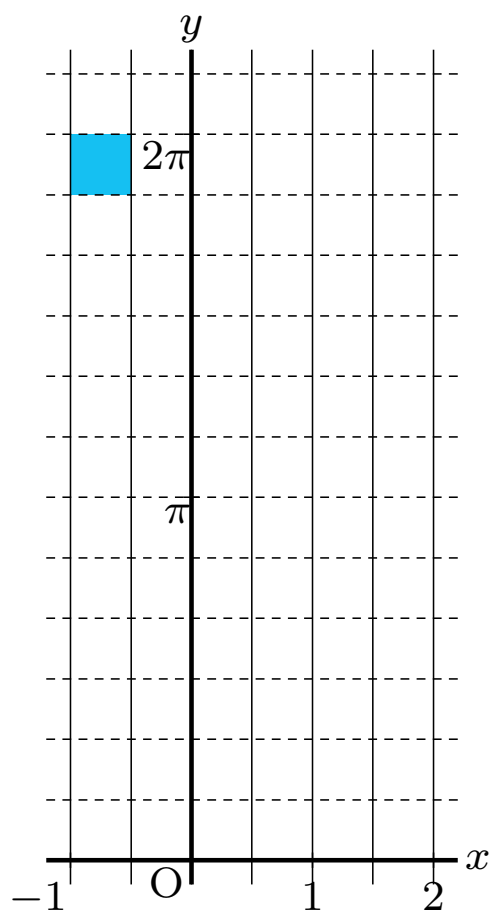

$w = e^z$ z -plane \longrightarrow w -plane

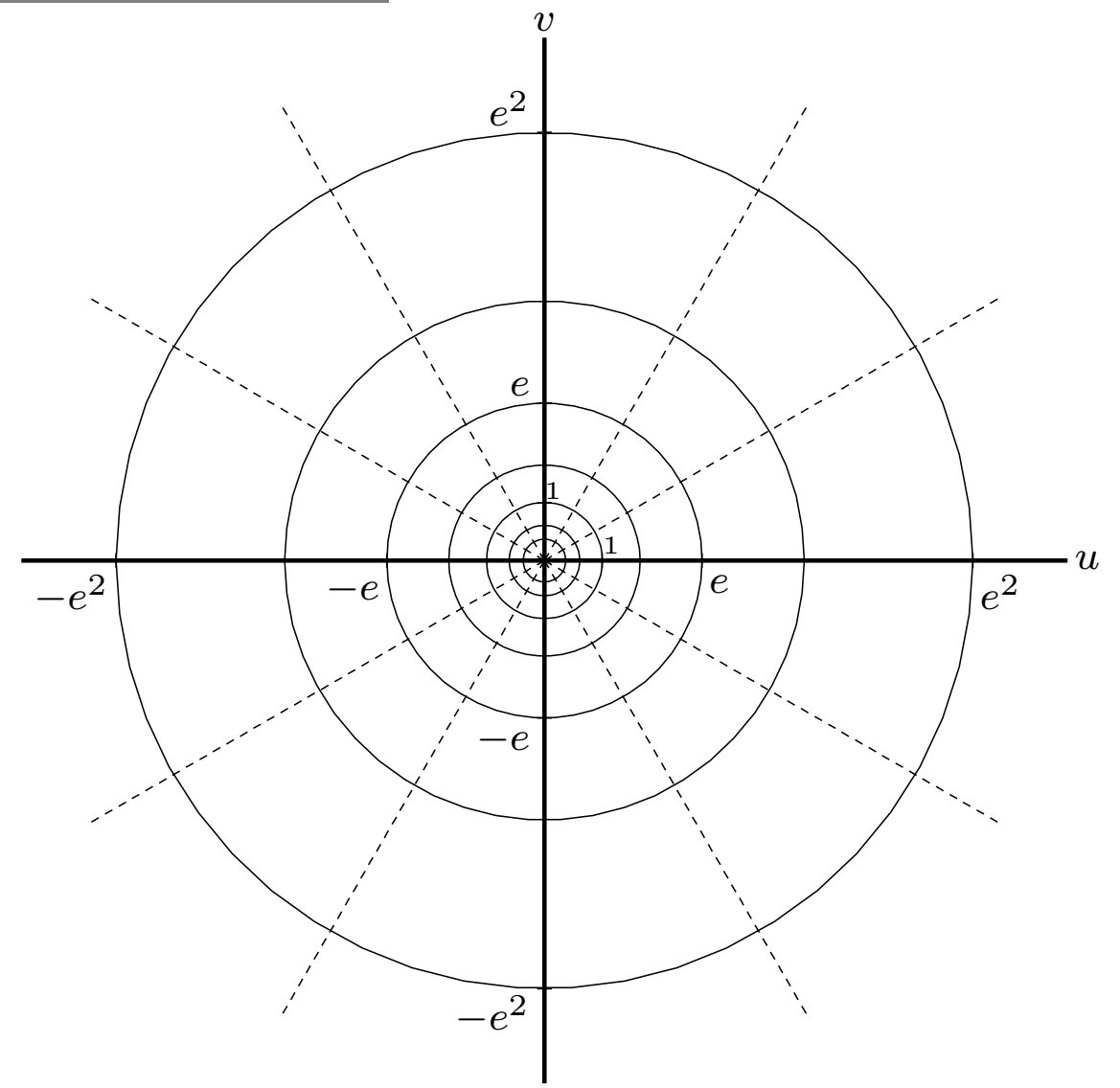
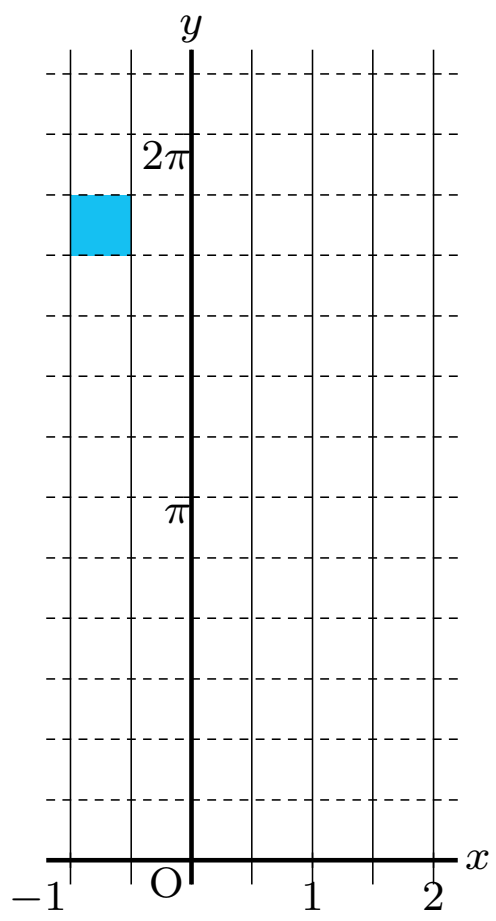

$w = e^z$ z -plane \longrightarrow w -plane

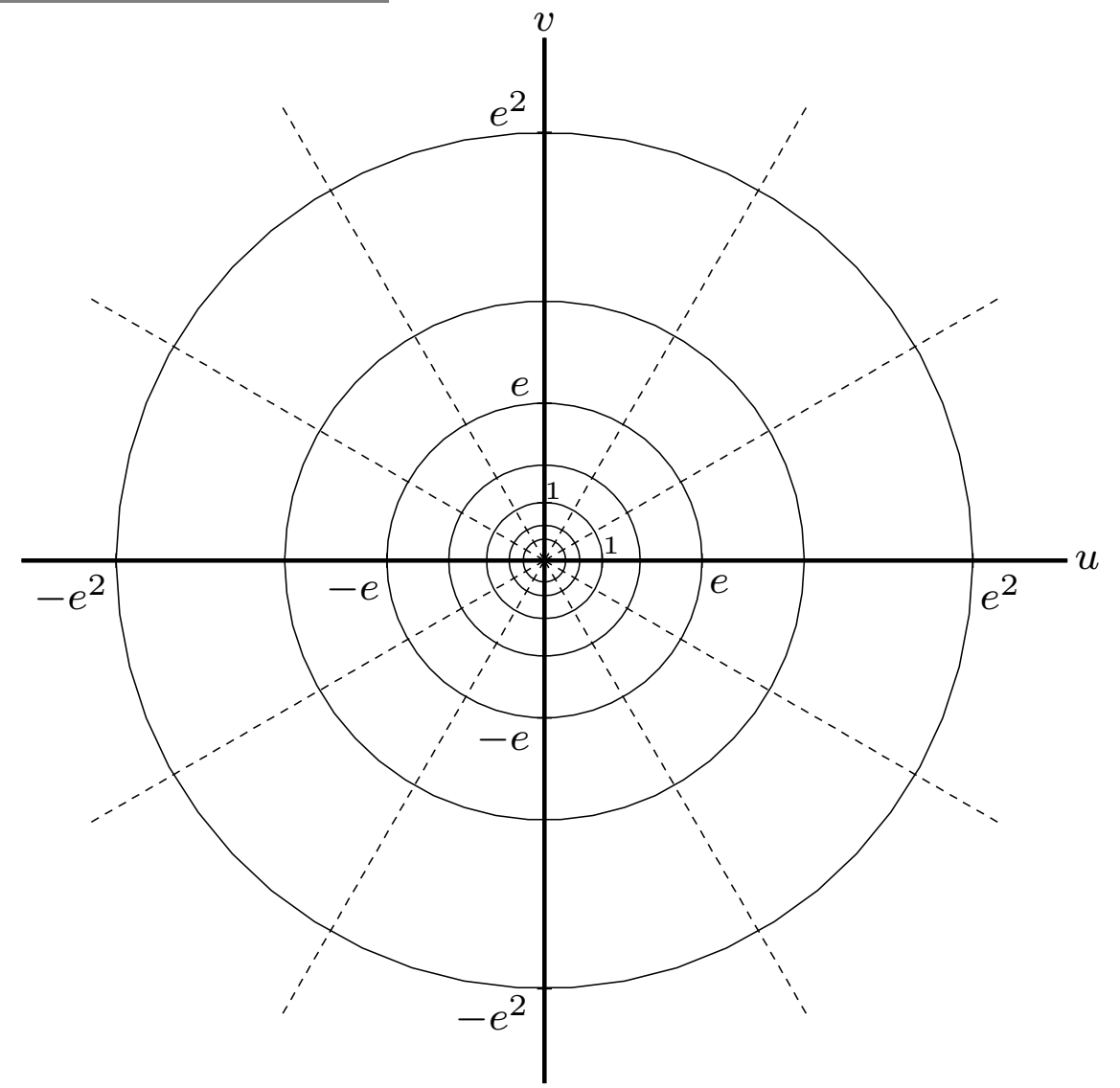
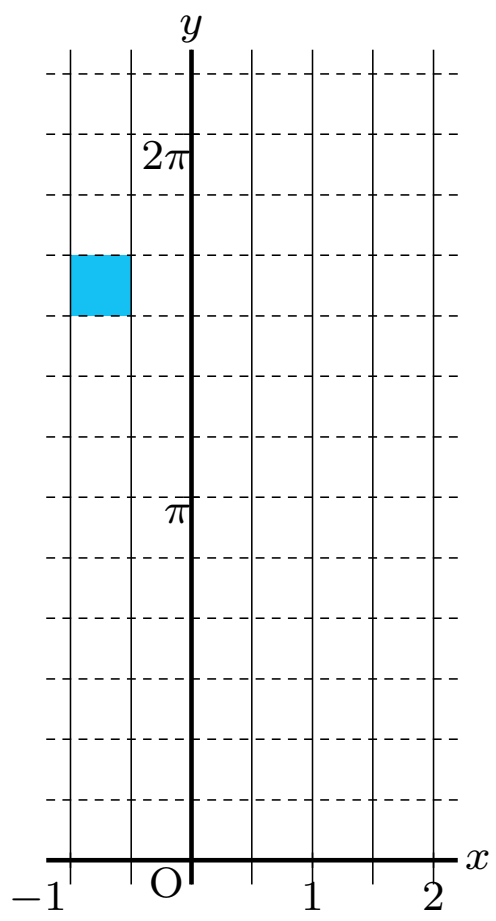

$w = e^z$ z -plane \longrightarrow w -plane

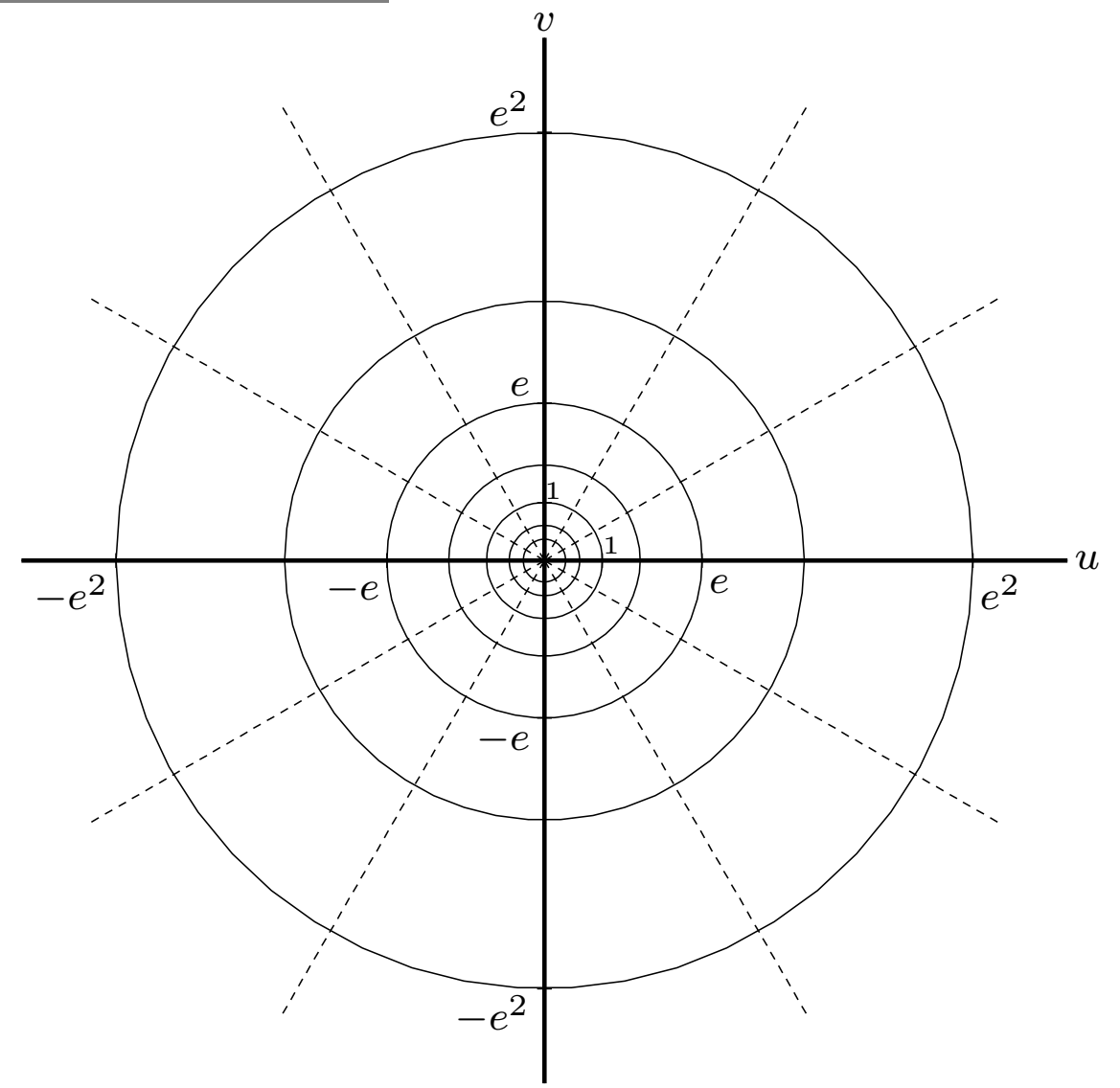
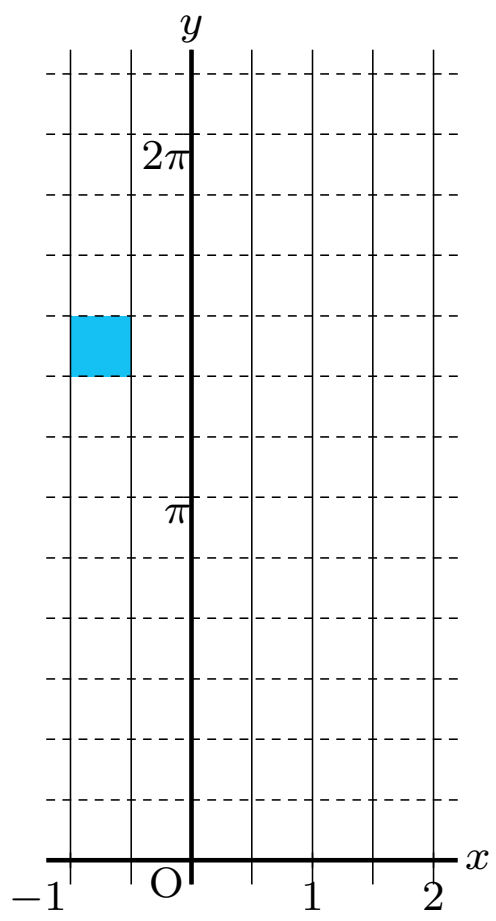

$w = e^z$ z -plane \longrightarrow w -plane

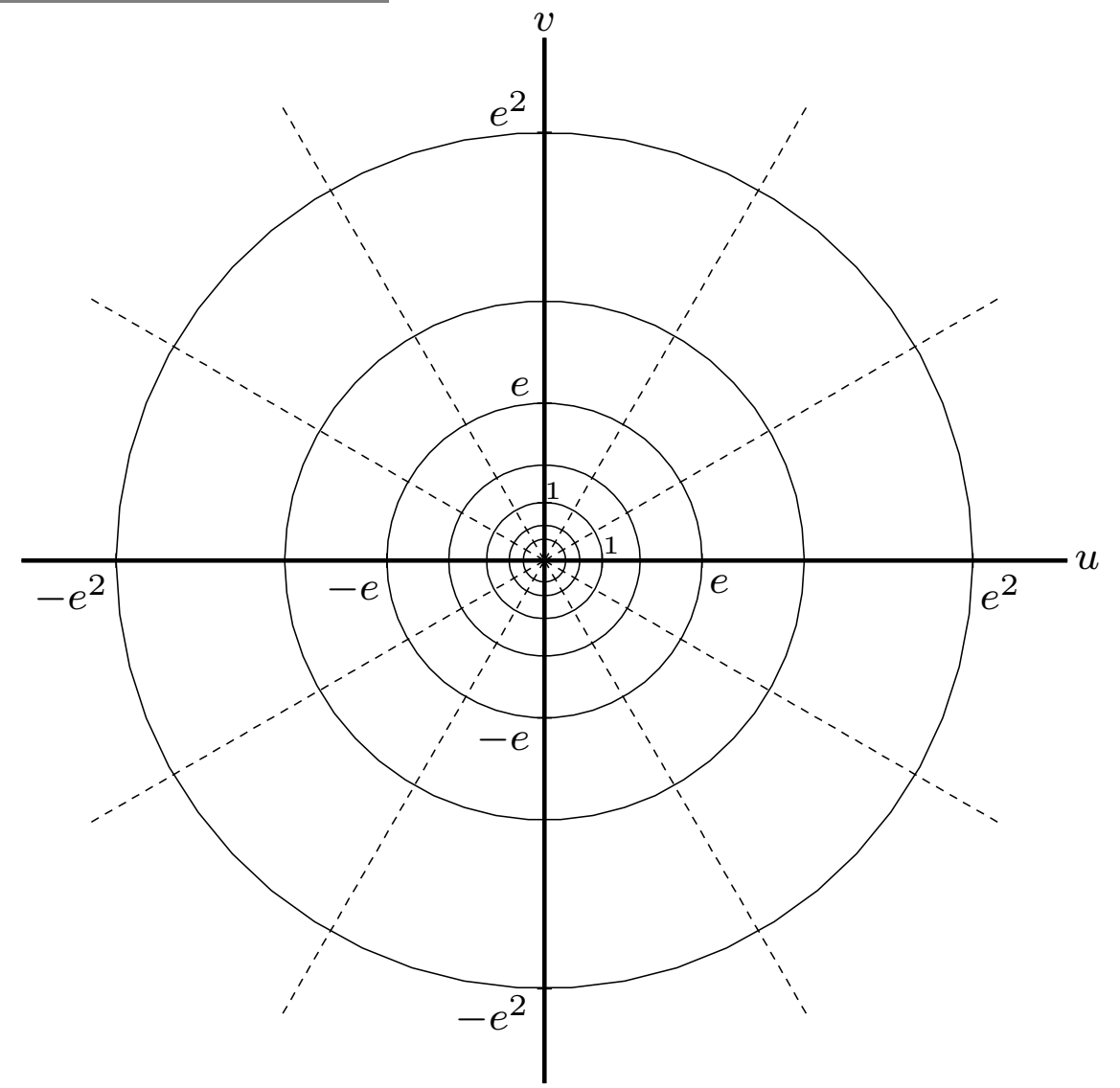
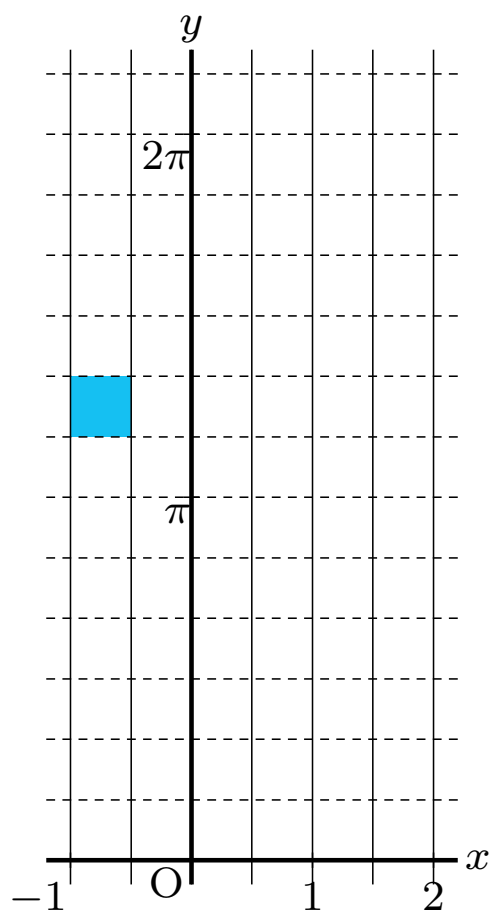

$w = e^z$ z -plane \longrightarrow w -plane

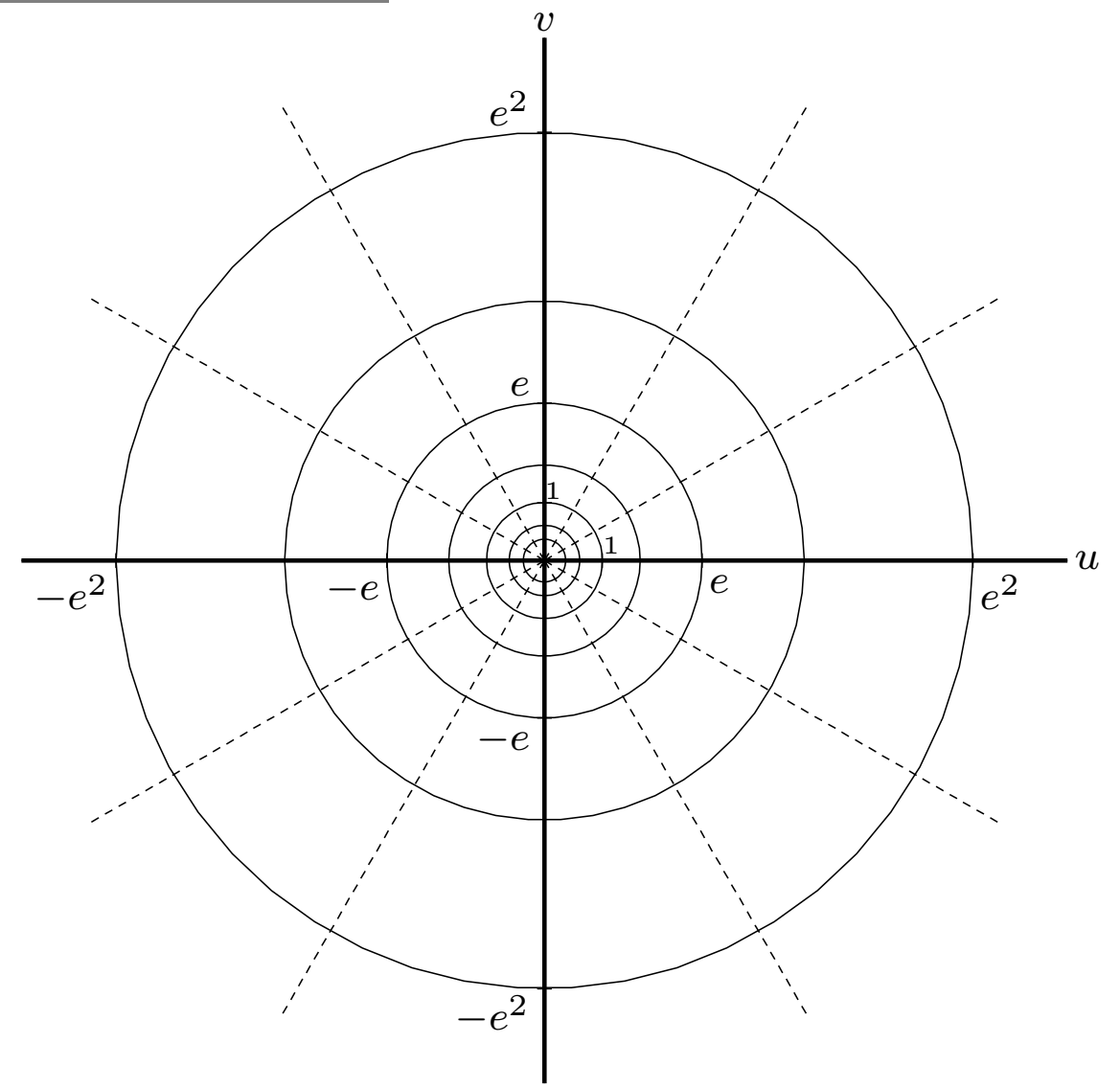
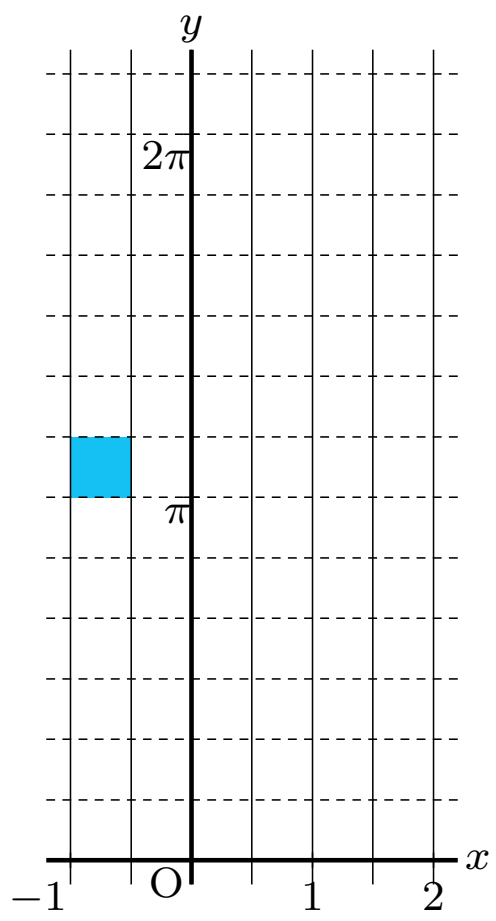

$w = e^z$ z -plane \longrightarrow w -plane

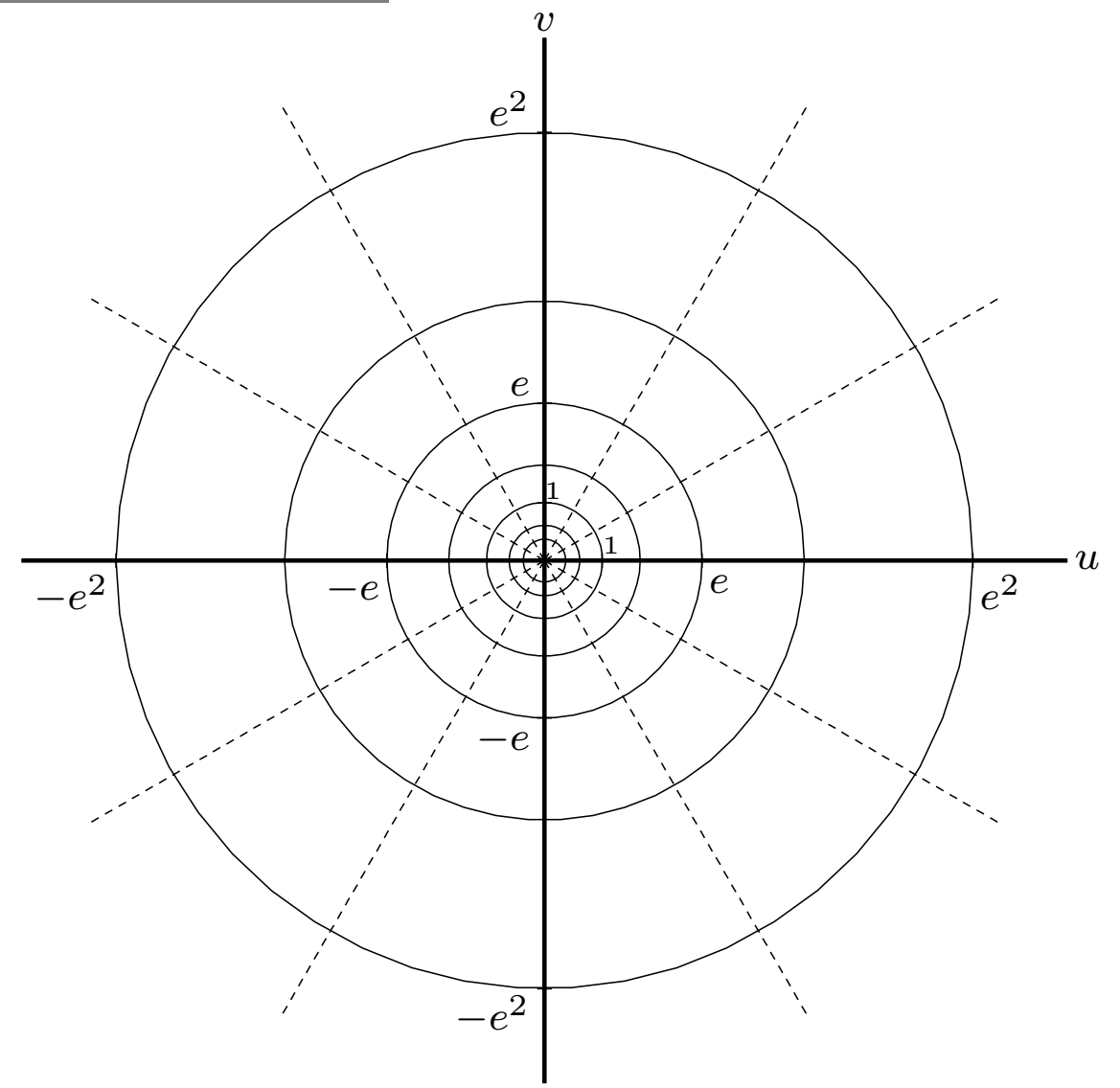
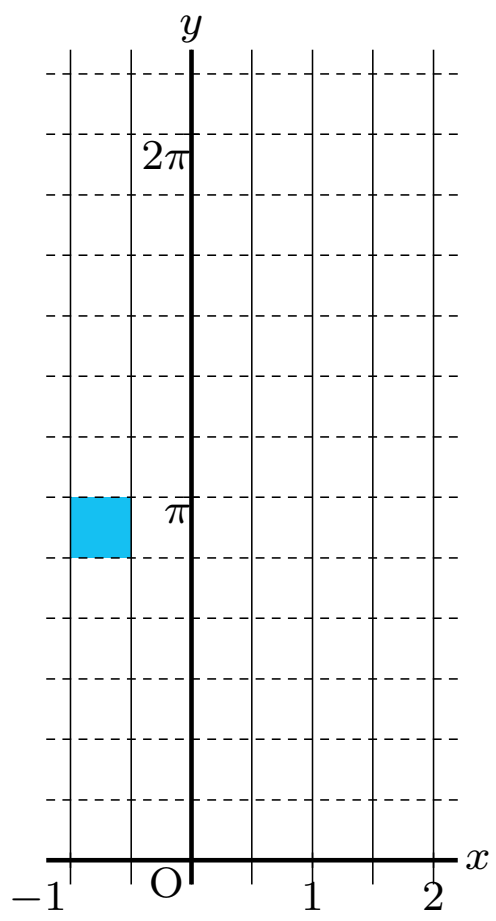

$w = e^z$ z -plane \longrightarrow w -plane

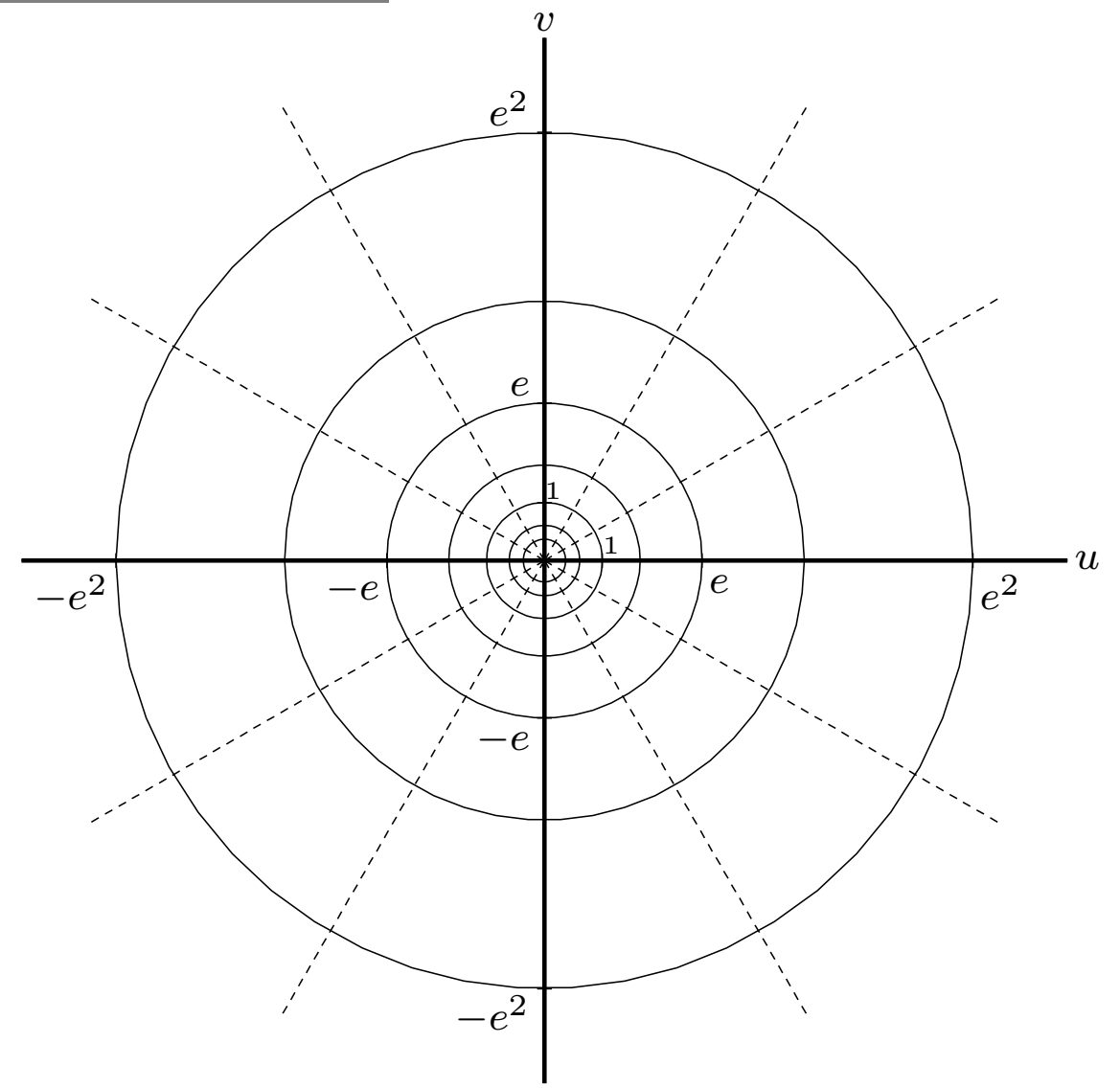
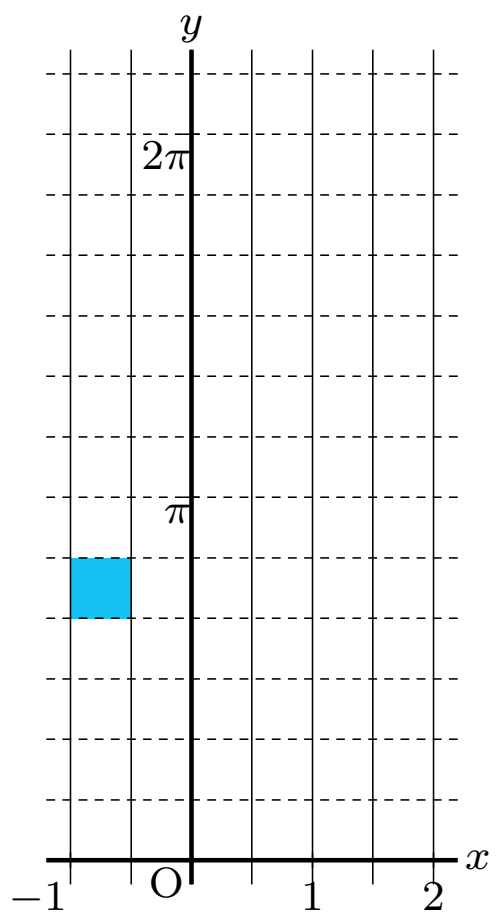

$w = e^z$ z -plane \longrightarrow w -plane

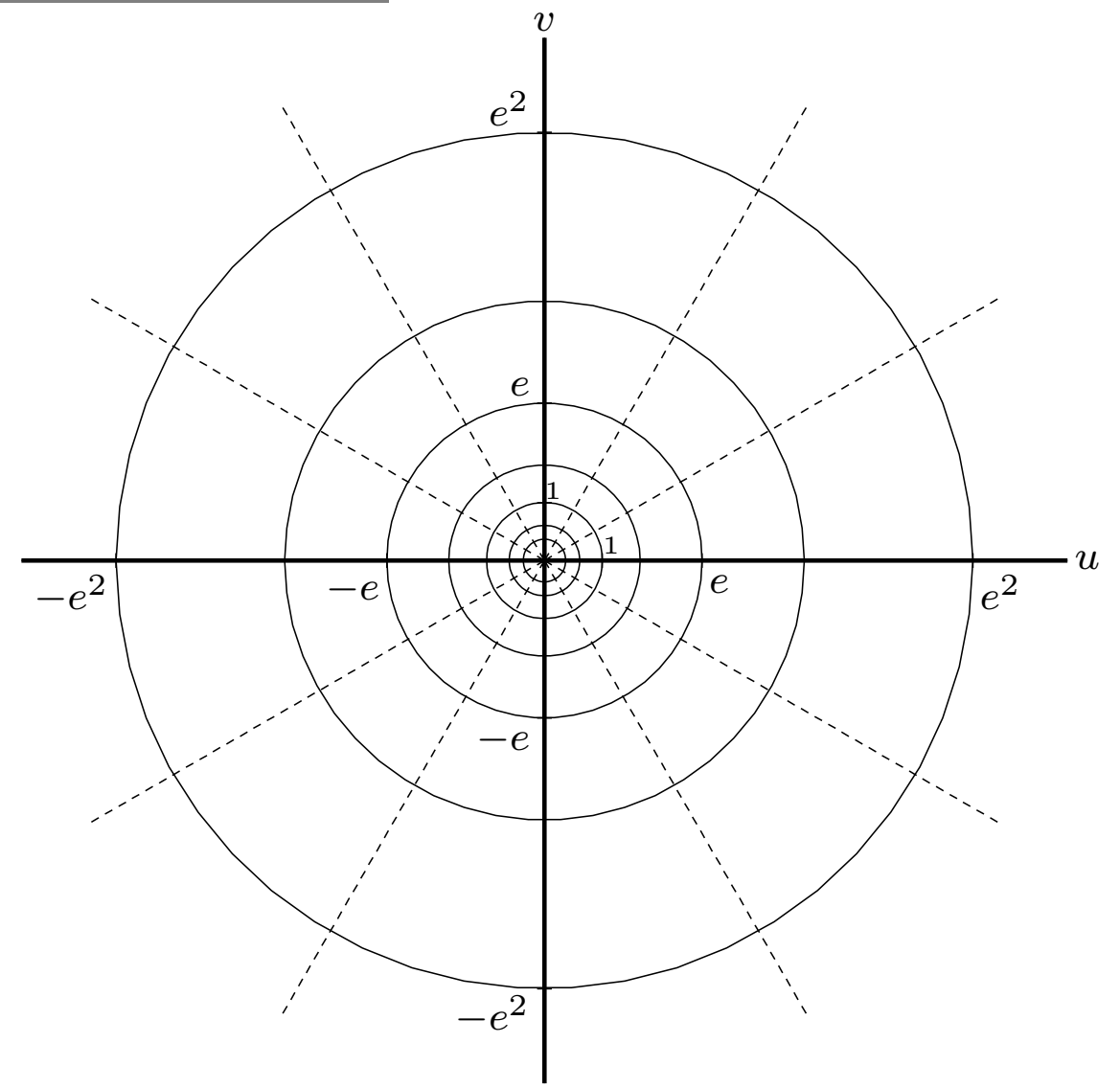
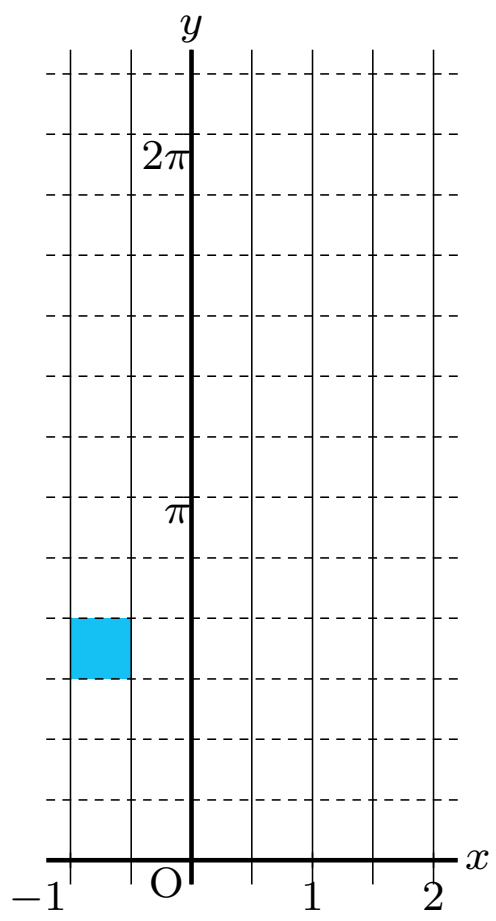

$w = e^z$ z -plane \longrightarrow w -plane

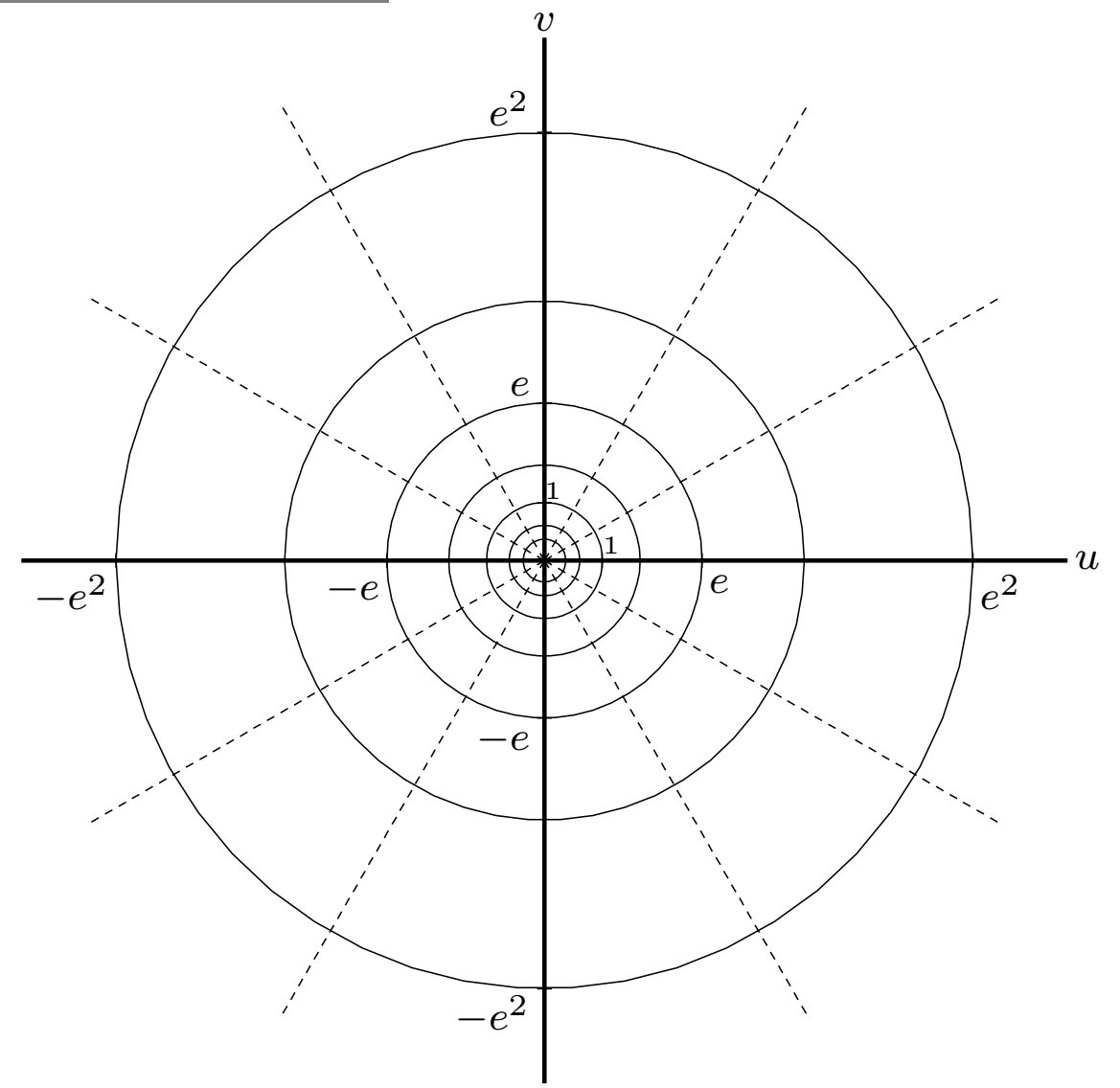
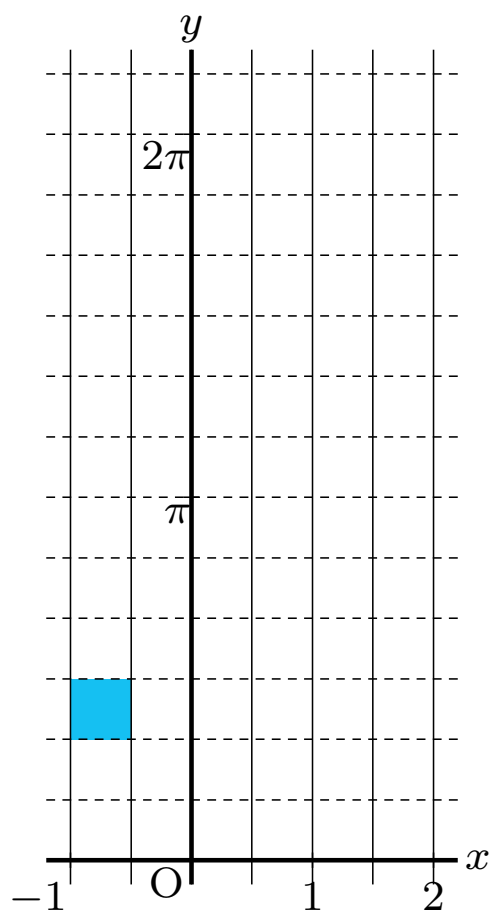

$w = e^z$ z -plane \longrightarrow w -plane

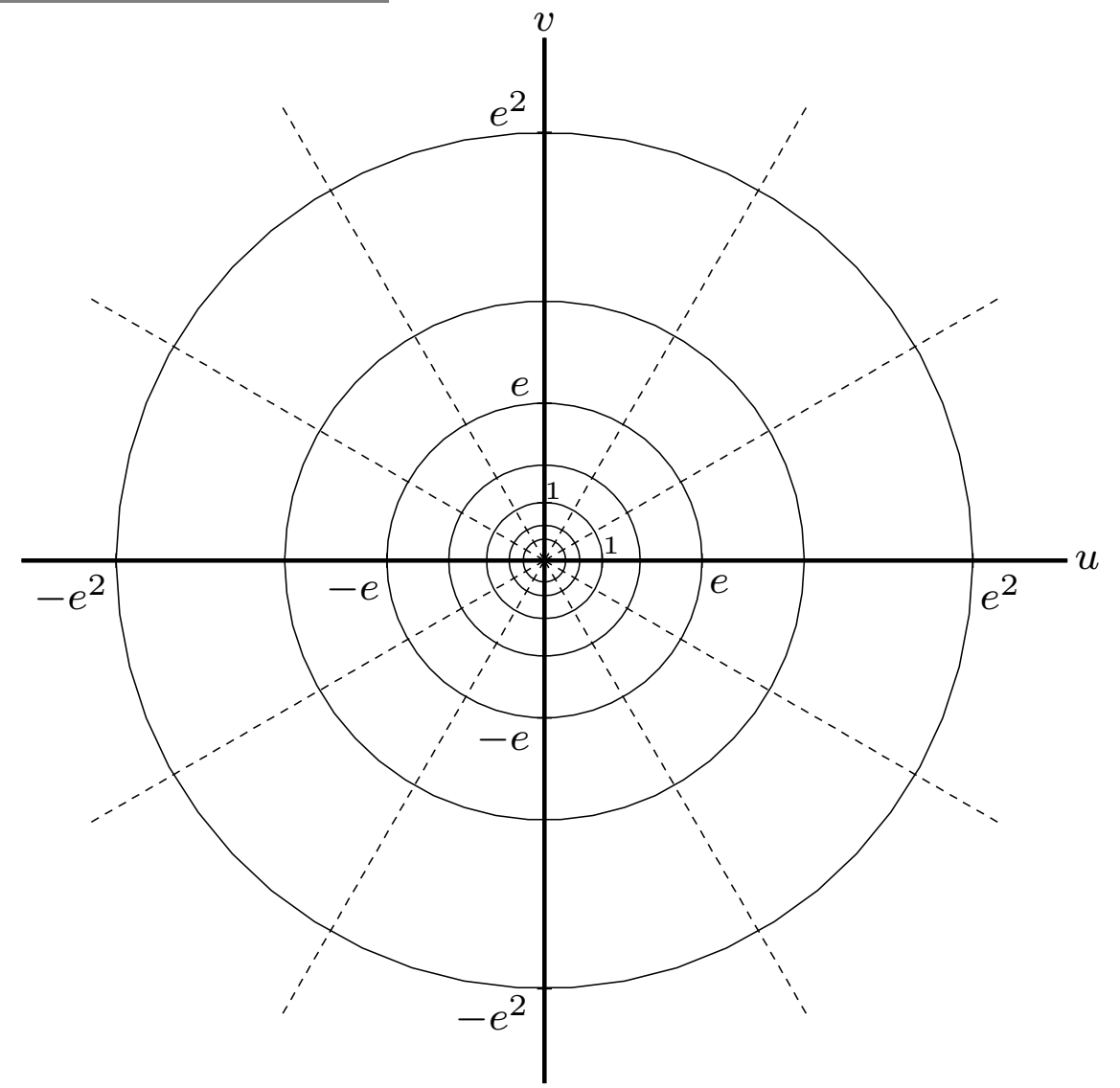
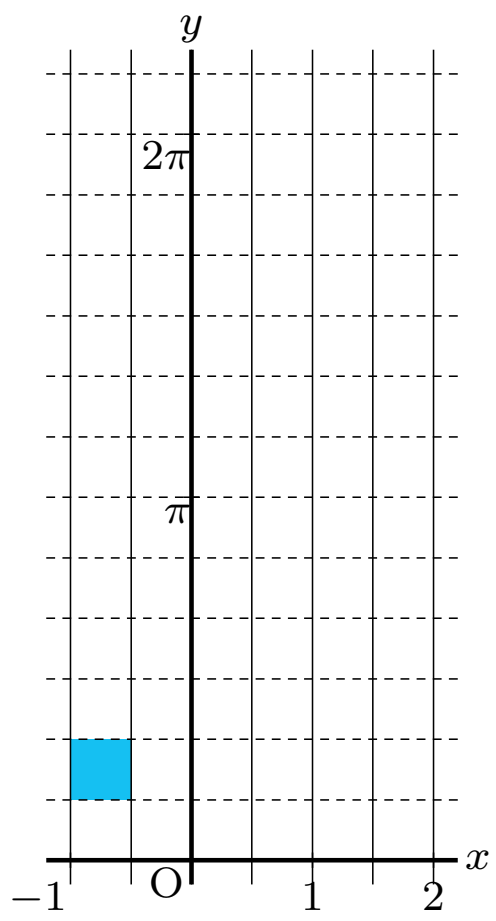

$w = e^z$ z -plane \longrightarrow w -plane

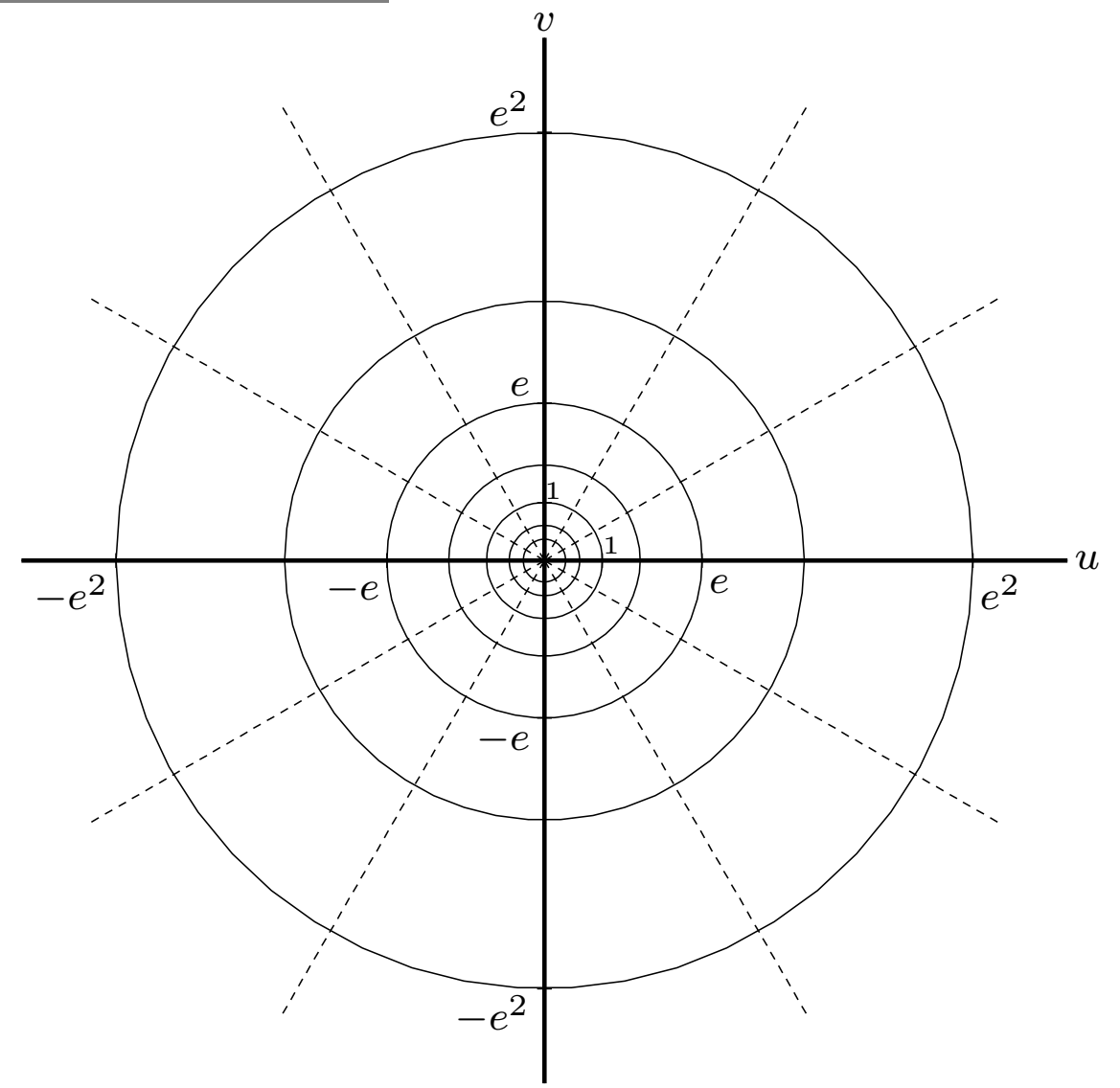
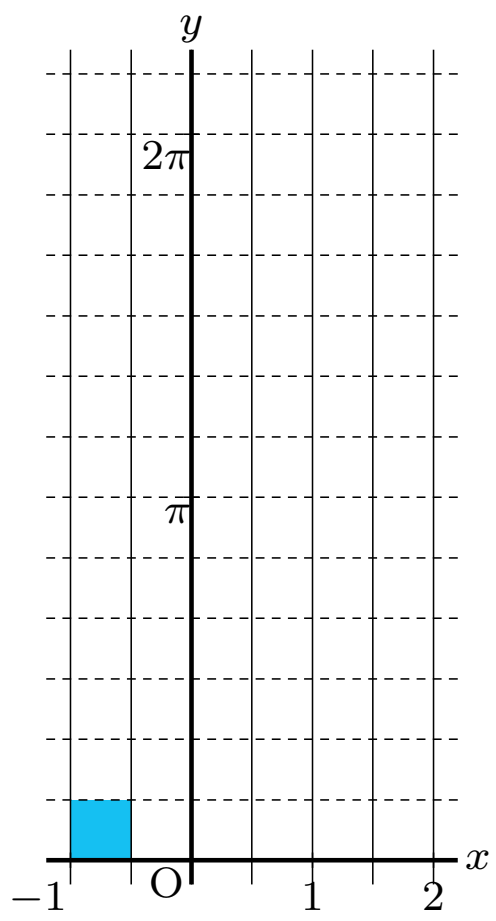

$w = e^z$ z -plane \longrightarrow w -plane

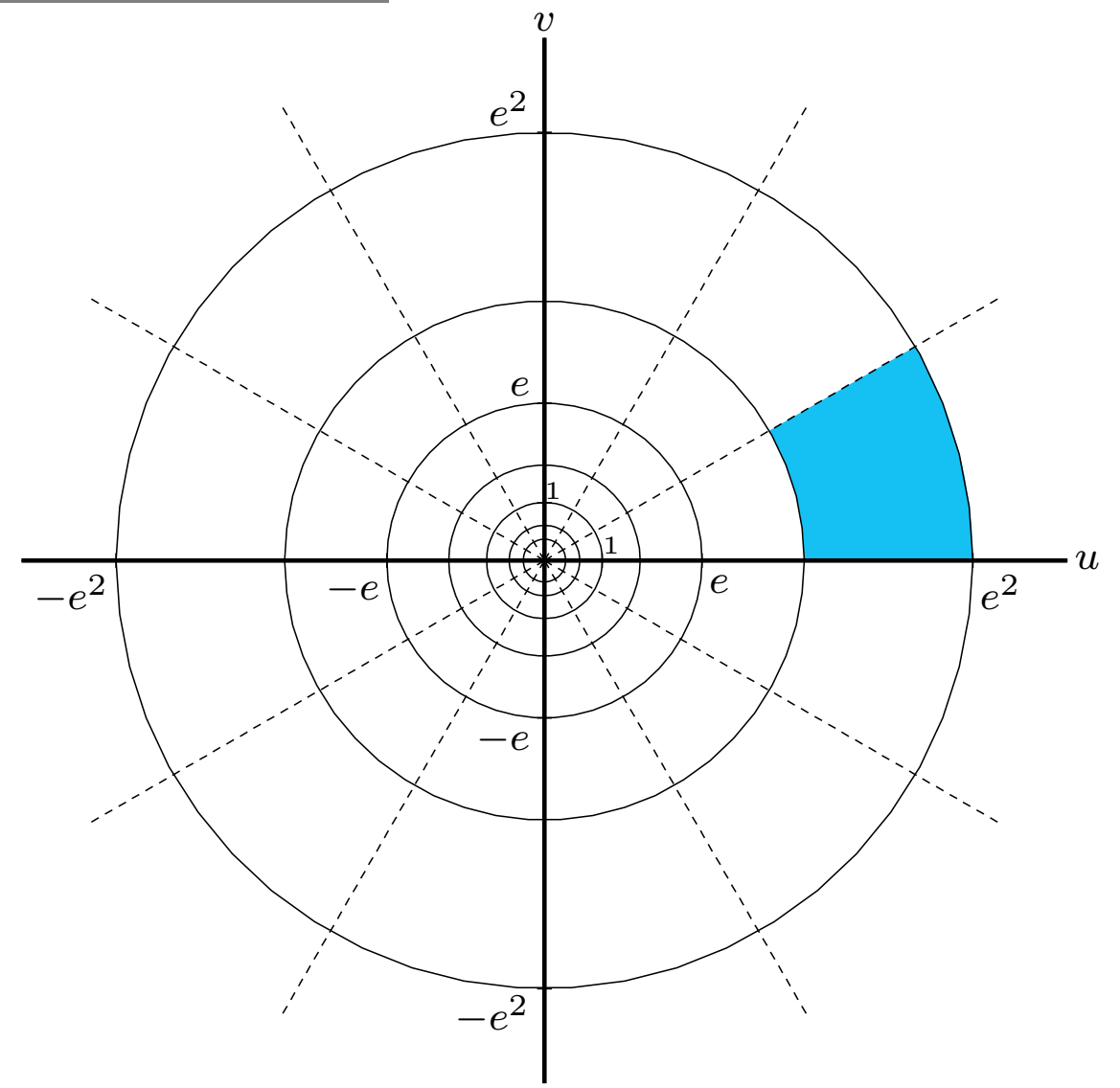
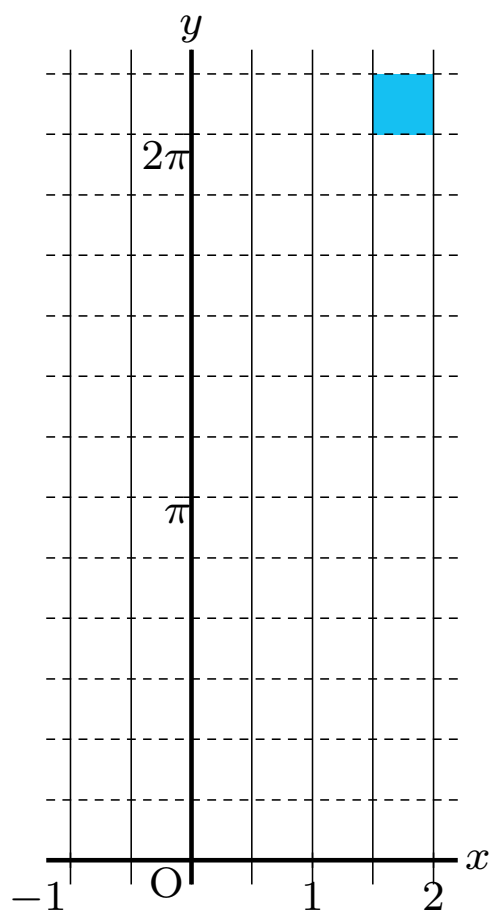

End

$w = e^z$ z -plane \longrightarrow w -plane

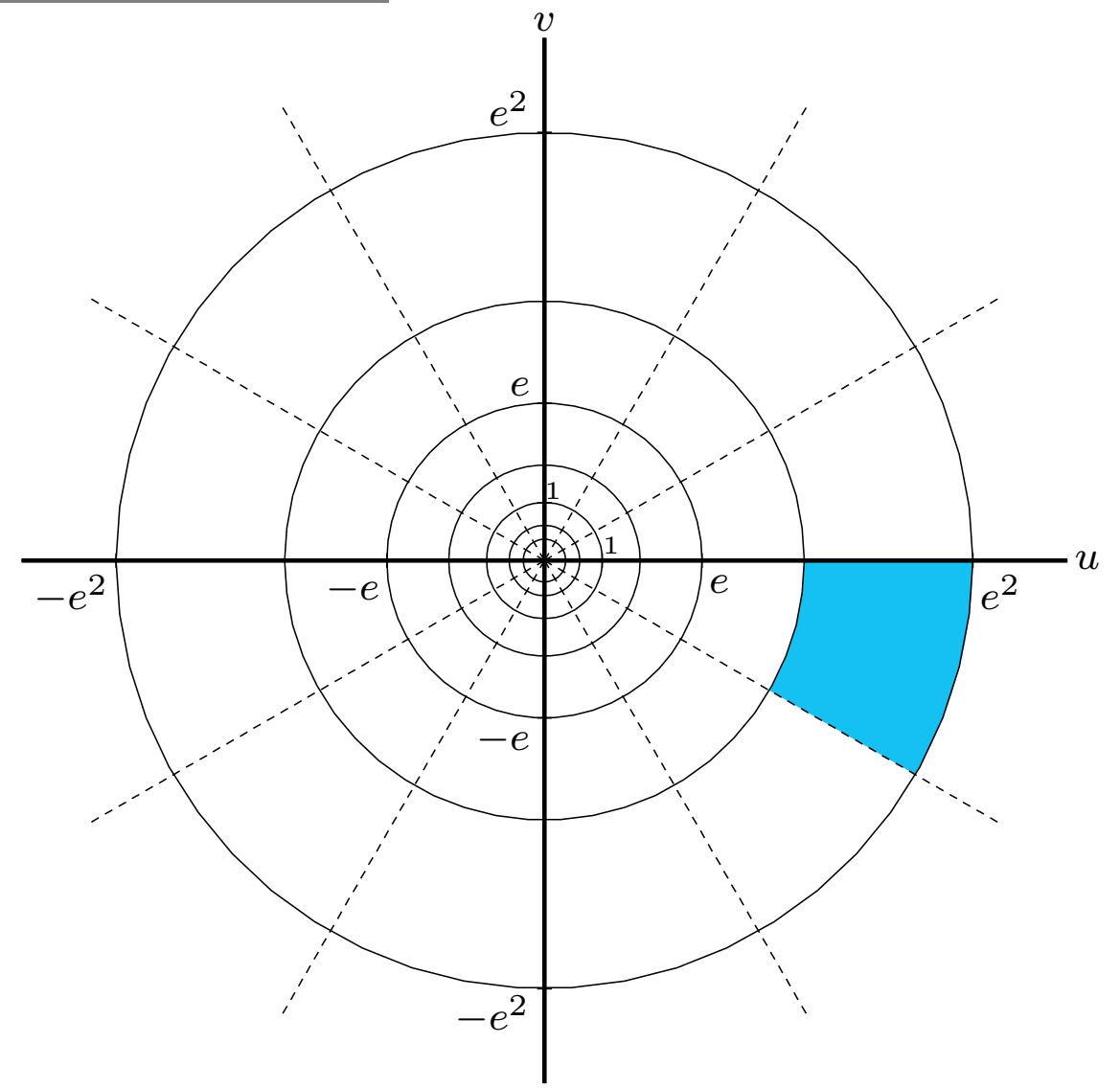
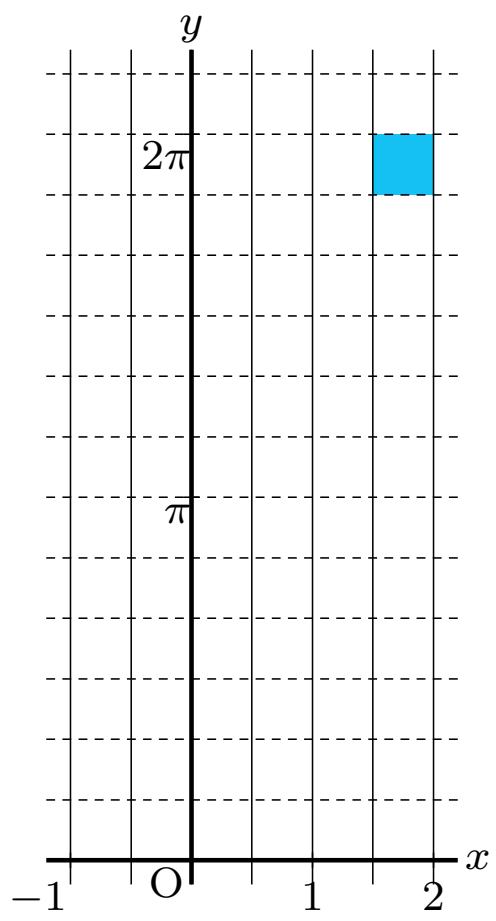

End

$w = e^z$ z -plane \longrightarrow w -plane

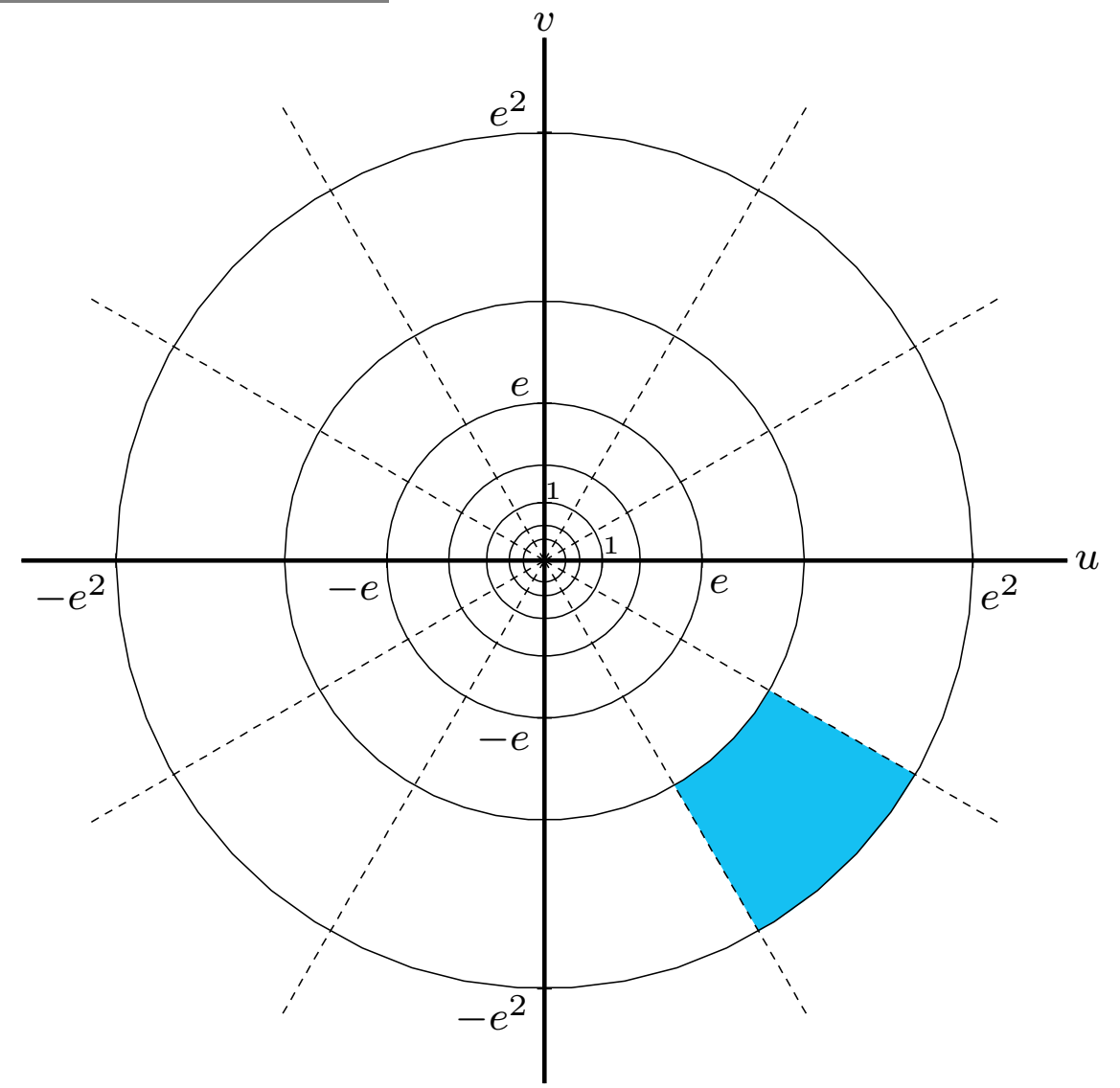
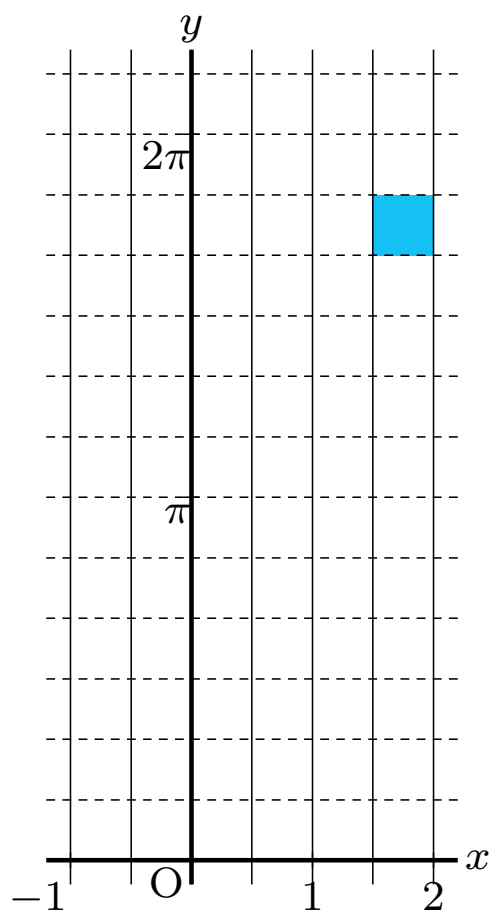

End

$w = e^z$ z -plane \longrightarrow w -plane

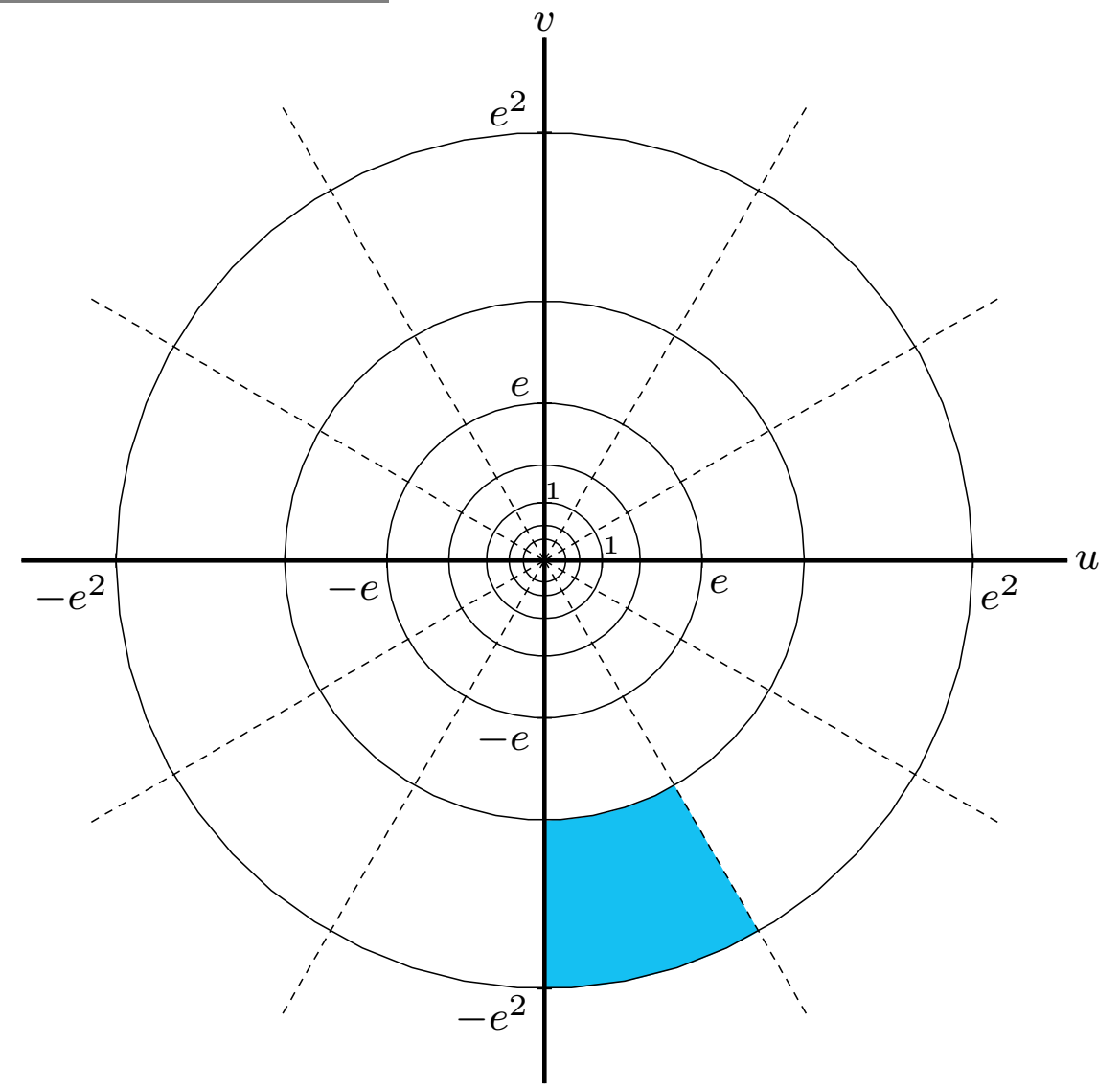
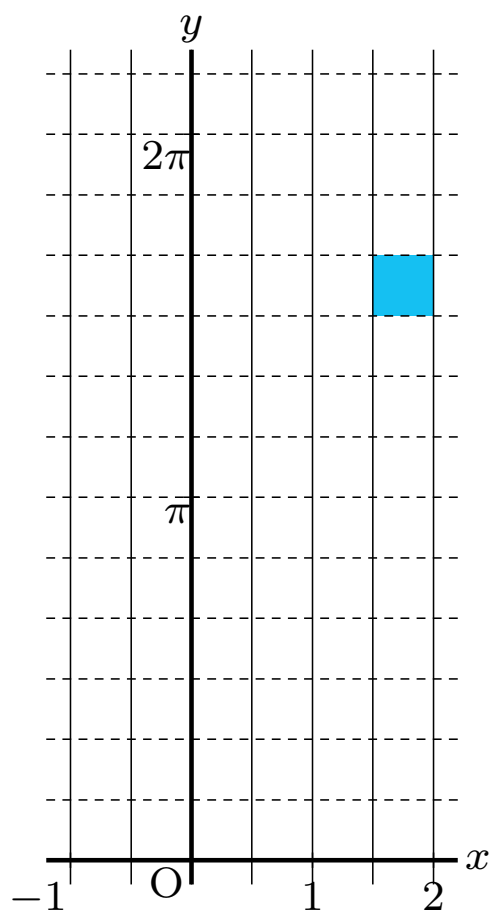

End

$w = e^z$ z -plane \longrightarrow w -plane

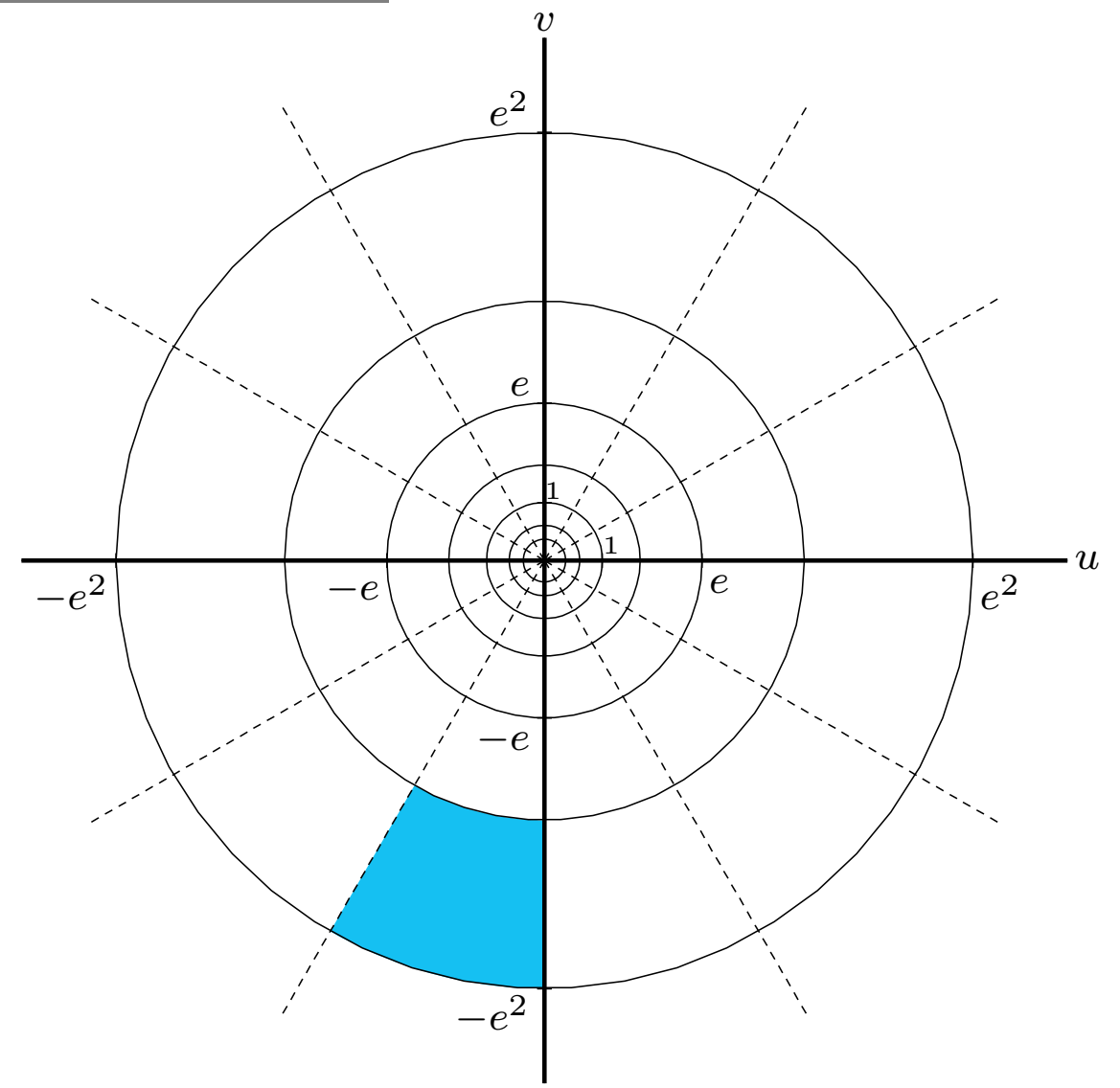
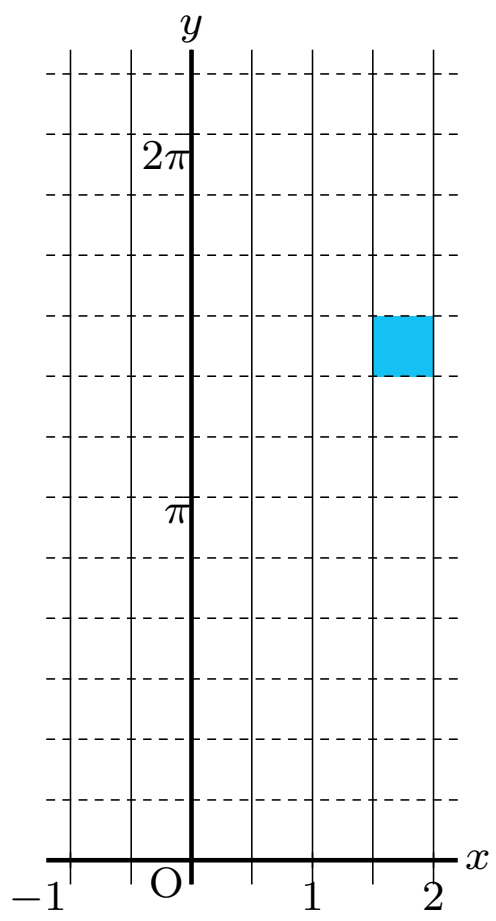

End

$w = e^z$ z -plane \longrightarrow w -plane

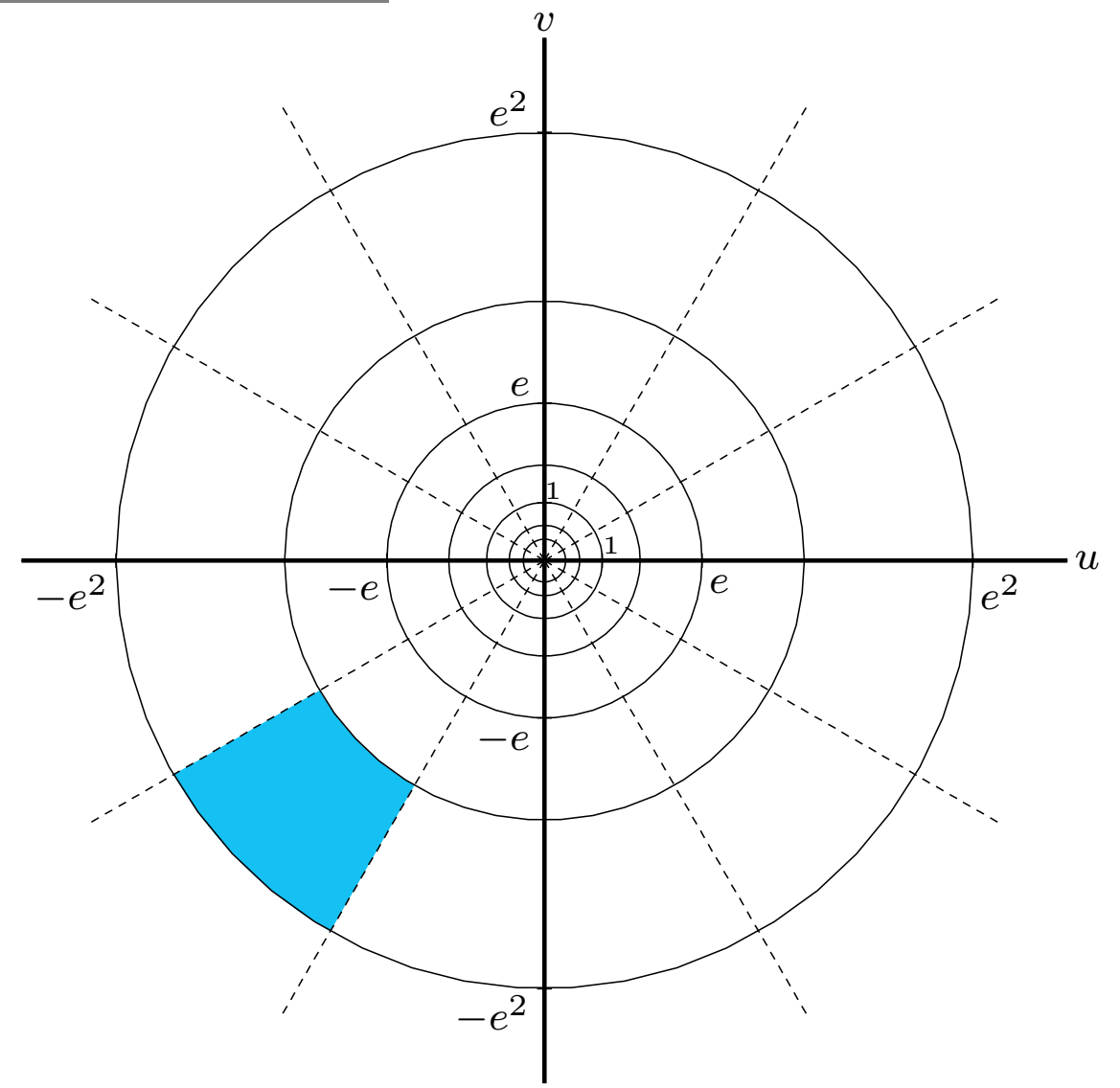
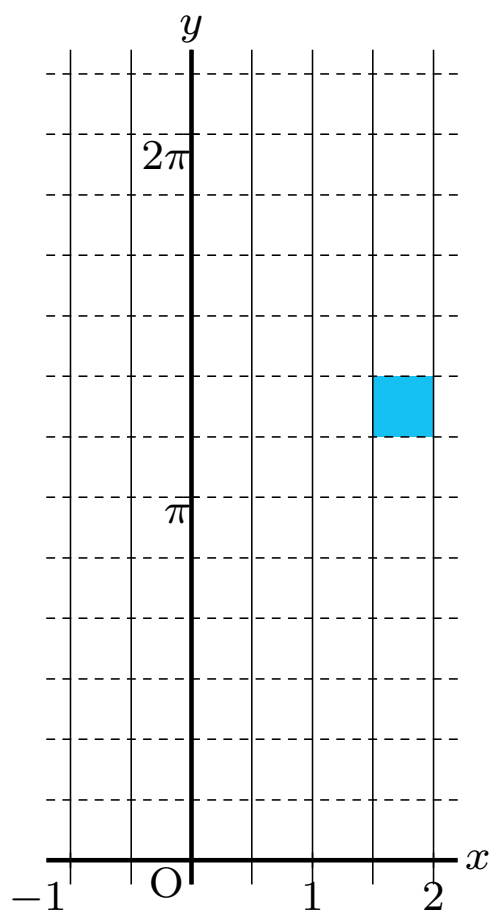

End

$w = e^z$ z -plane \longrightarrow w -plane

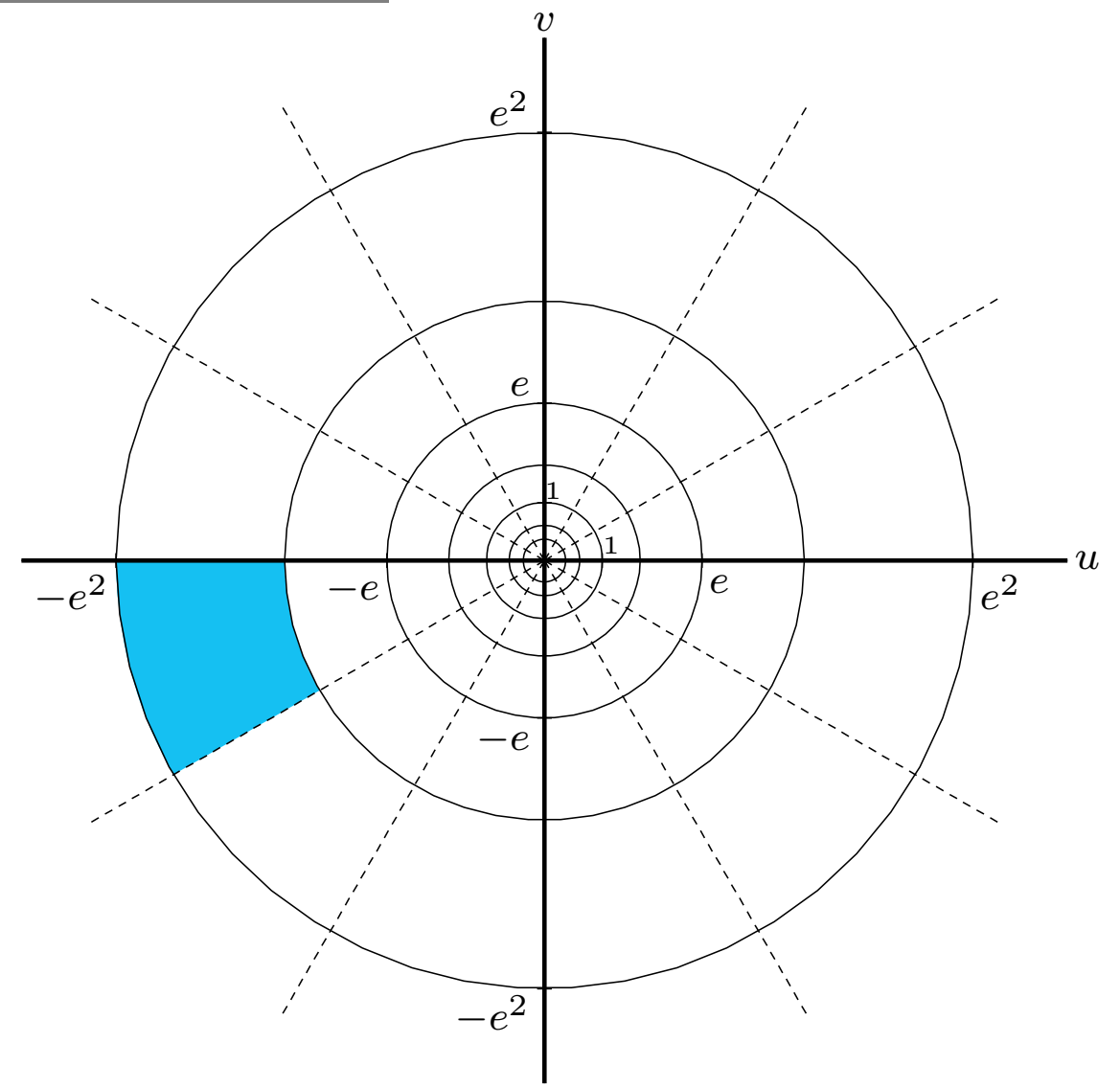
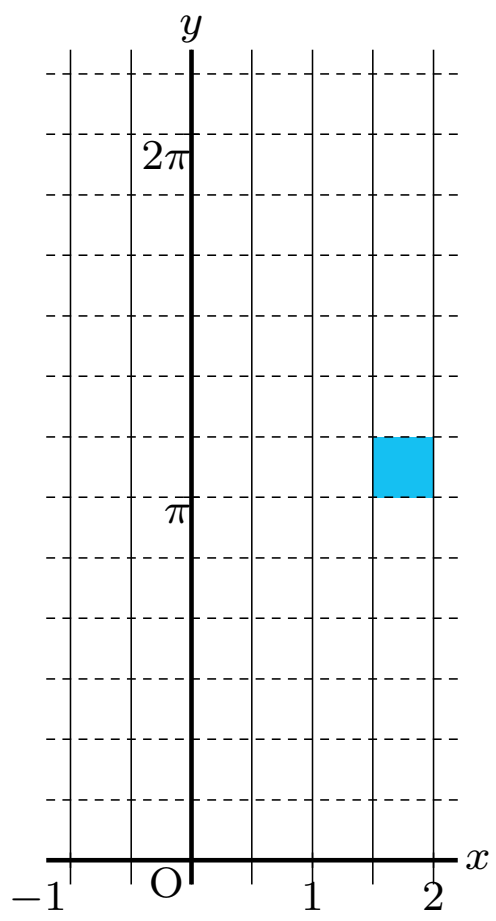

End

$w = e^z$ z -plane \longrightarrow w -plane

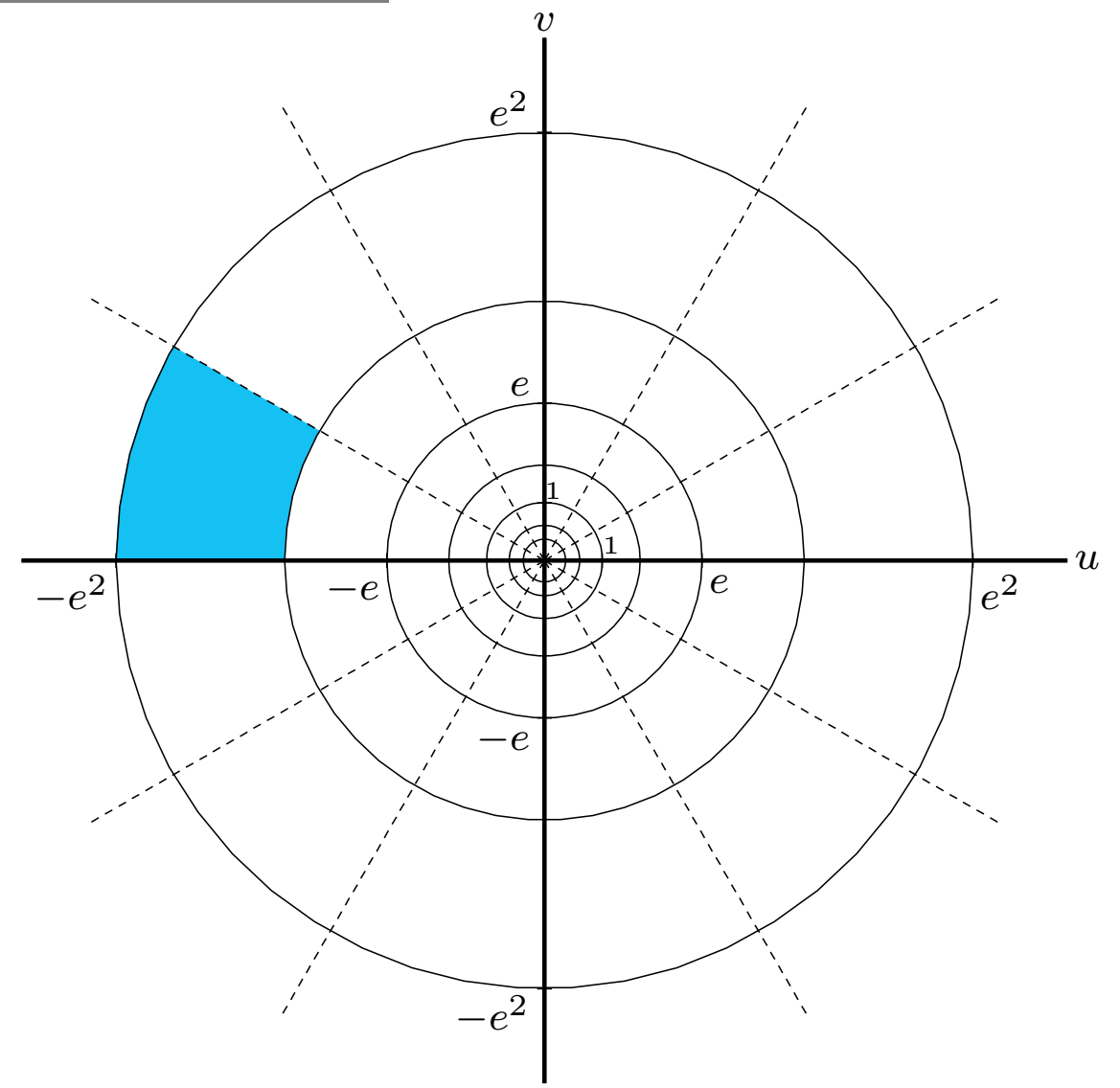
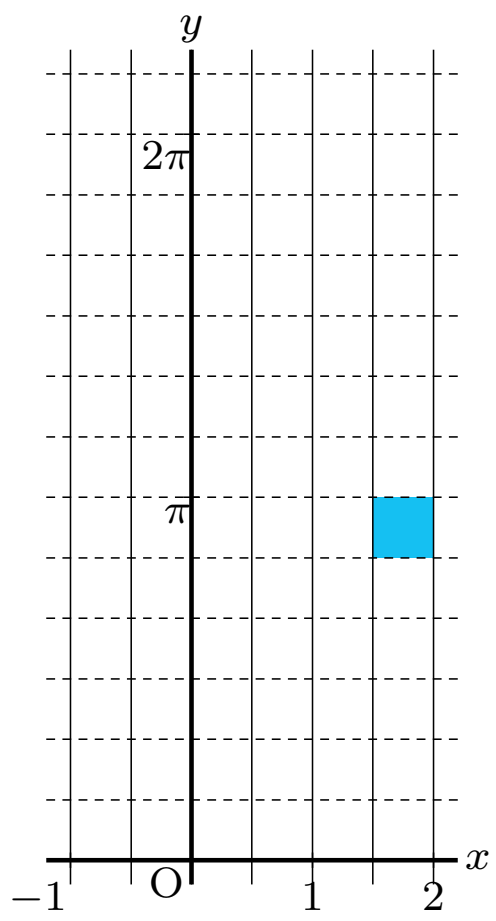

End

$w = e^z$ z -plane \longrightarrow w -plane

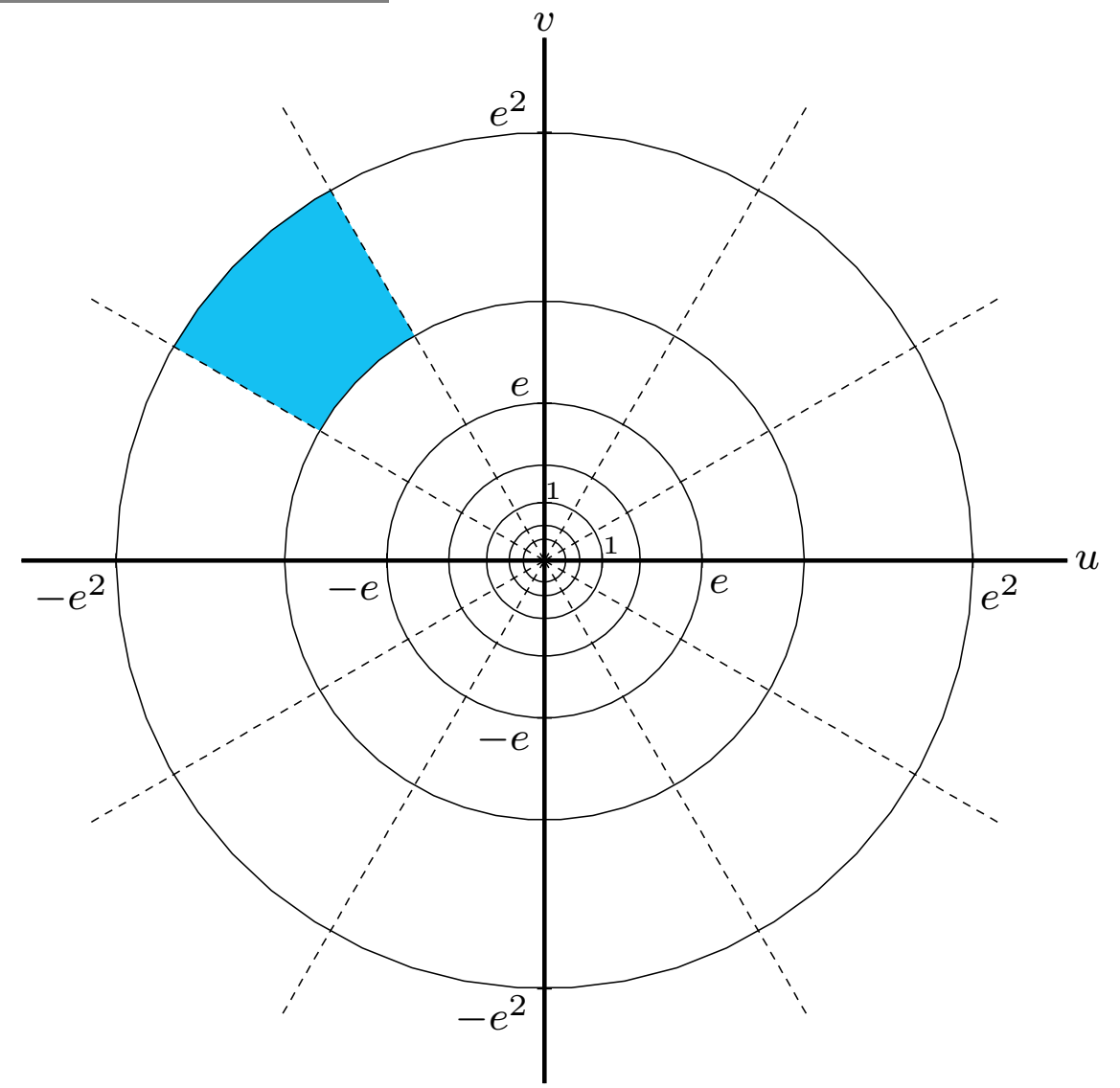
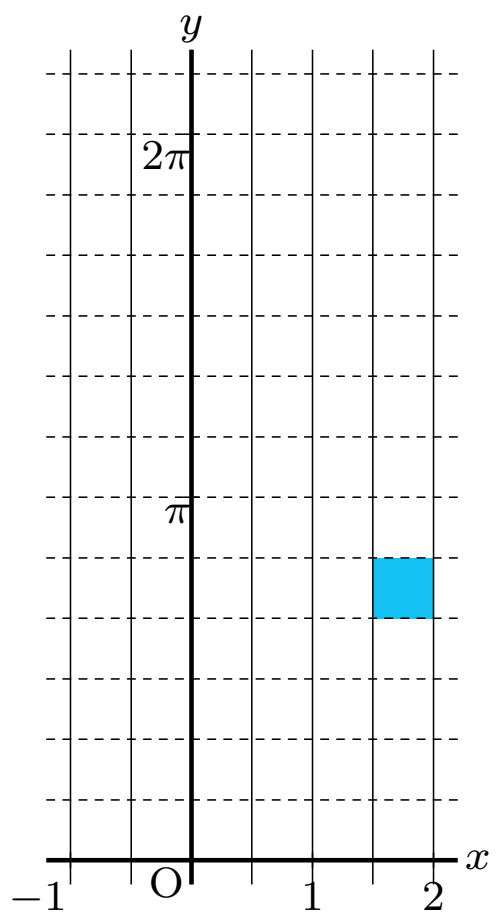

End

$w = e^z$ z -plane \longrightarrow w -plane

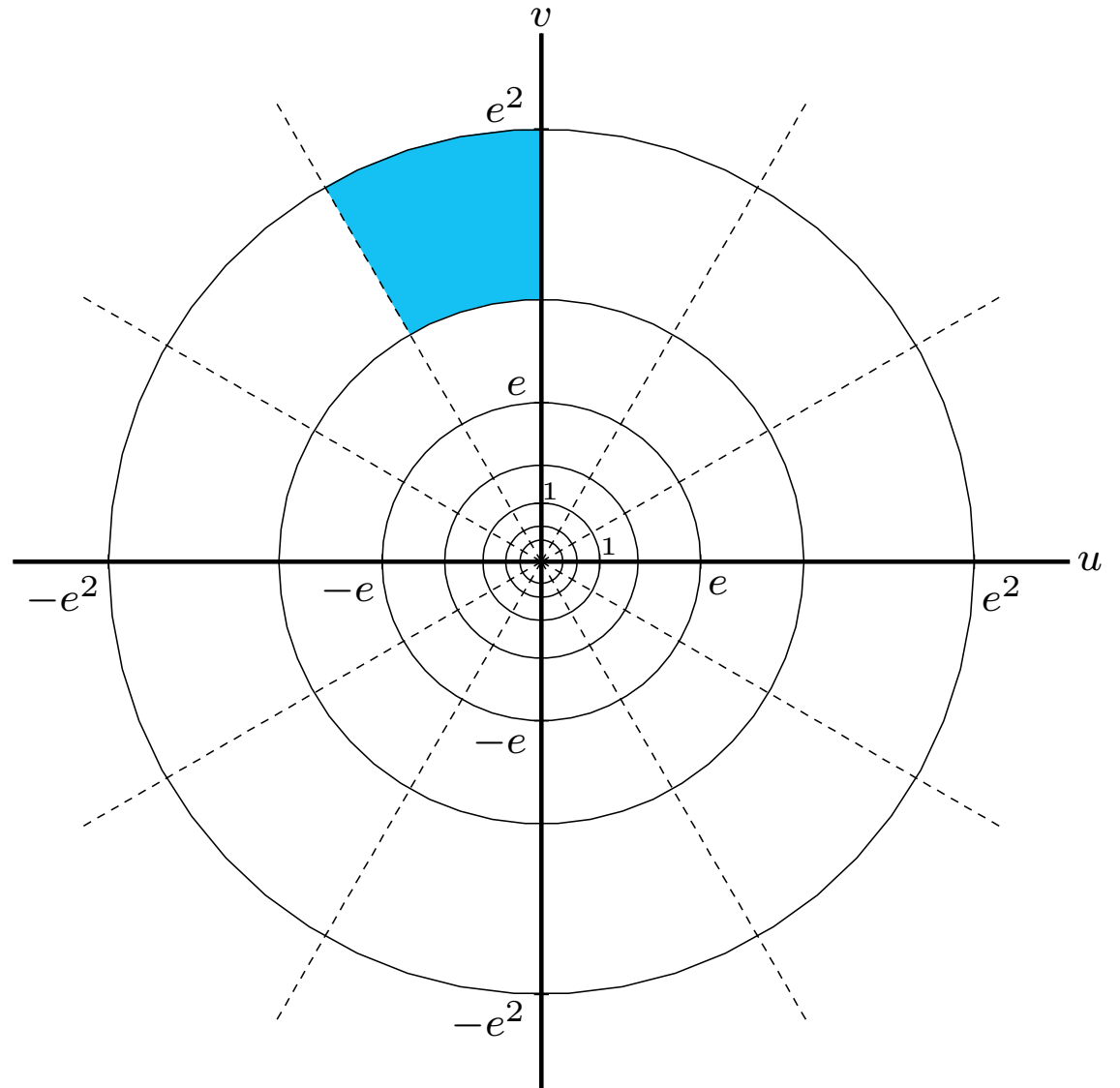
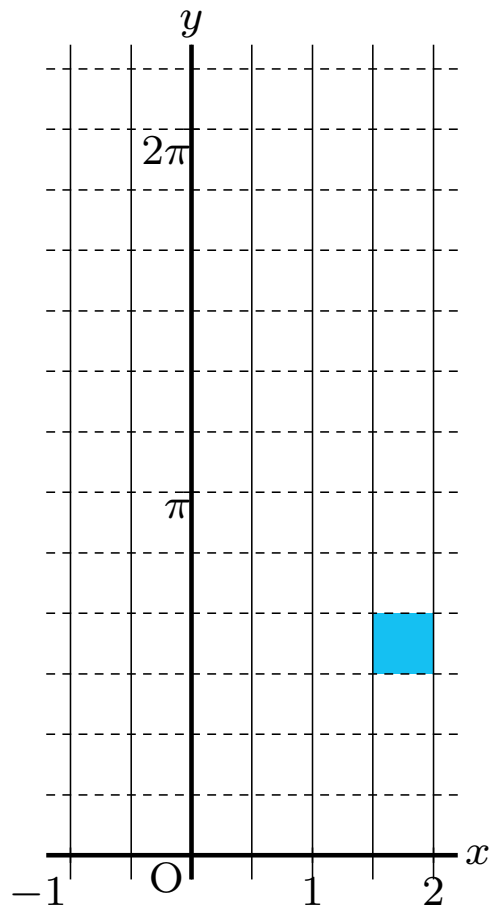

End

$w = e^z$ z -plane \longrightarrow w -plane

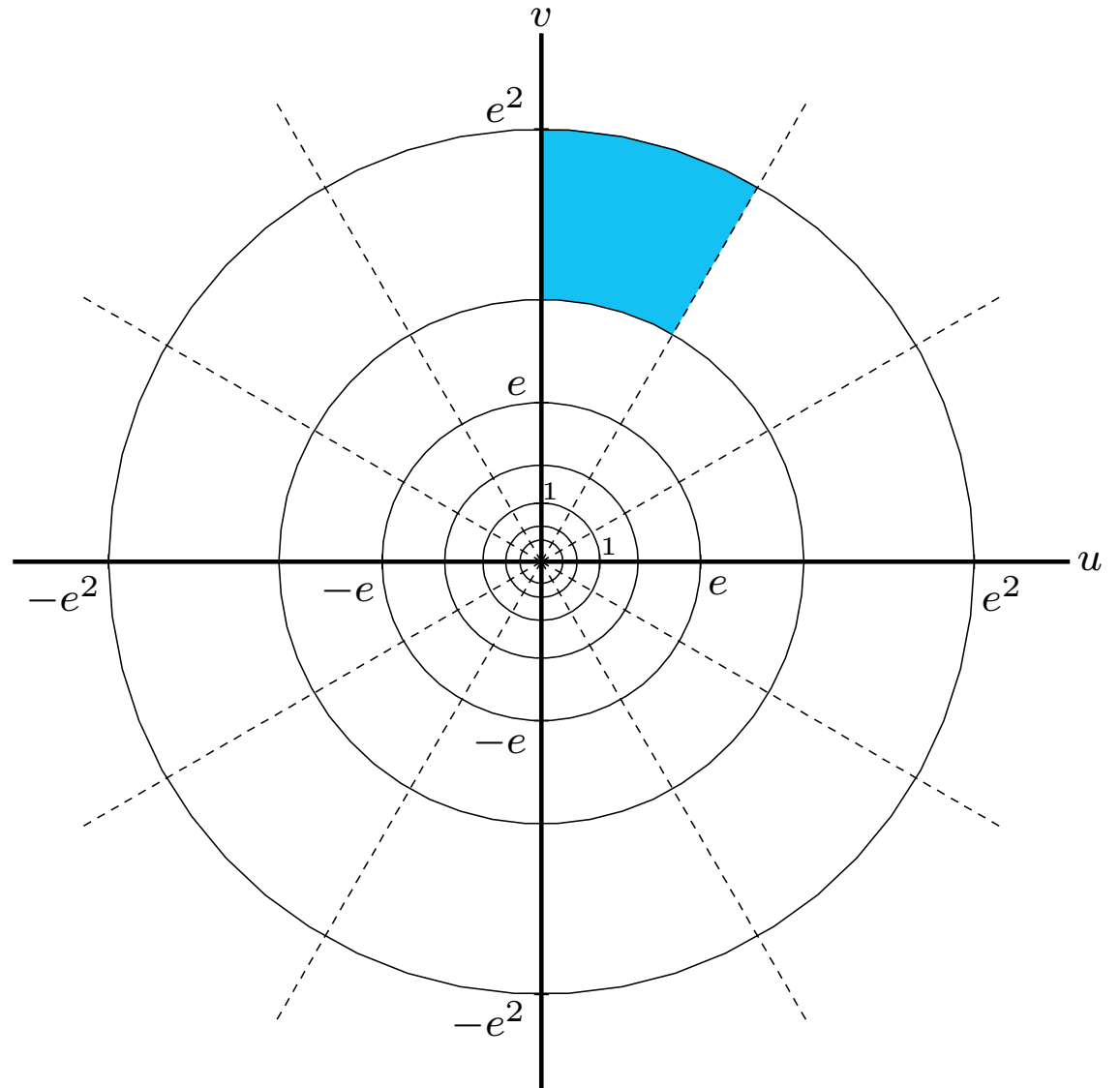
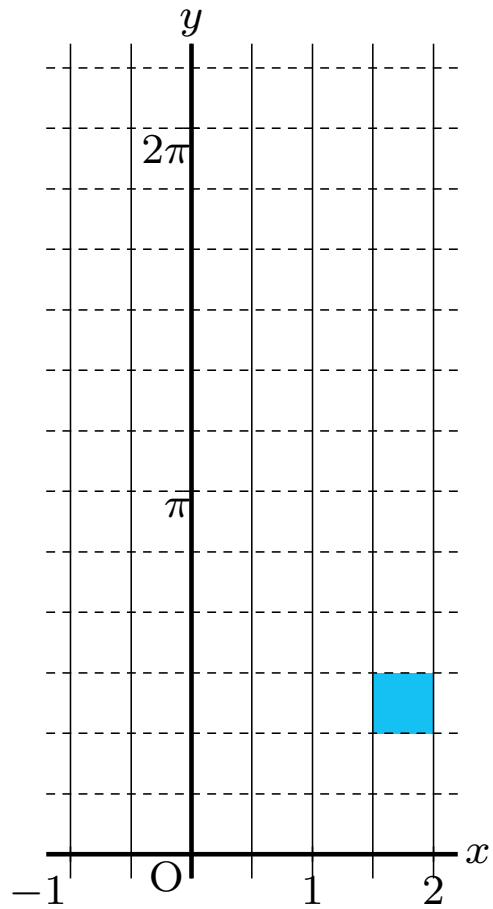

End

$w = e^z$ z -plane \longrightarrow w -plane

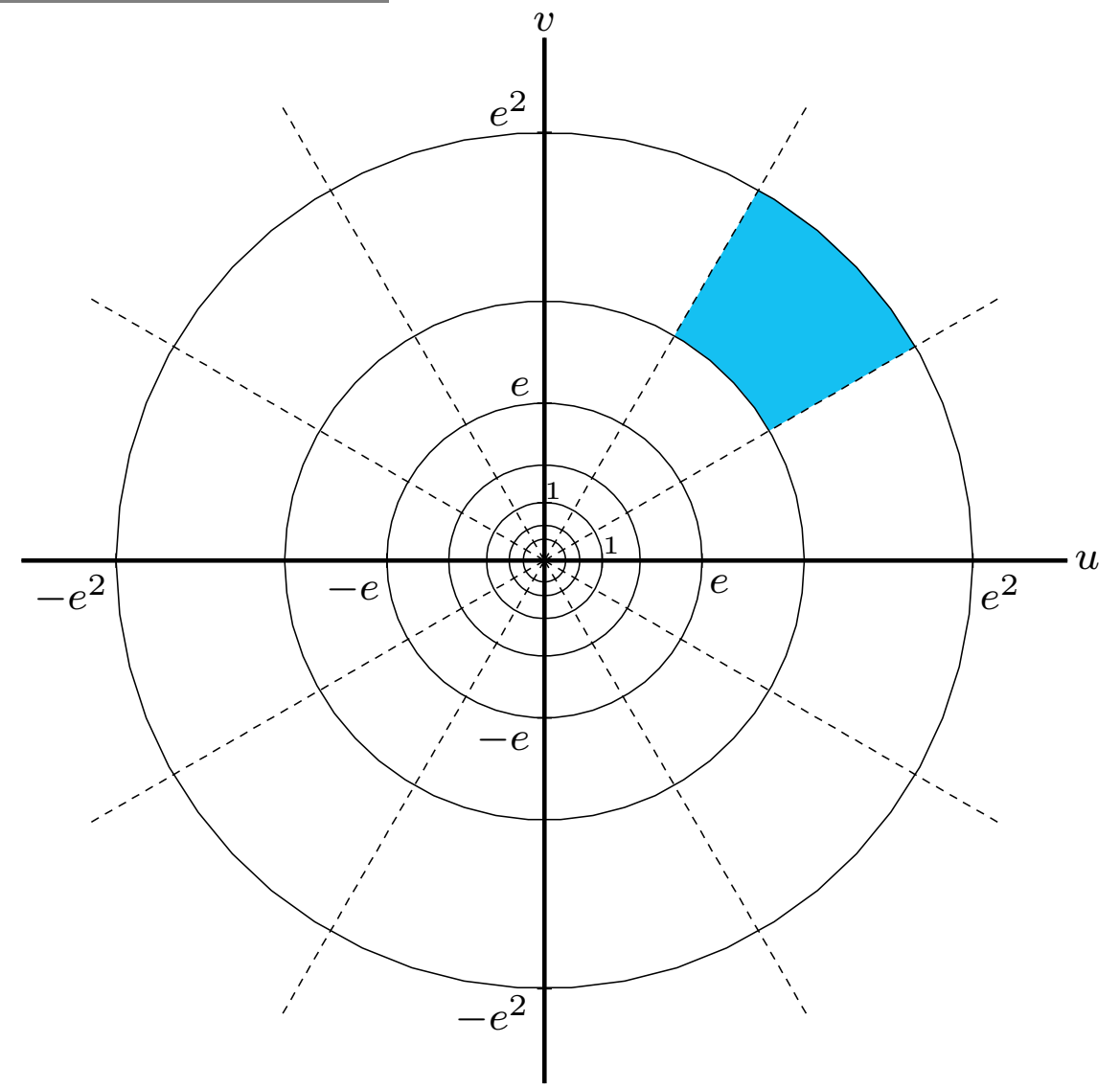
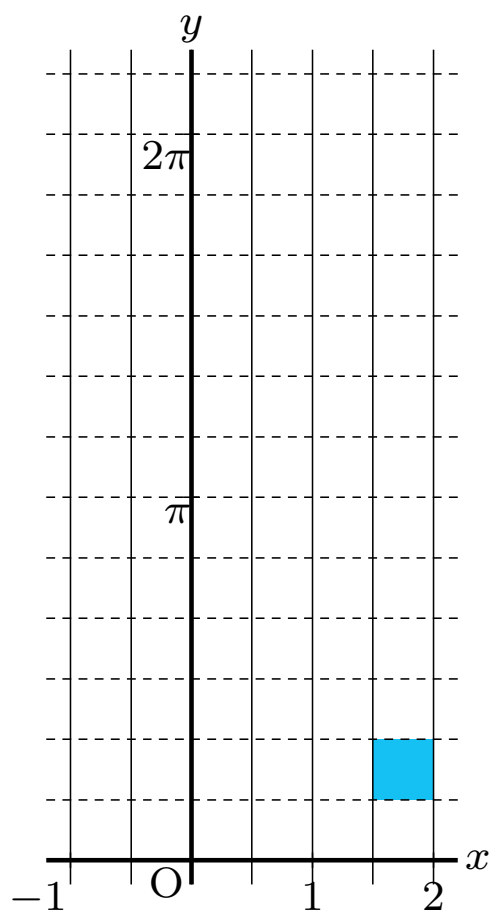

End

$w = e^z$ z -plane \longrightarrow w -plane

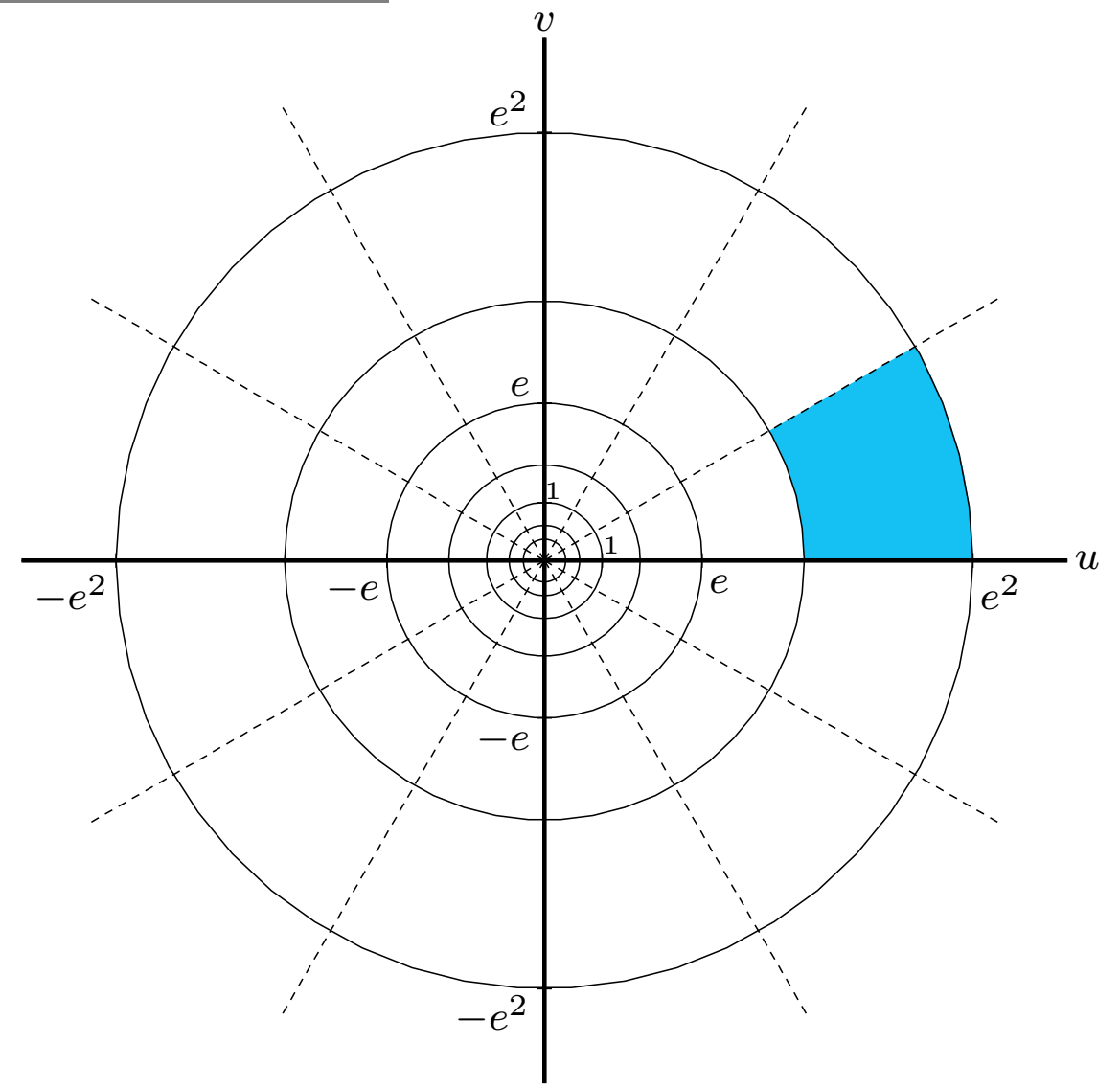
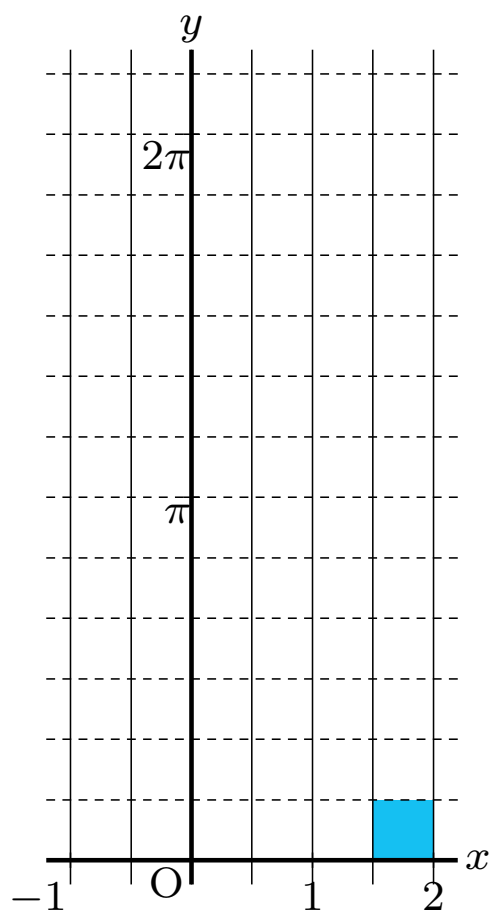

End

$w = e^z$ z -plane \longrightarrow w -plane

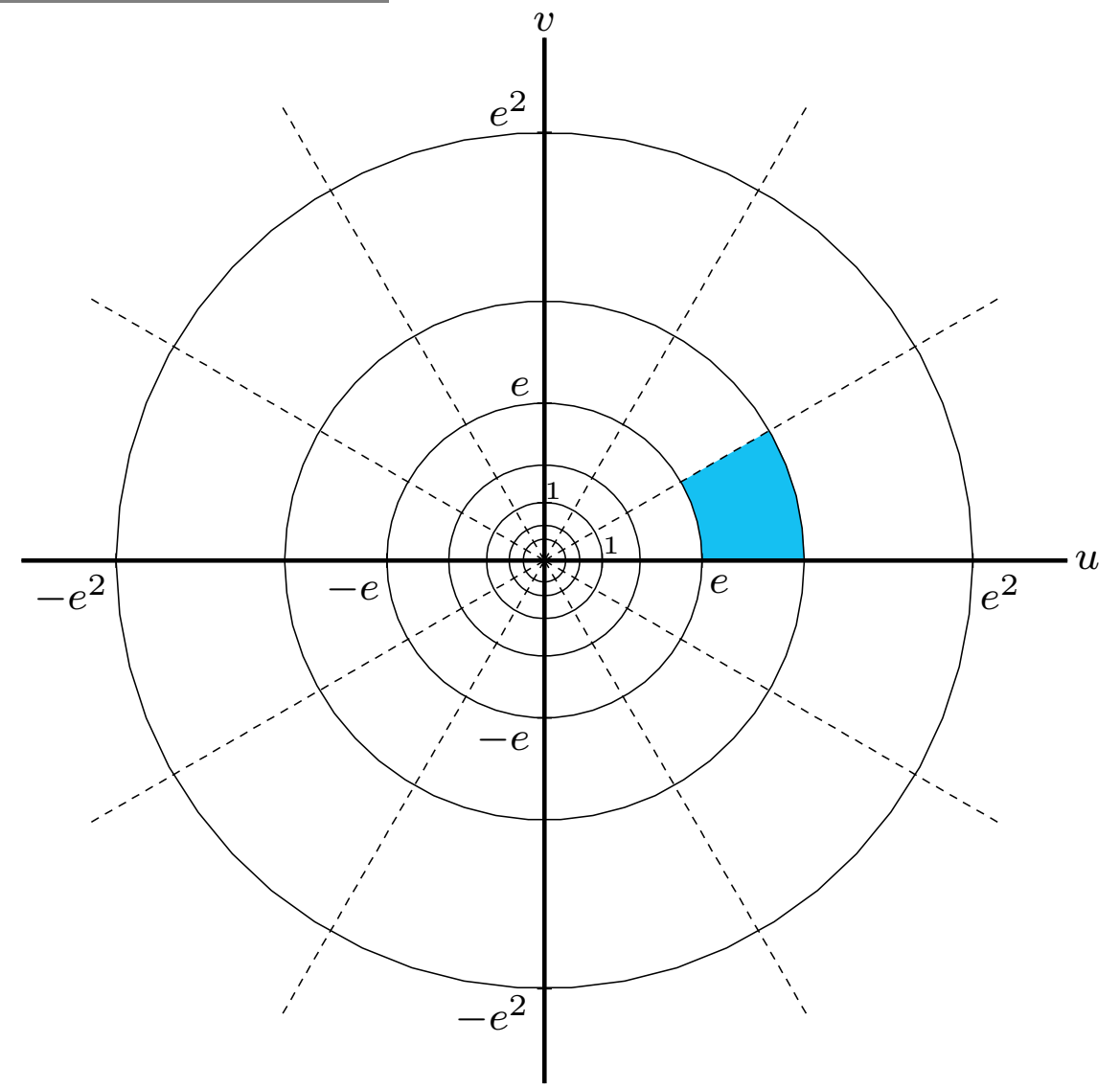
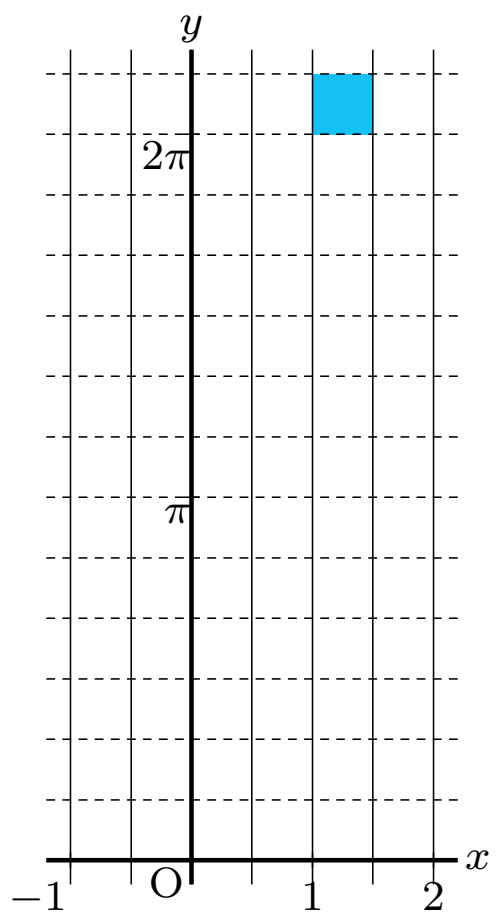

End

$w = e^z$ z -plane \longrightarrow w -plane

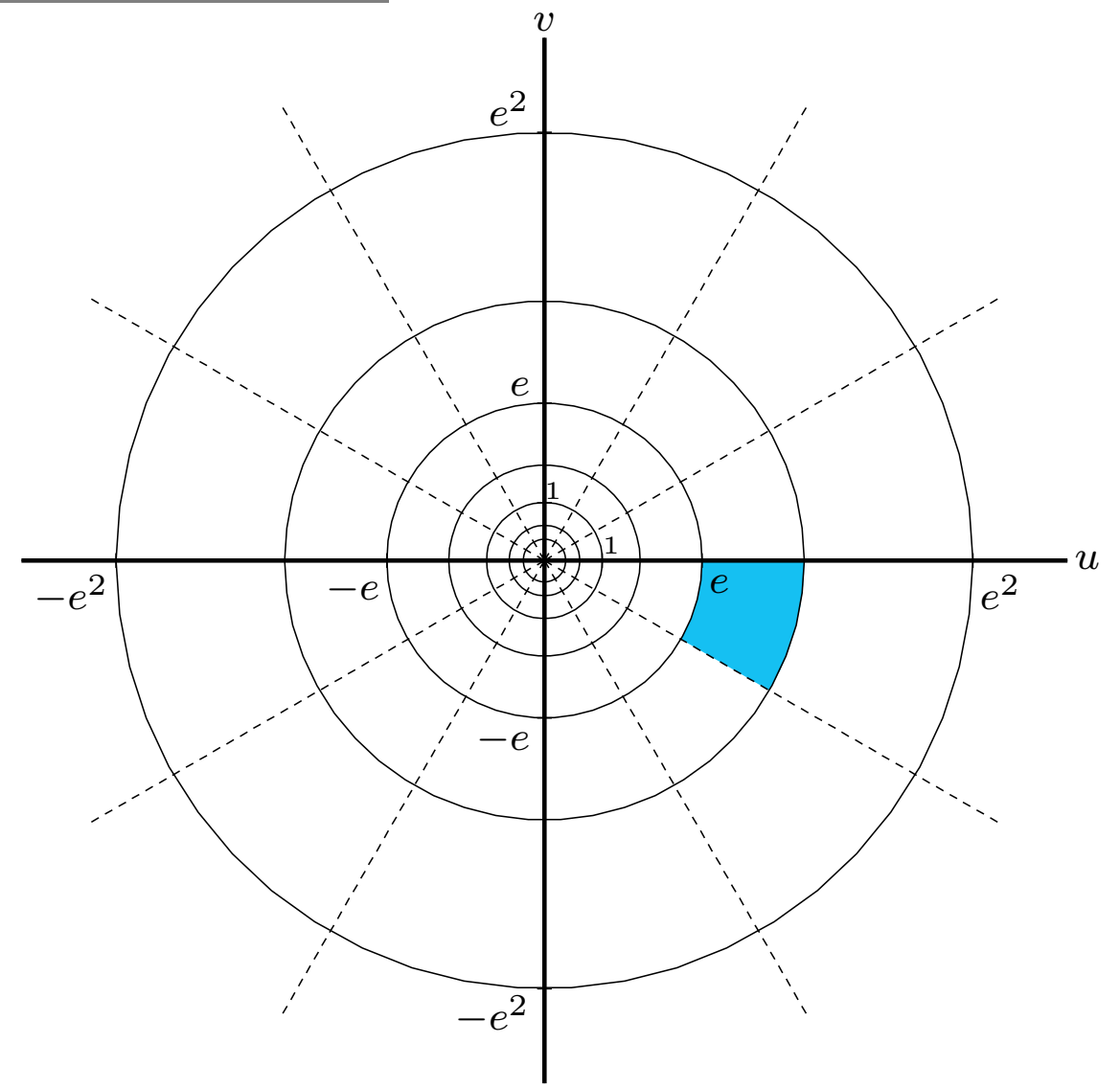
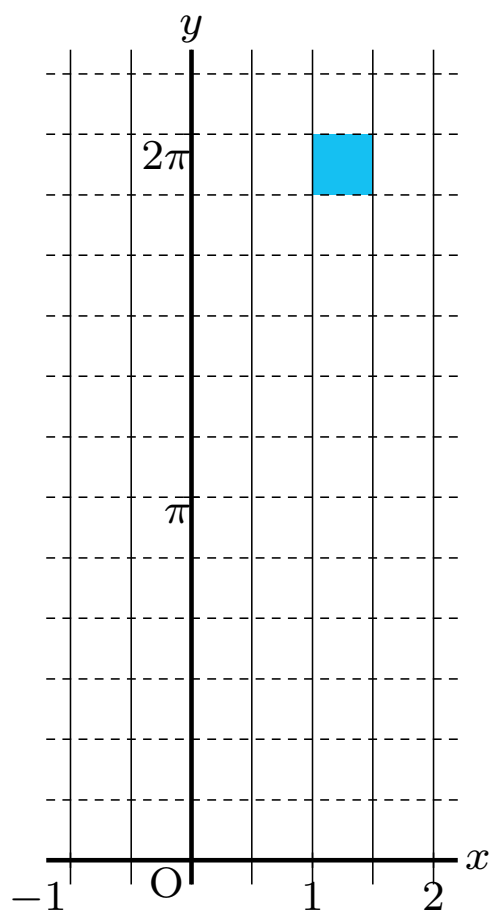

End

$w = e^z$ z -plane \longrightarrow w -plane

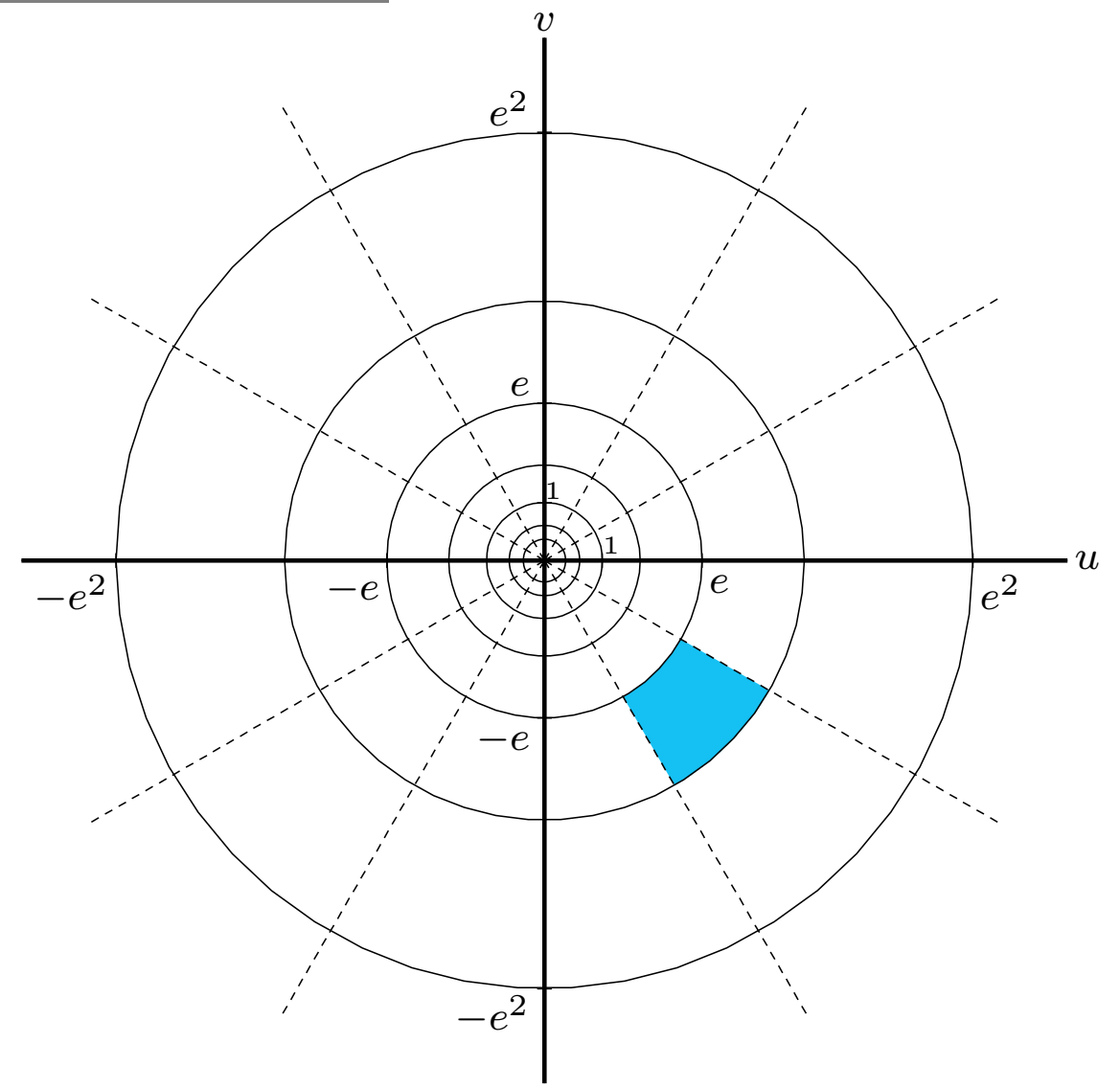
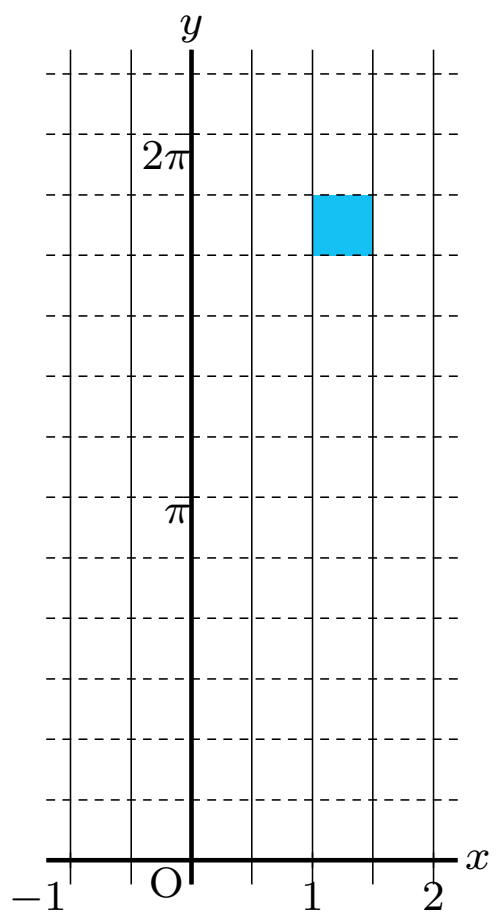

End

$w = e^z$ z -plane \longrightarrow w -plane

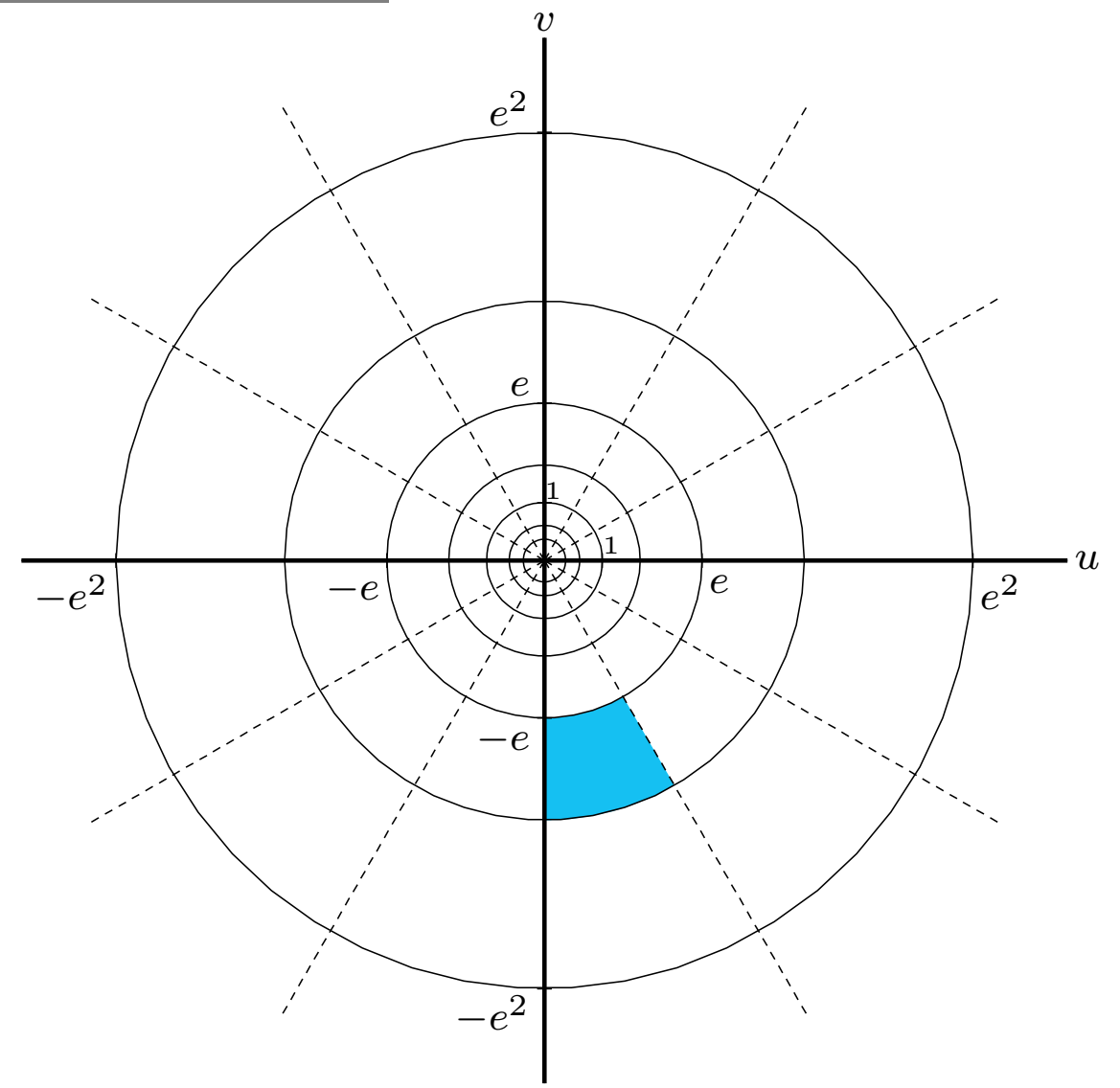
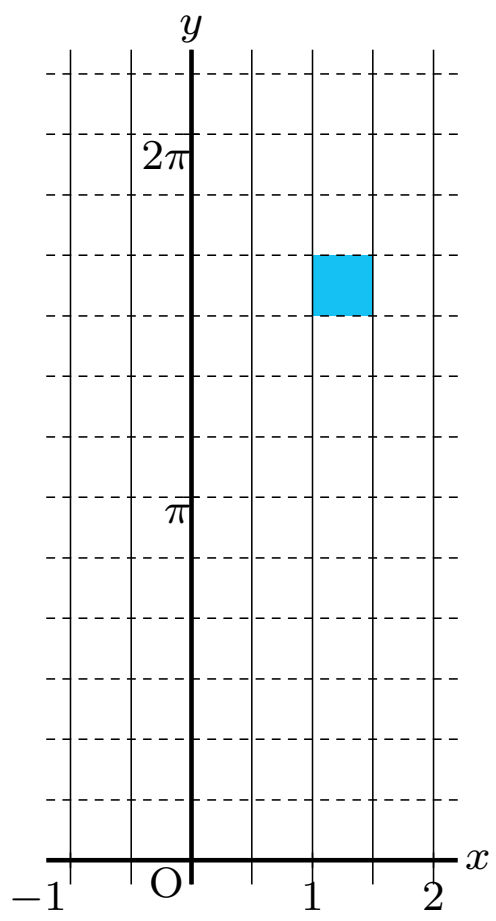

End

$w = e^z$ z -plane \longrightarrow w -plane

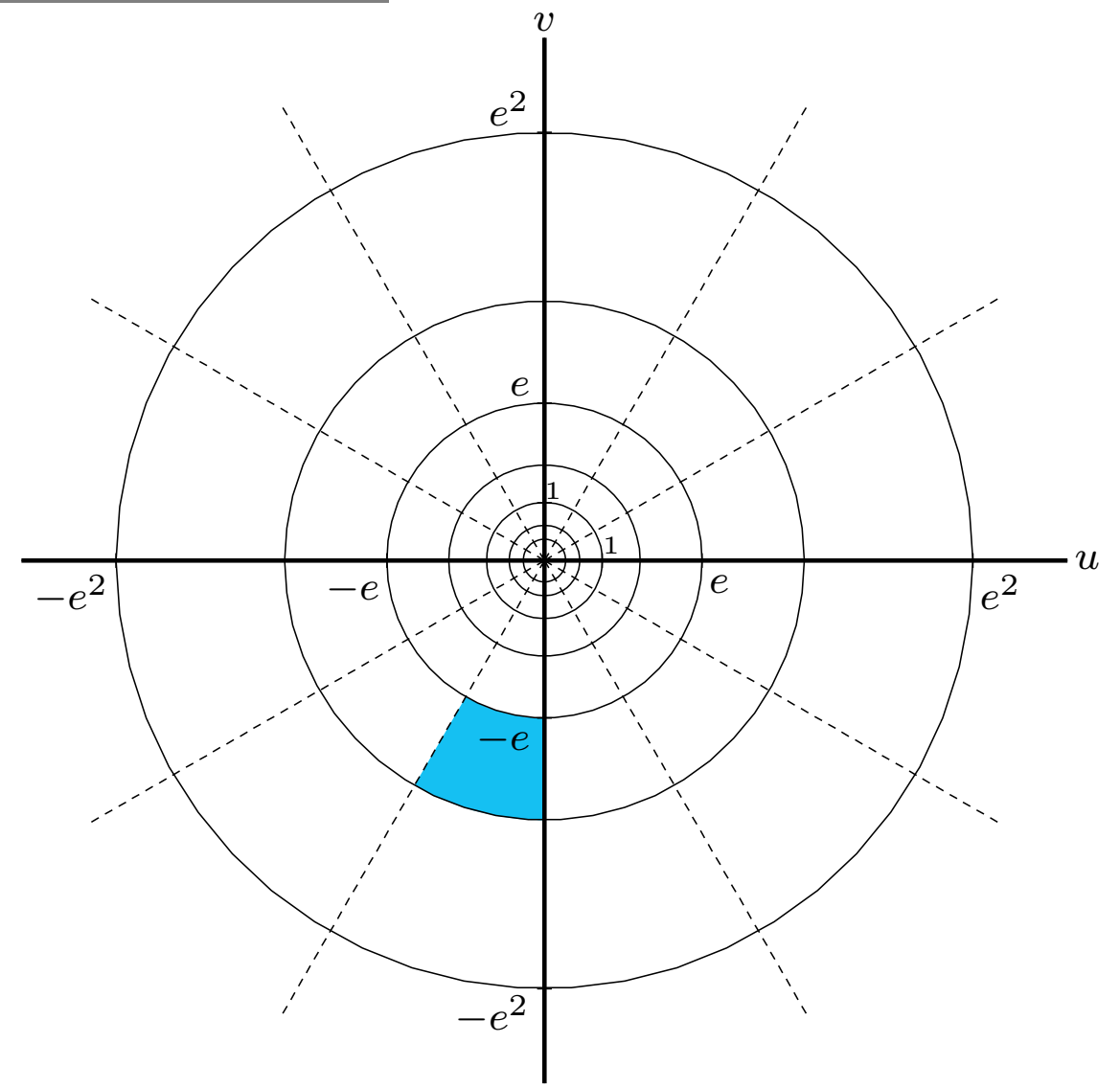
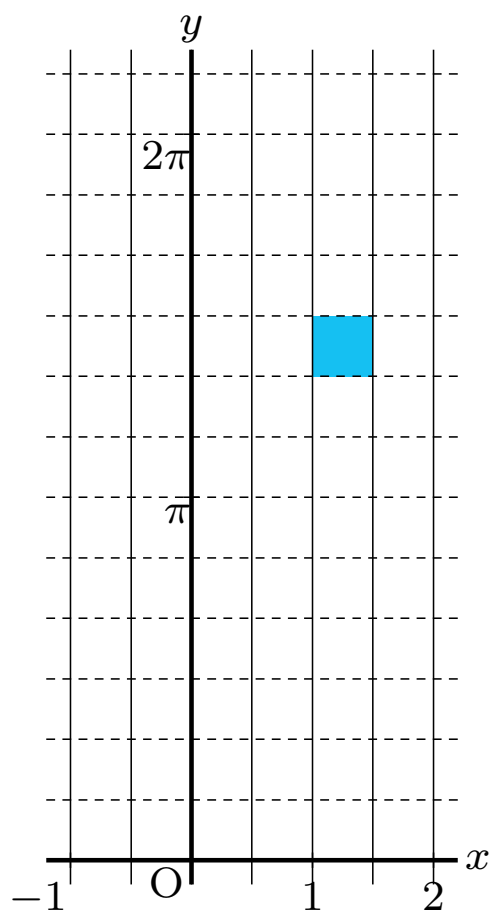

End

$w = e^z$ z -plane \longrightarrow w -plane

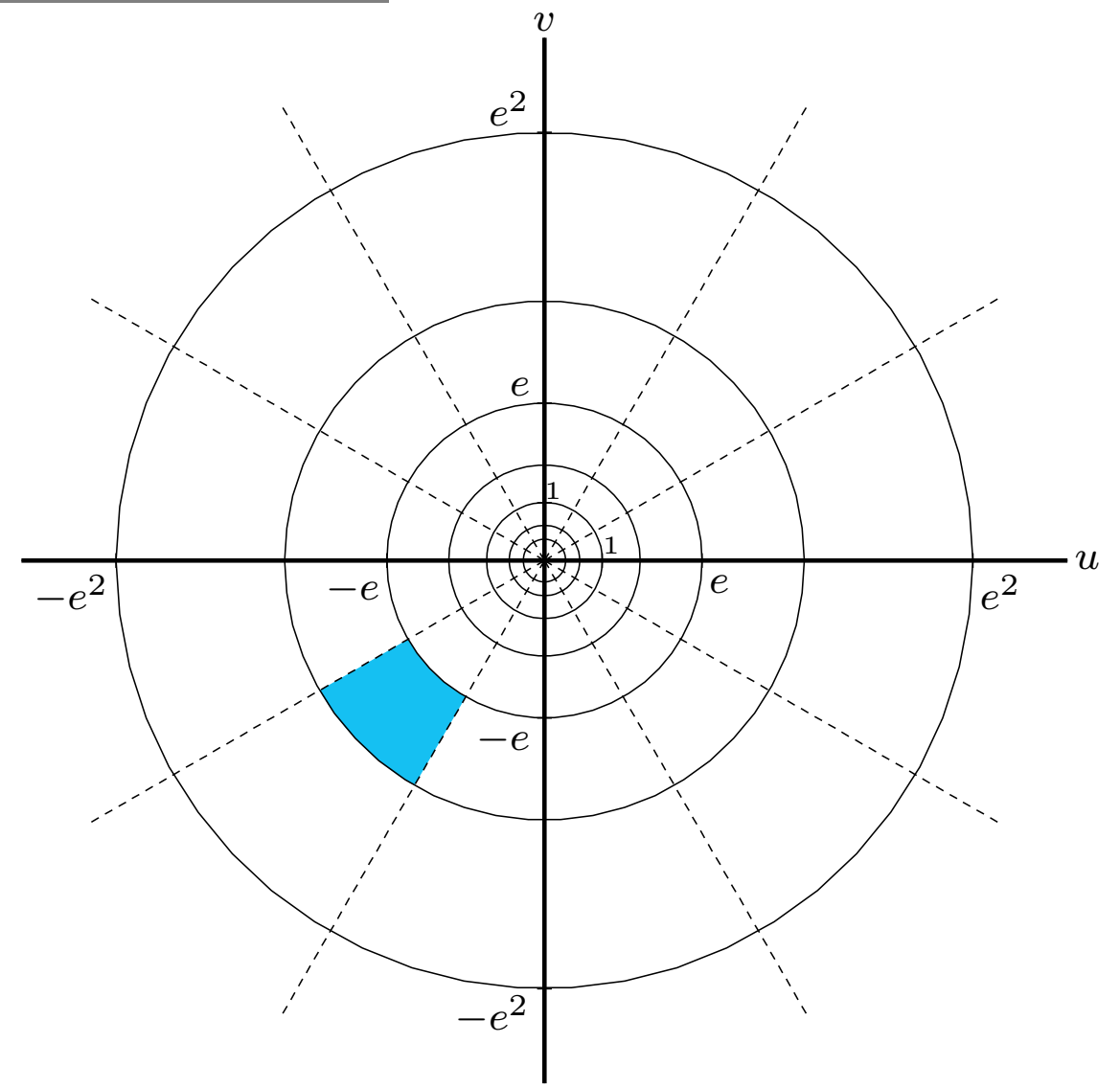
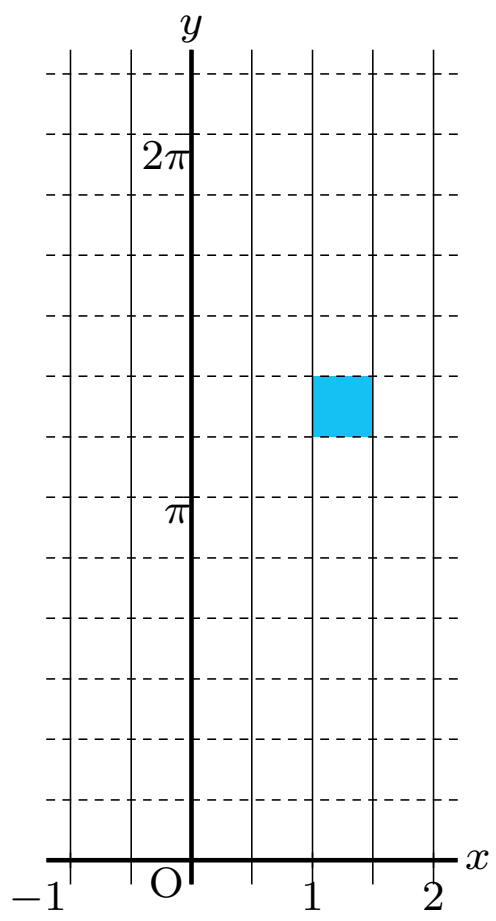

End

$w = e^z$ z -plane \longrightarrow w -plane

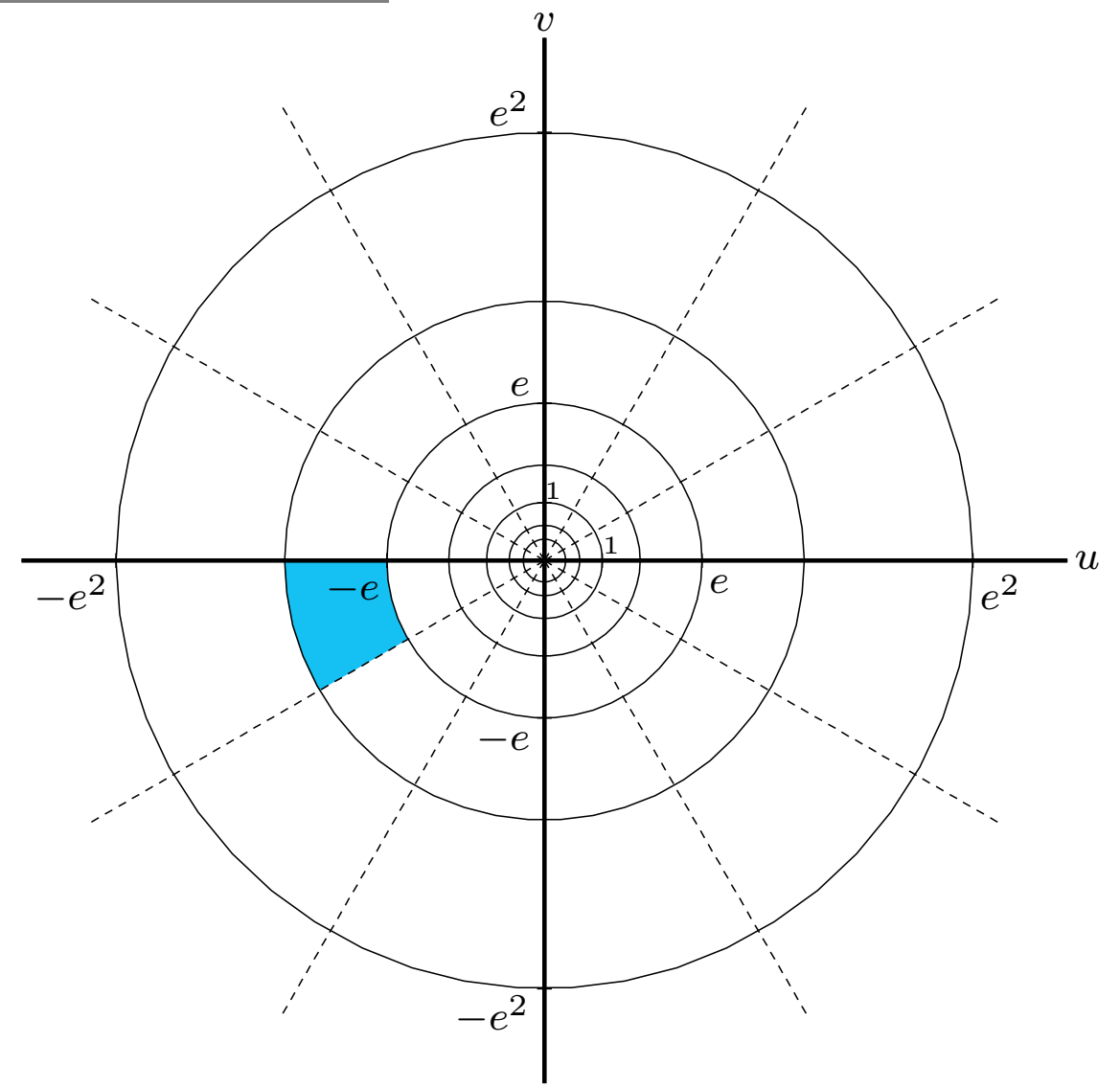
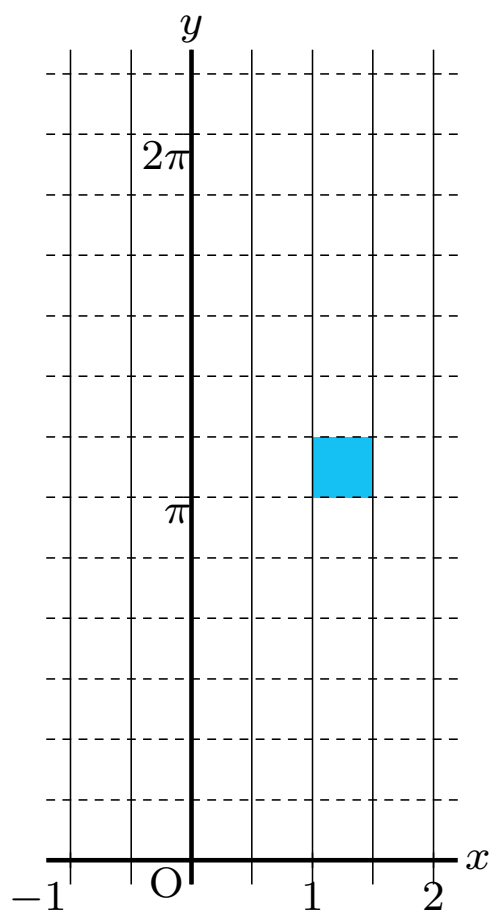

End

$w = e^z$ z -plane \longrightarrow w -plane

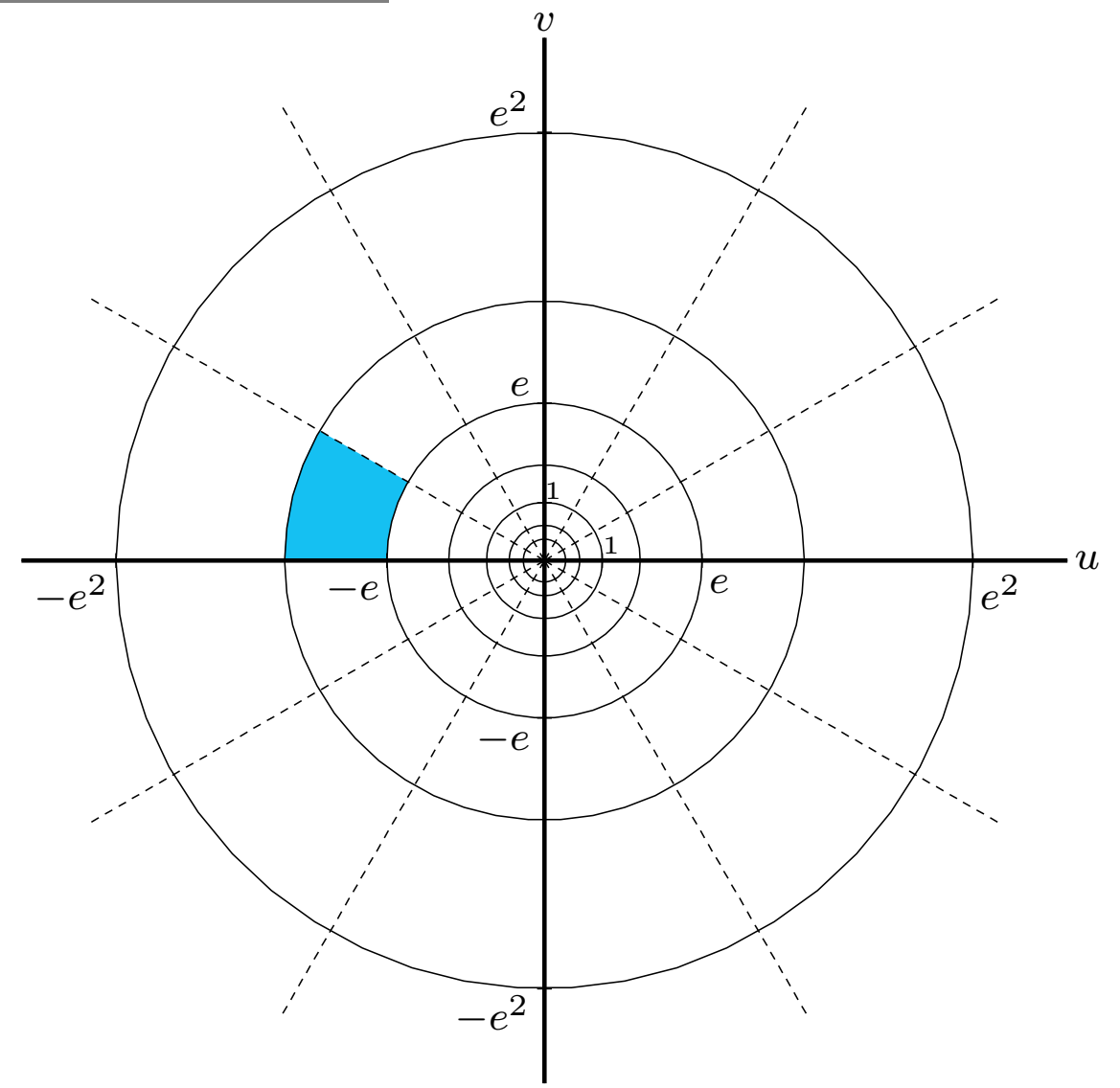
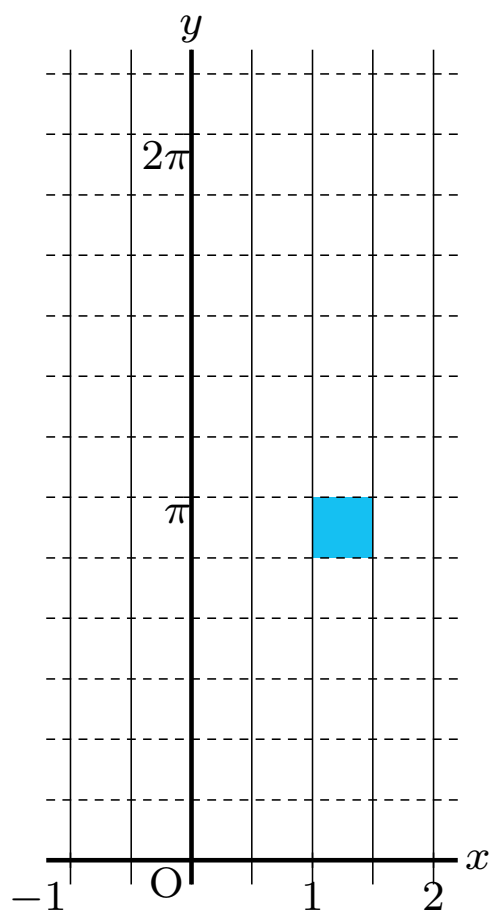

End

$w = e^z$ z -plane \longrightarrow w -plane

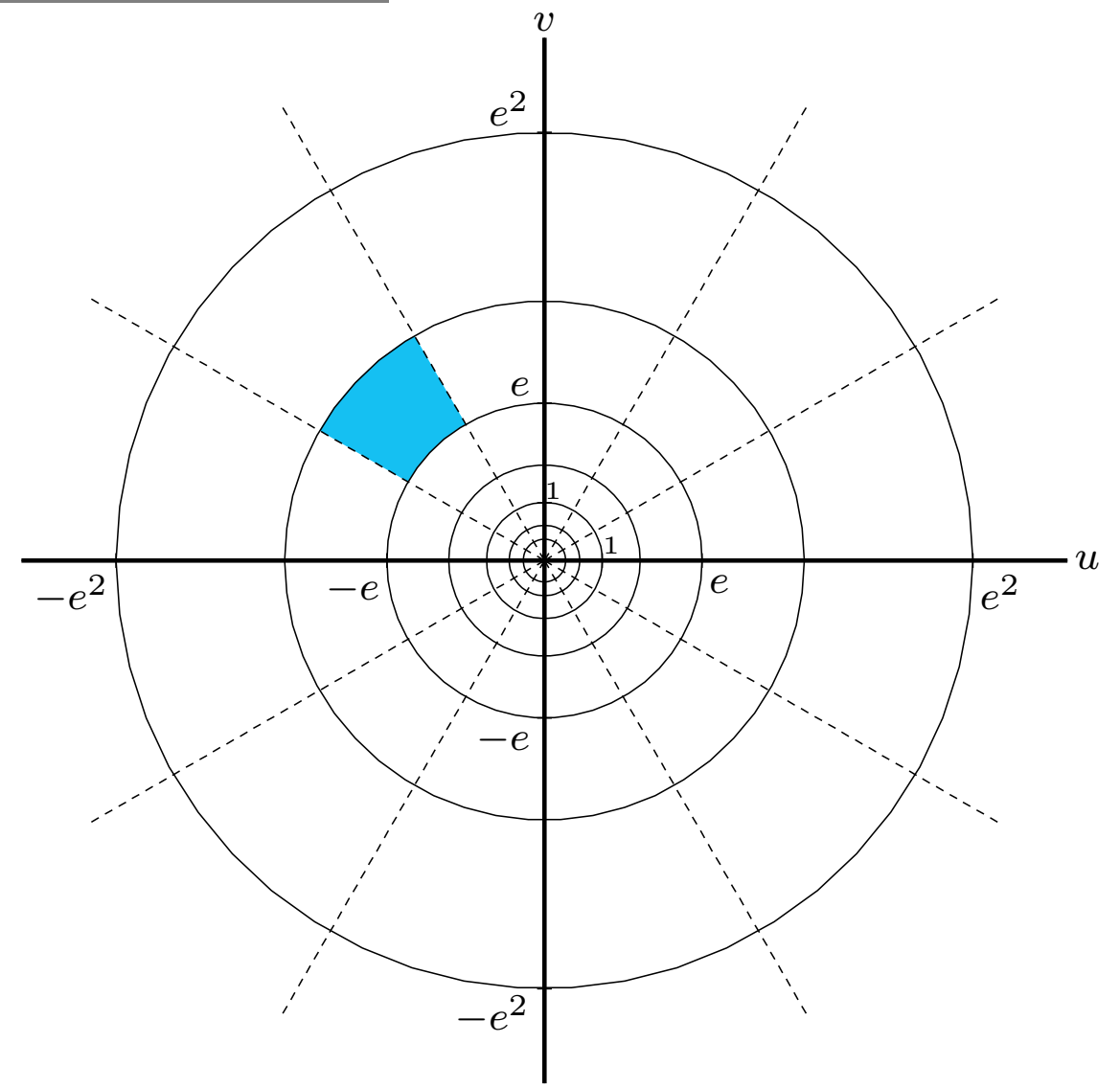
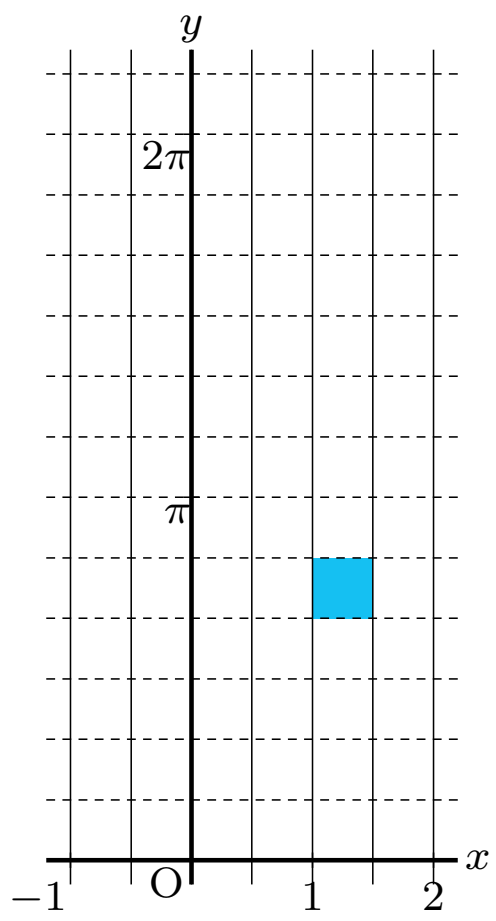

End

$w = e^z$ z -plane \longrightarrow w -plane

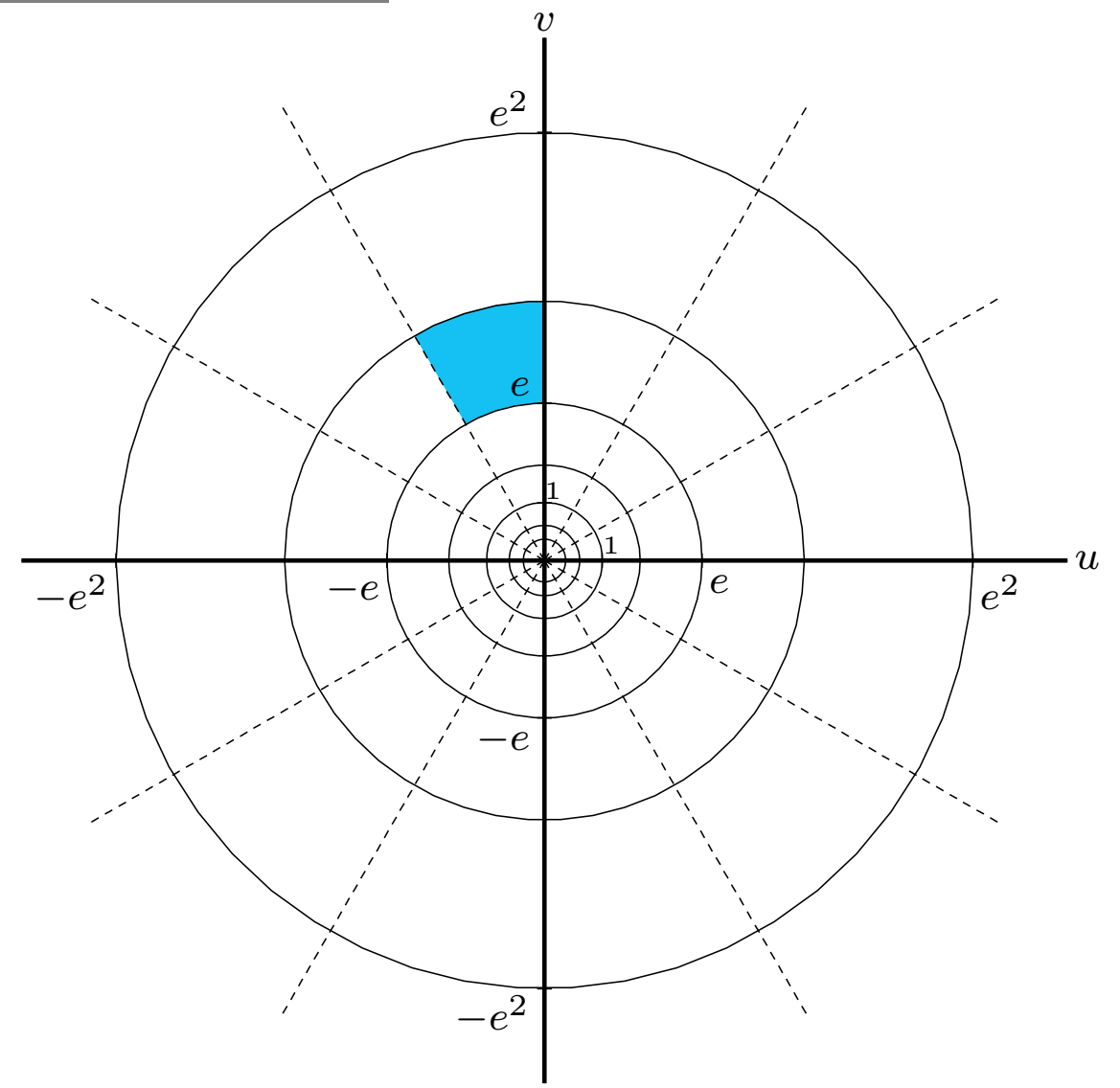
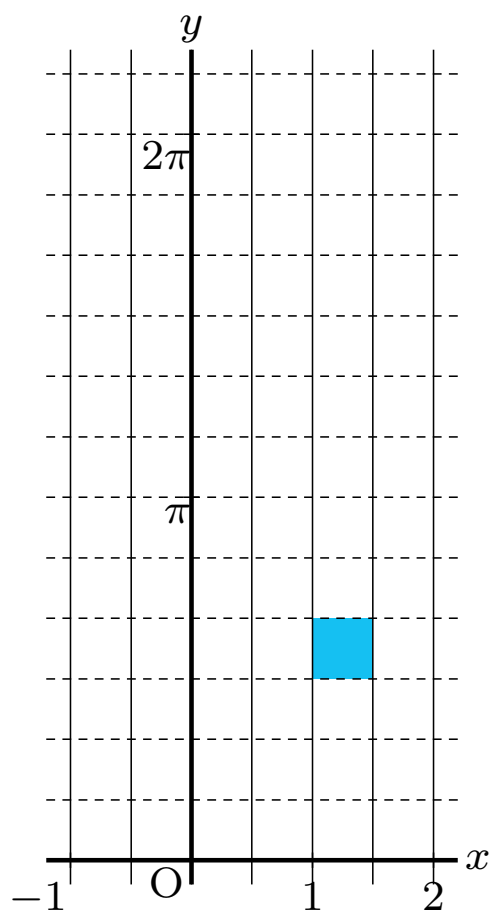

End

$w = e^z$ z -plane \longrightarrow w -plane

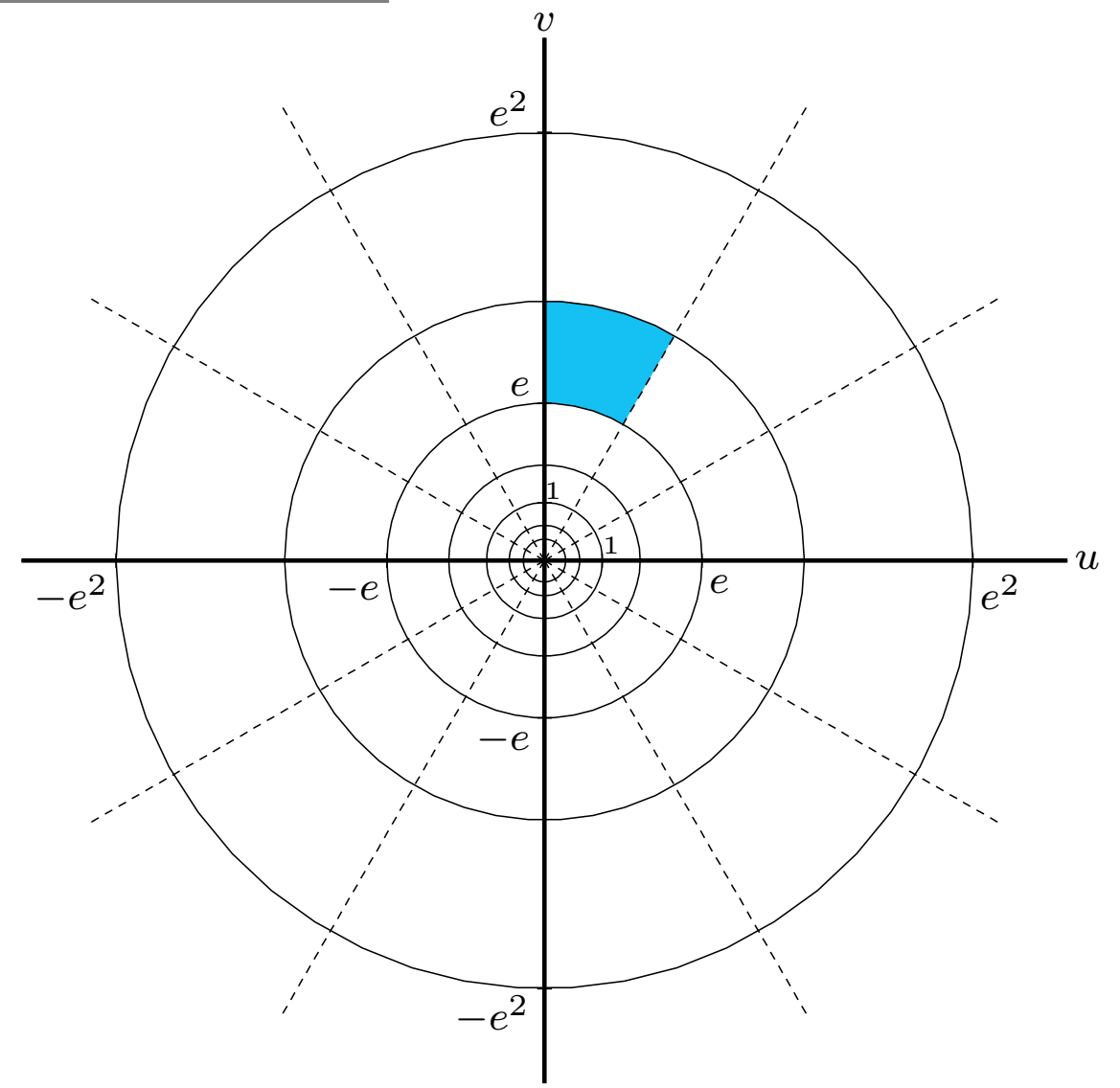
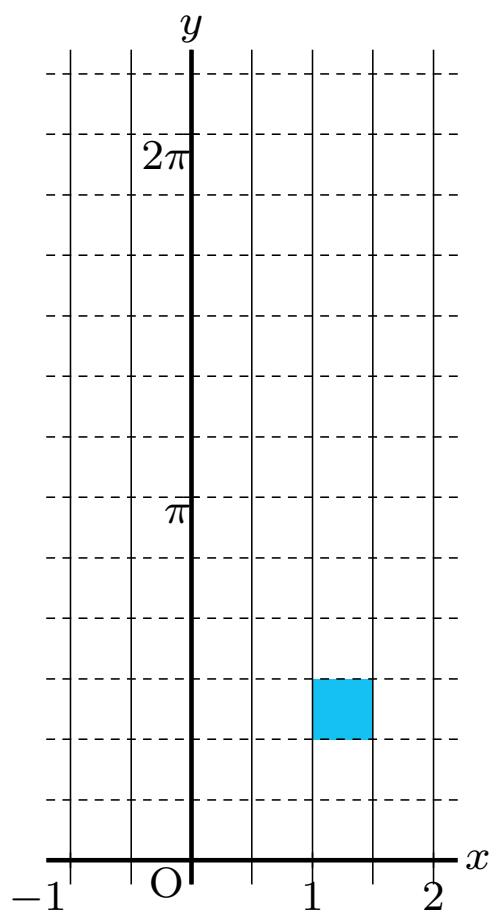

End

$w = e^z$ z -plane \longrightarrow w -plane

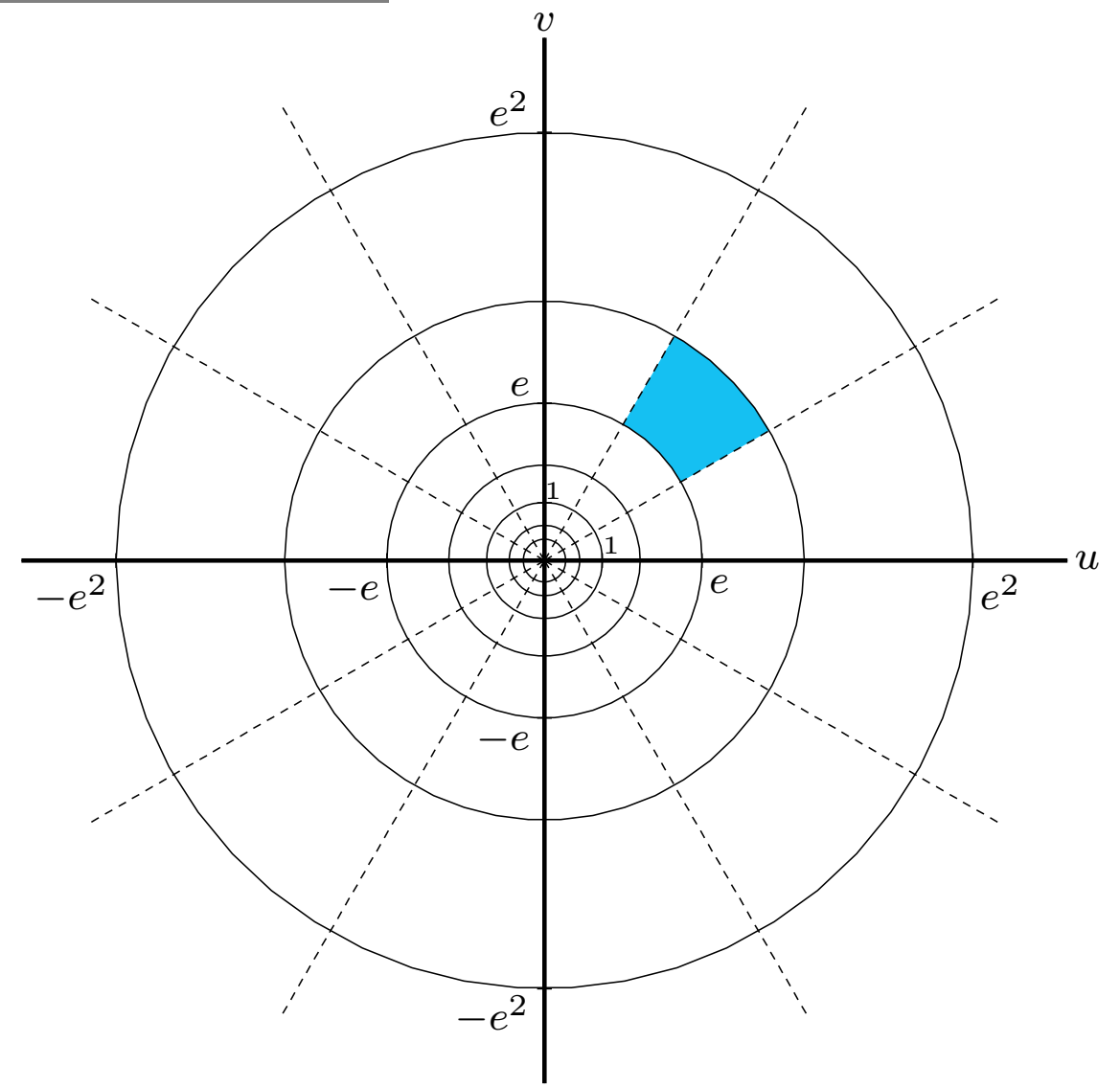
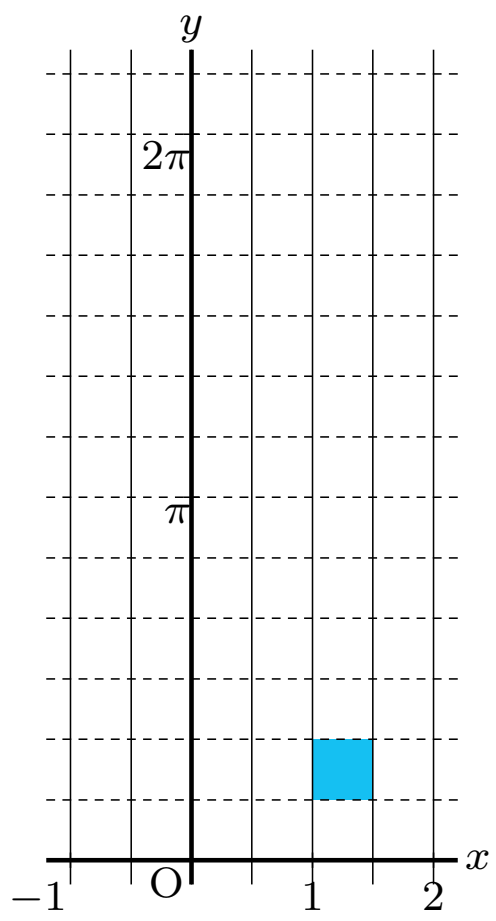

End

$w = e^z$ z -plane \longrightarrow w -plane

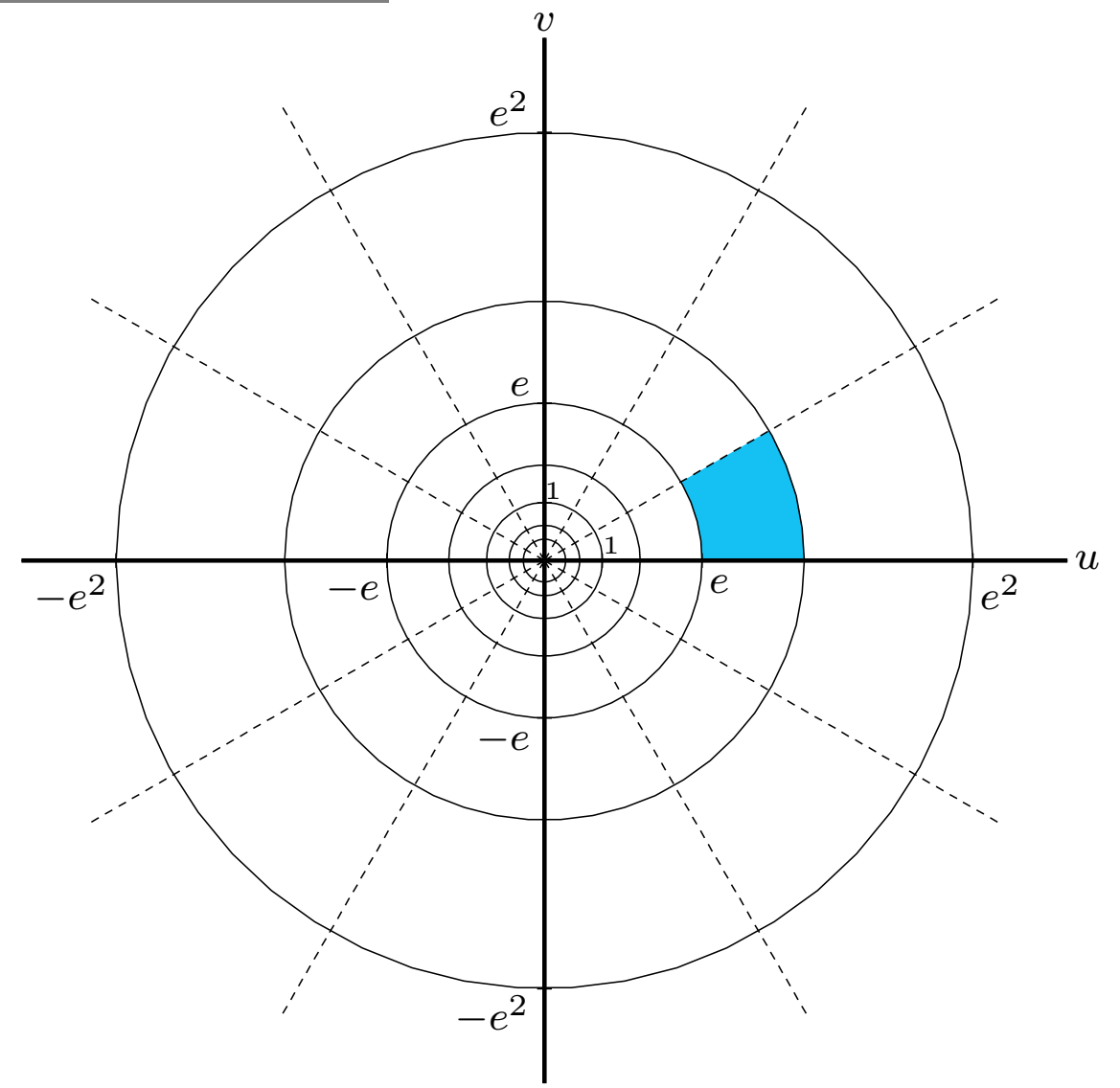
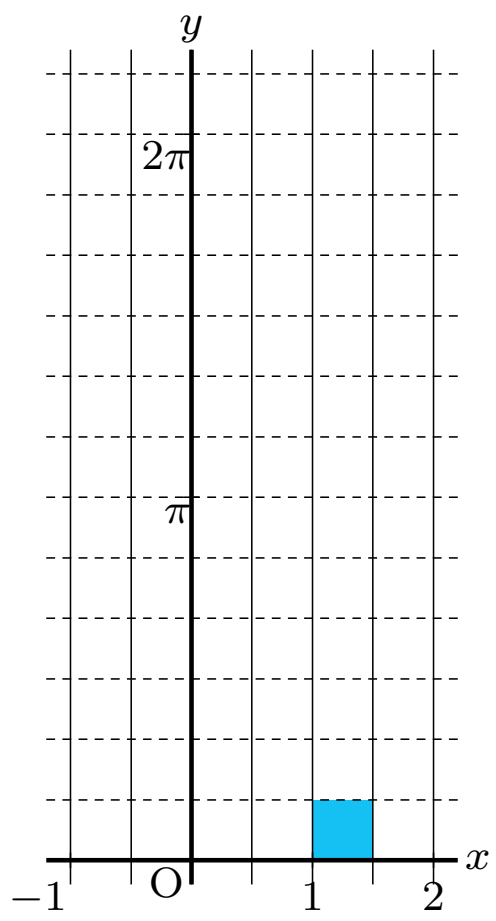

End

$w = e^z$ z -plane \longrightarrow w -plane

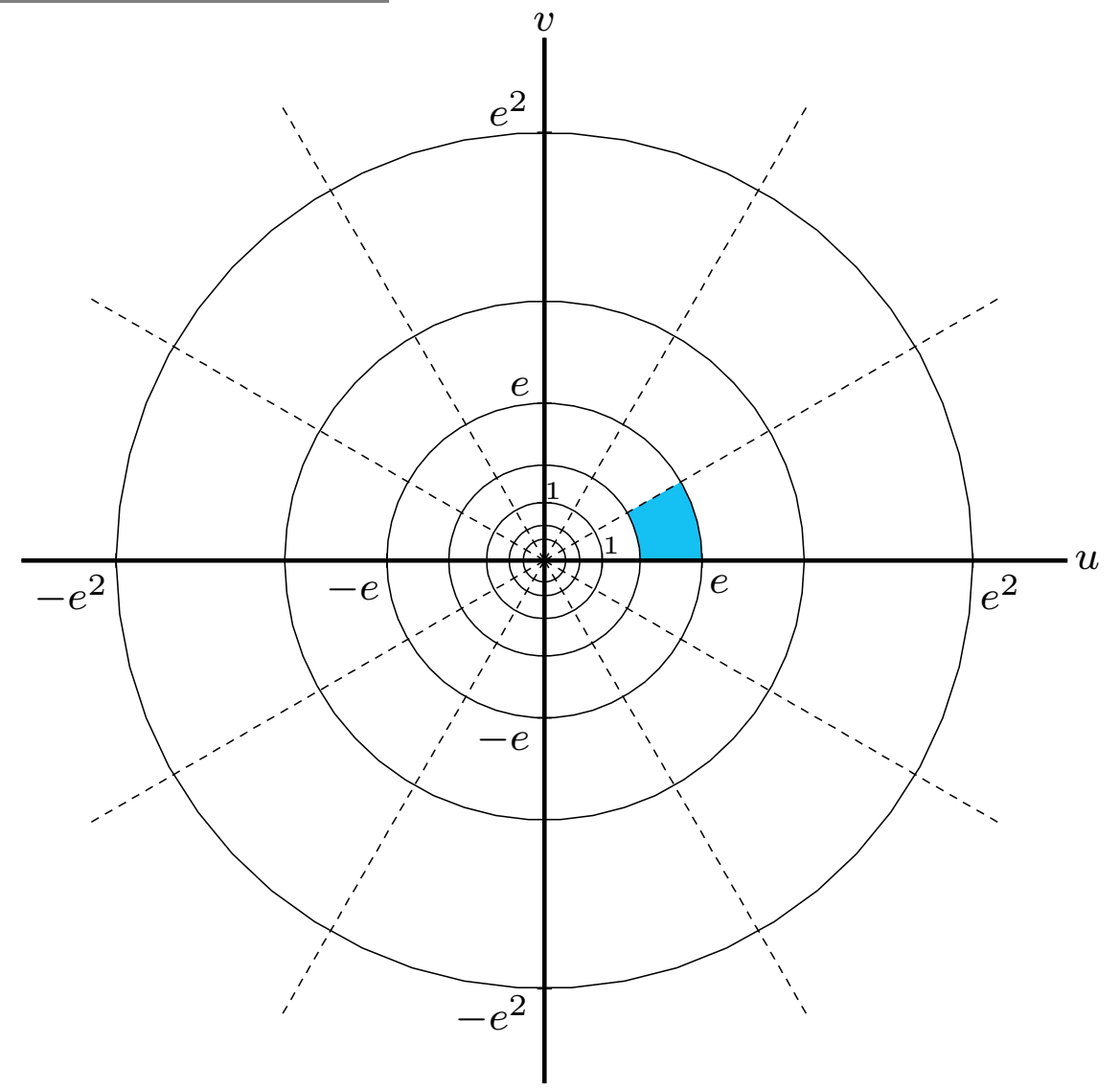
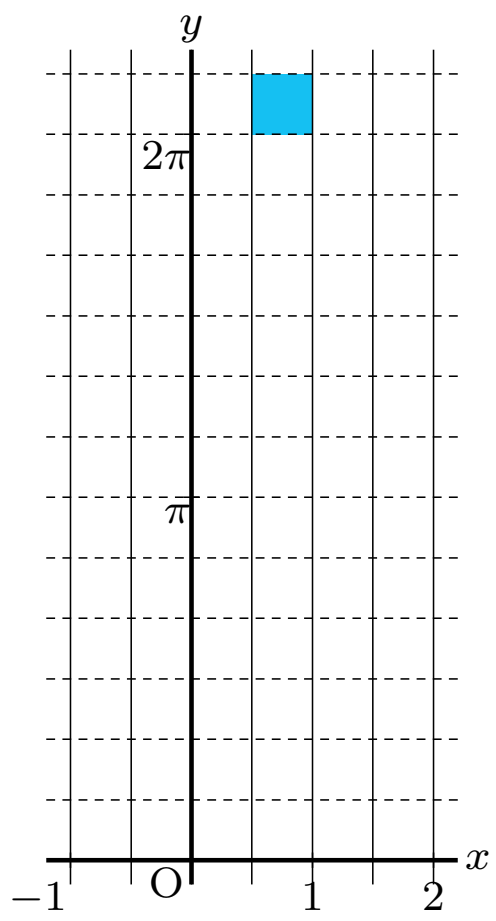

End

$w = e^z$ z -plane \longrightarrow w -plane

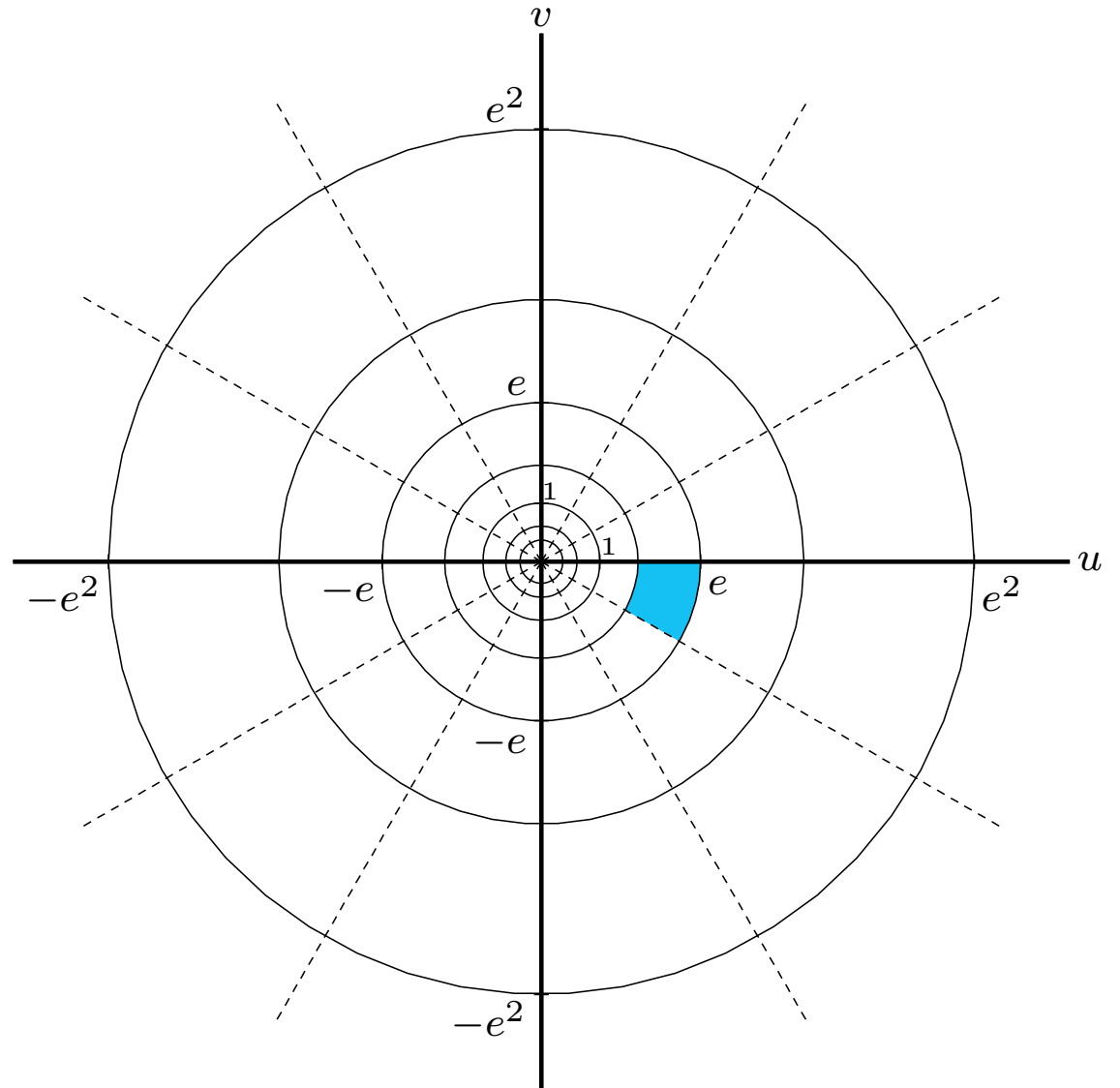
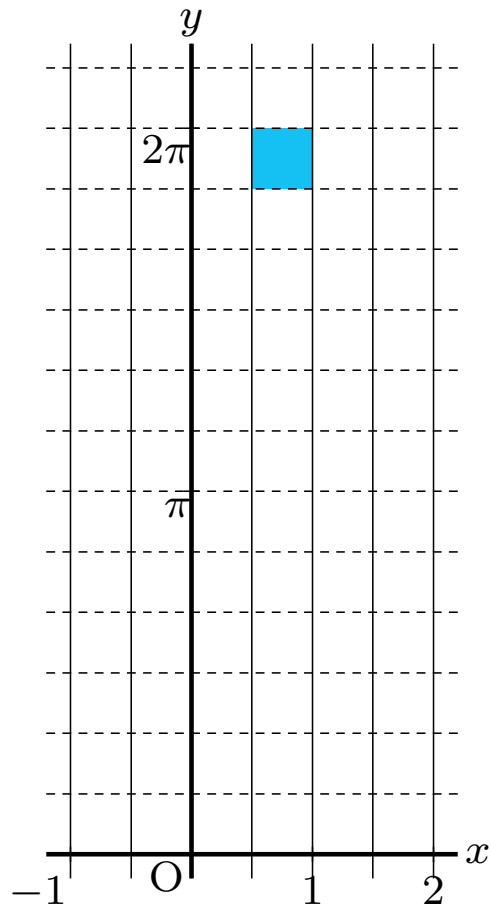

End

$w = e^z$ z -plane \longrightarrow w -plane

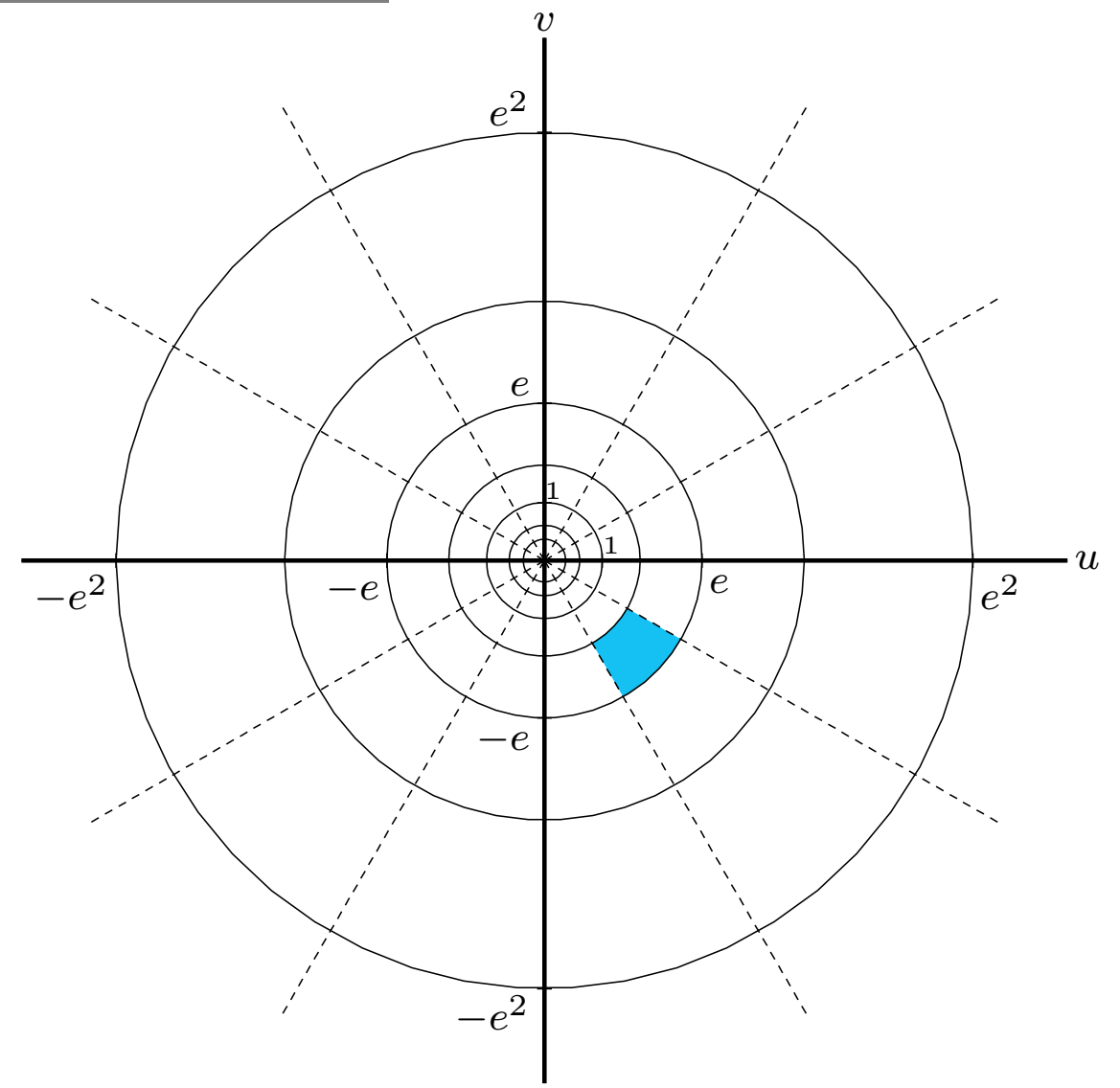
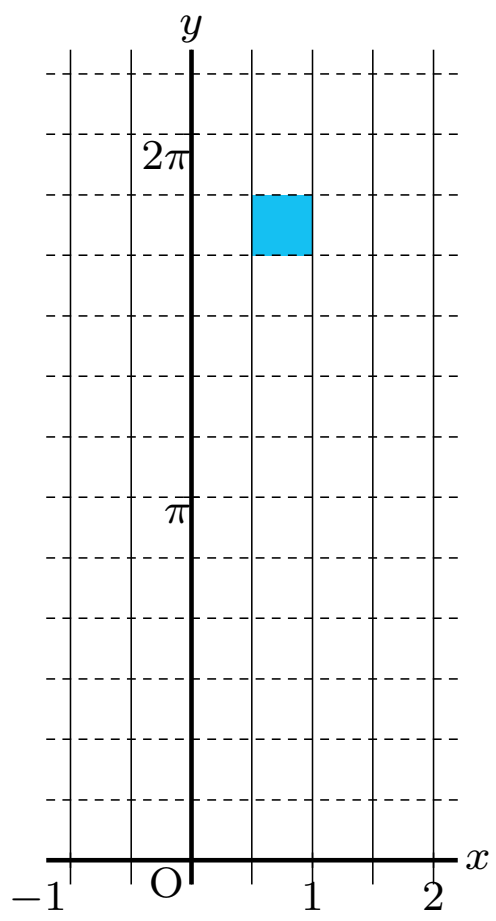

End

$w = e^z$ z -plane \longrightarrow w -plane

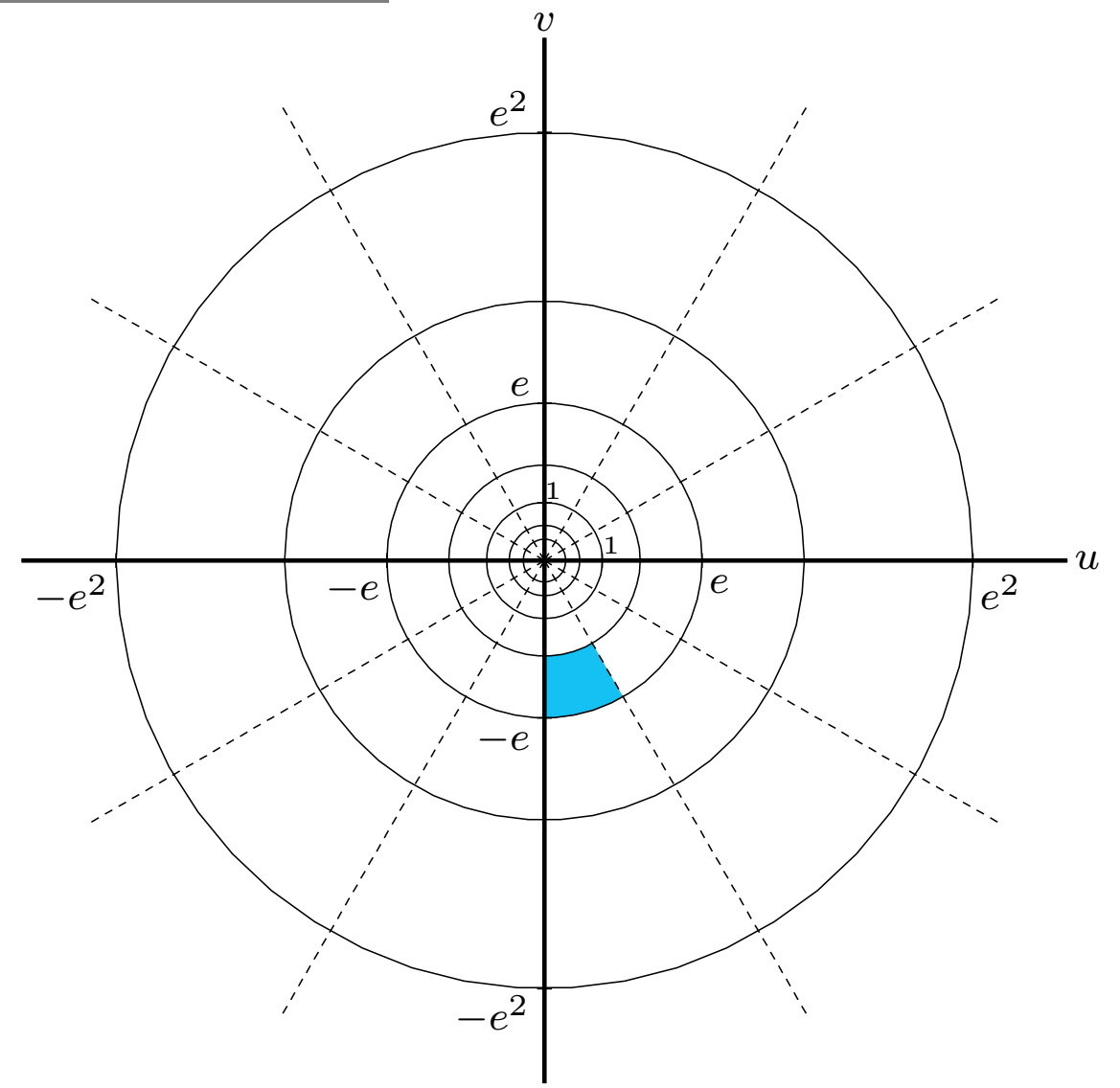
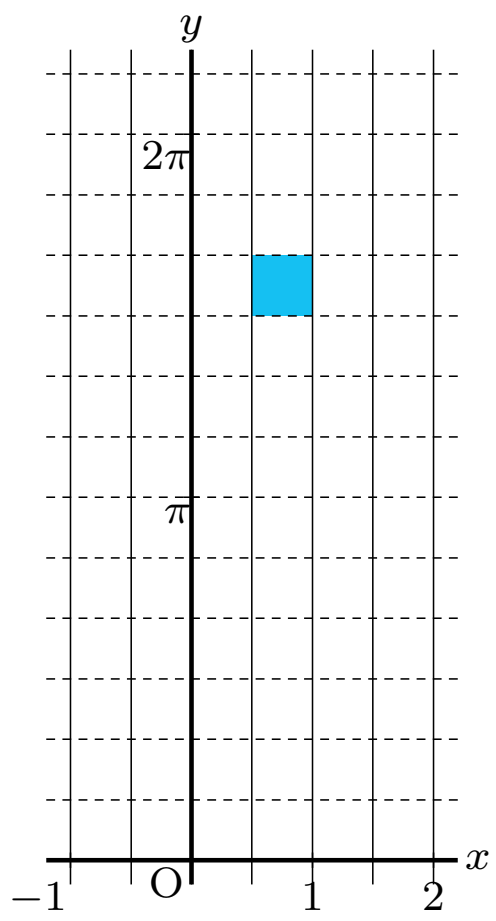

End

$w = e^z$ z -plane \longrightarrow w -plane

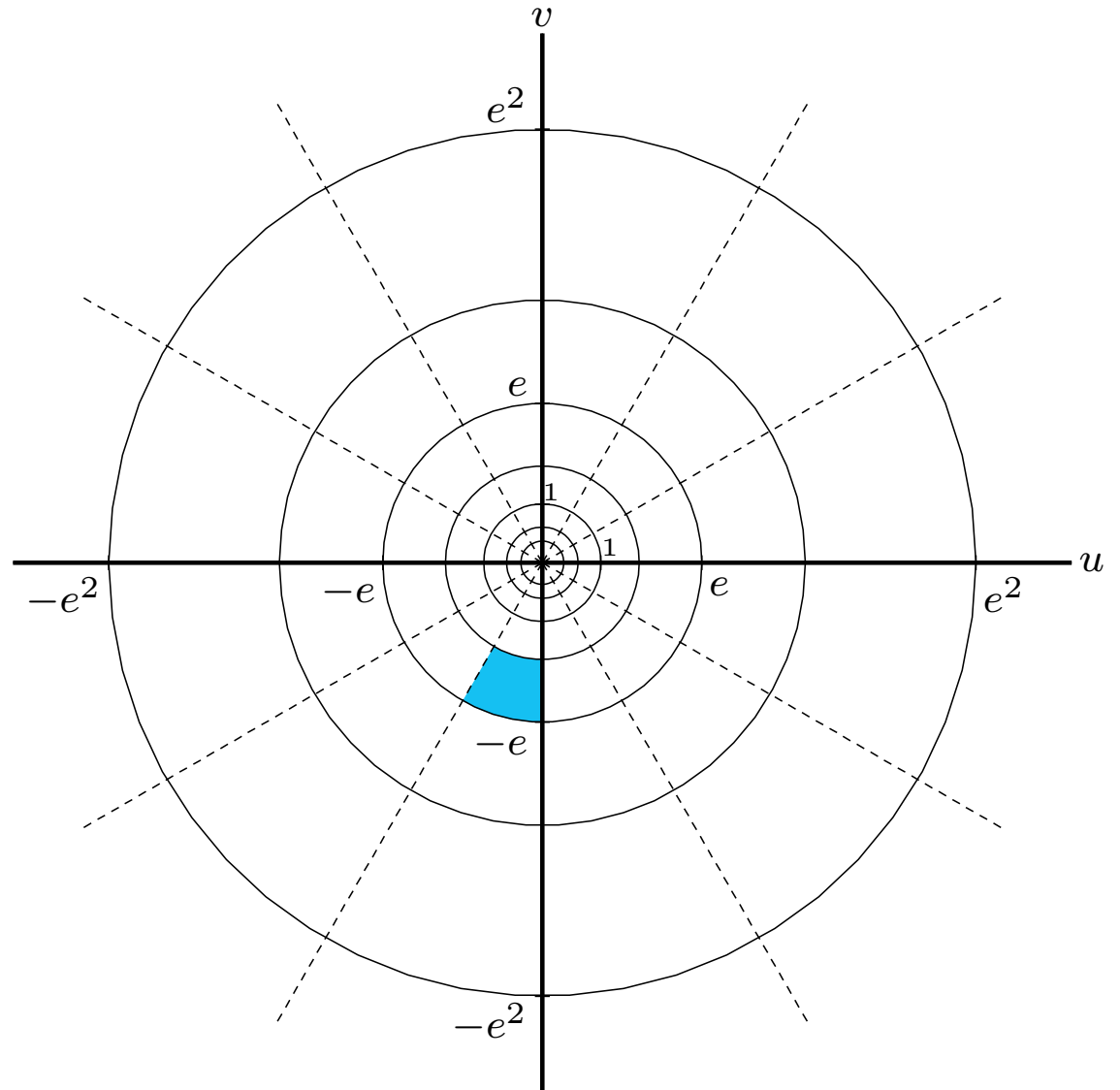
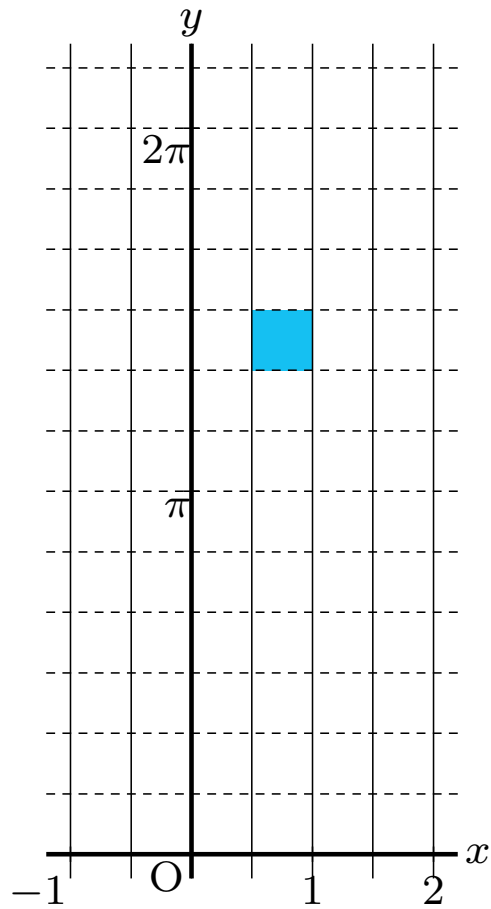

End

$w = e^z$ z -plane \longrightarrow w -plane

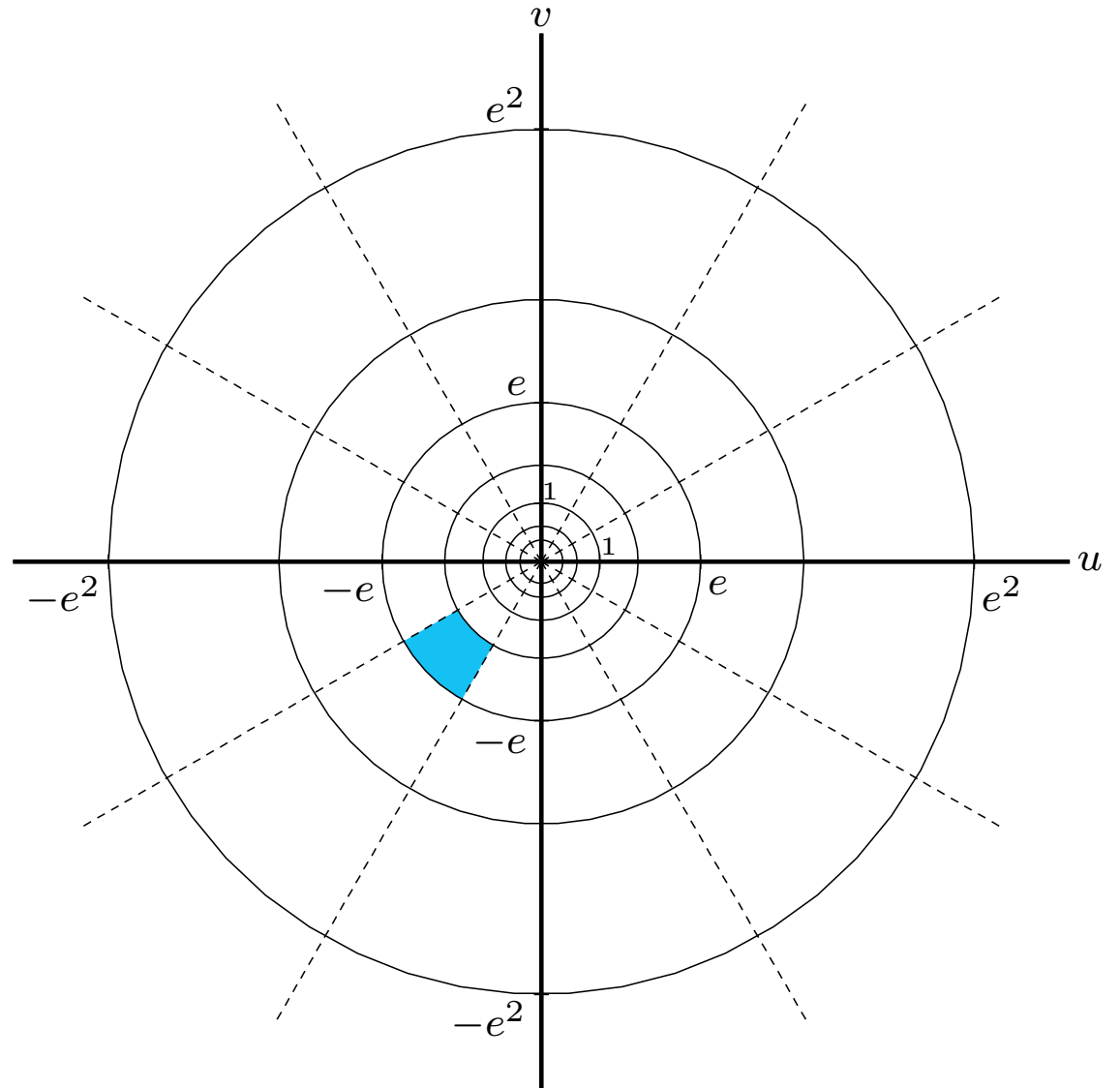
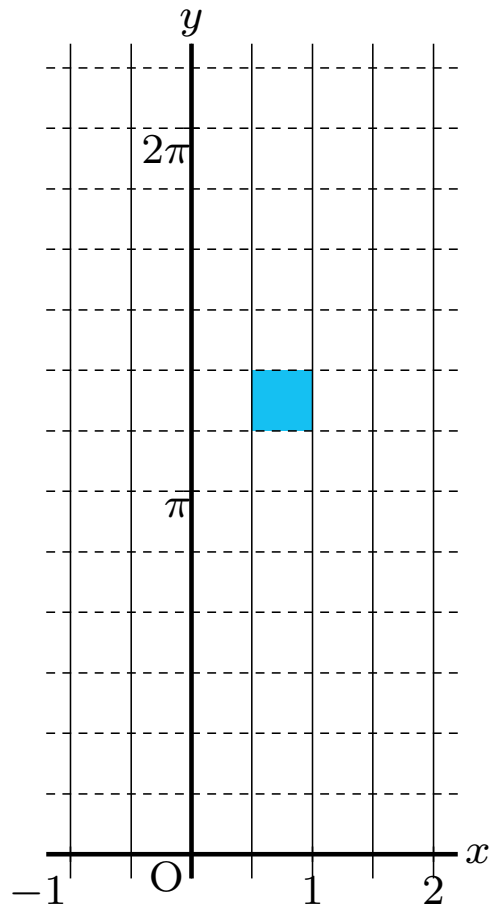

End

$w = e^z$ z -plane \longrightarrow w -plane

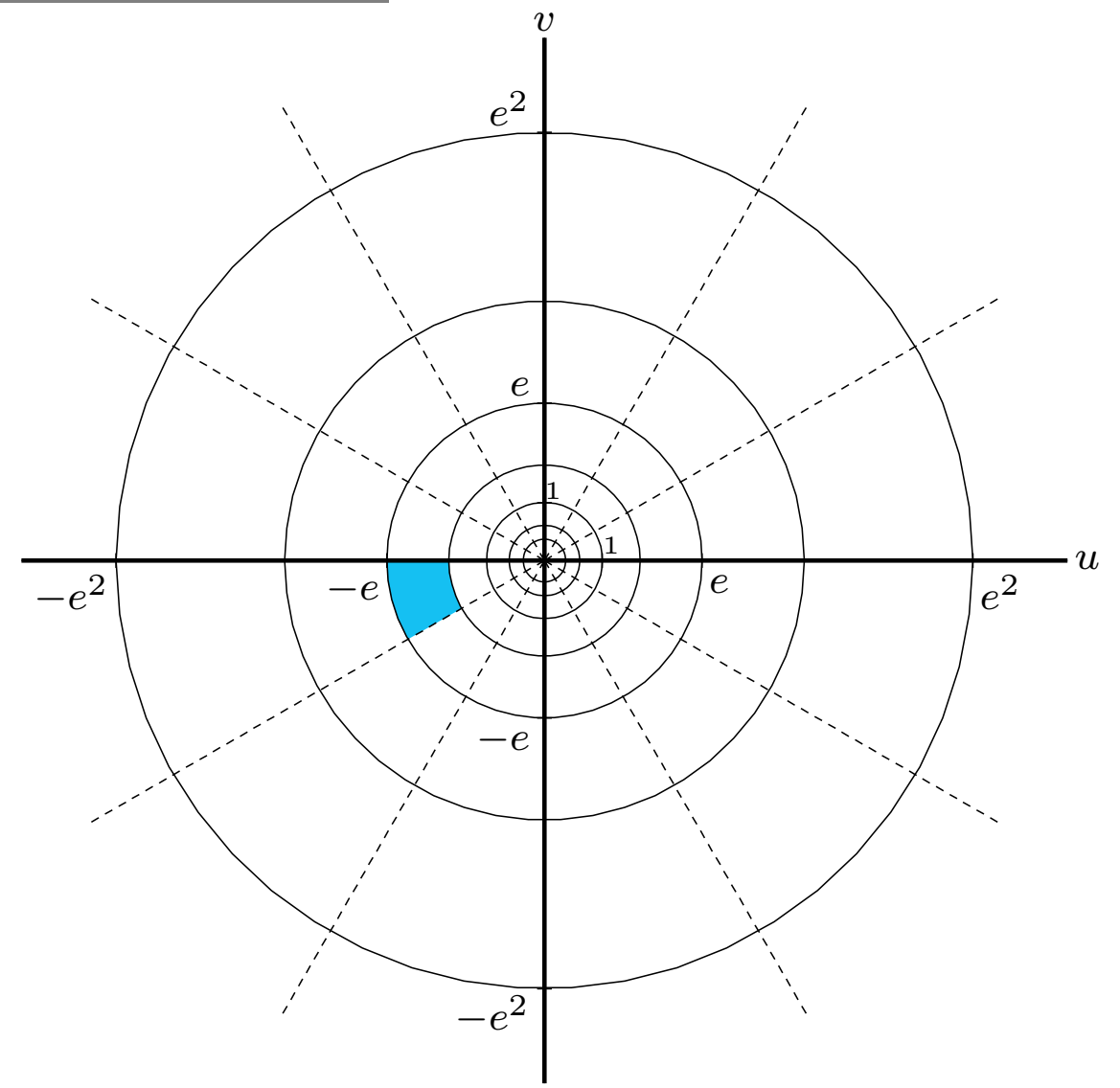
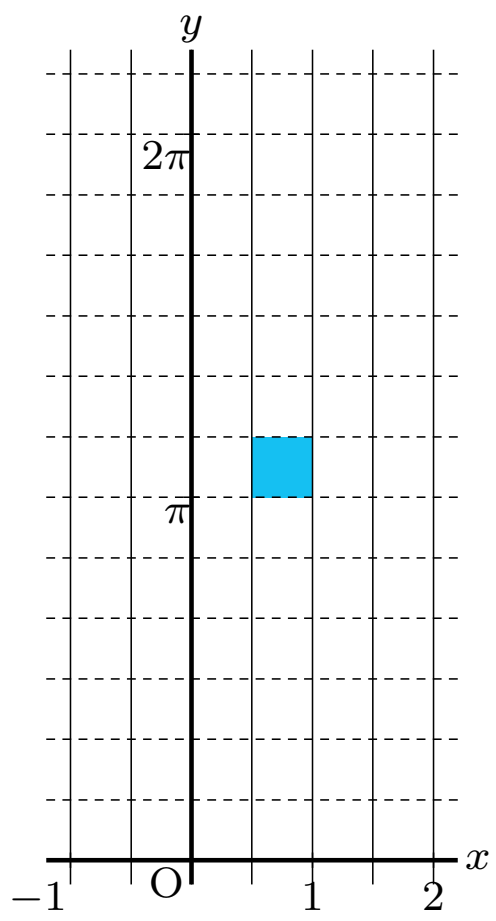

End

$w = e^z$ z -plane \longrightarrow w -plane

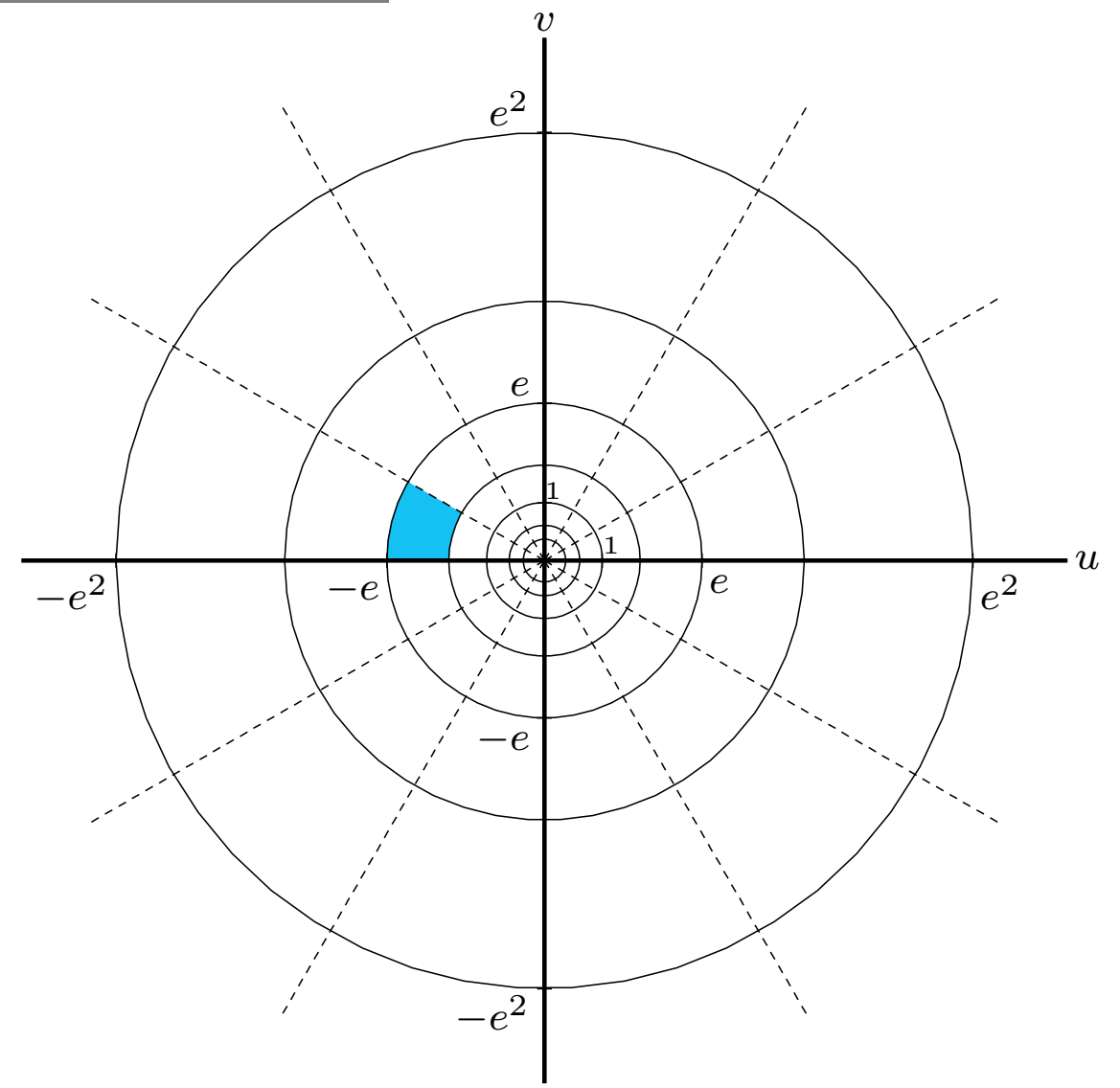
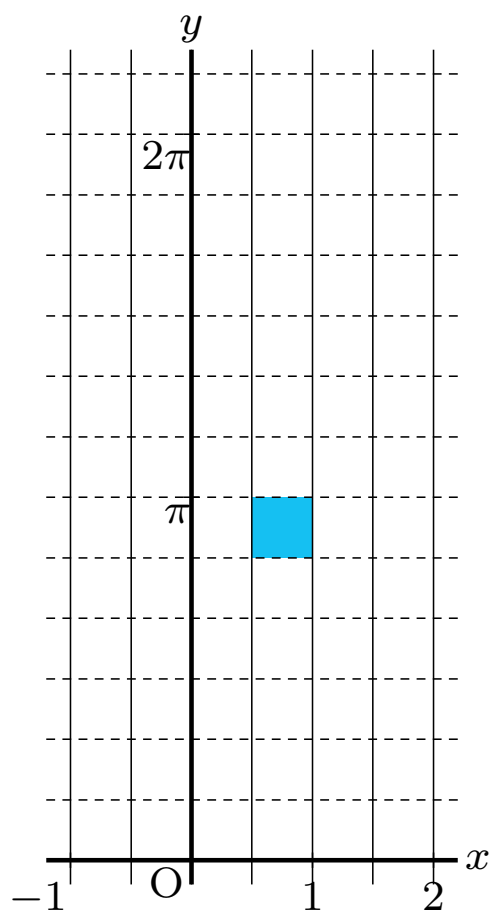

End

$w = e^z$ z -plane \longrightarrow w -plane

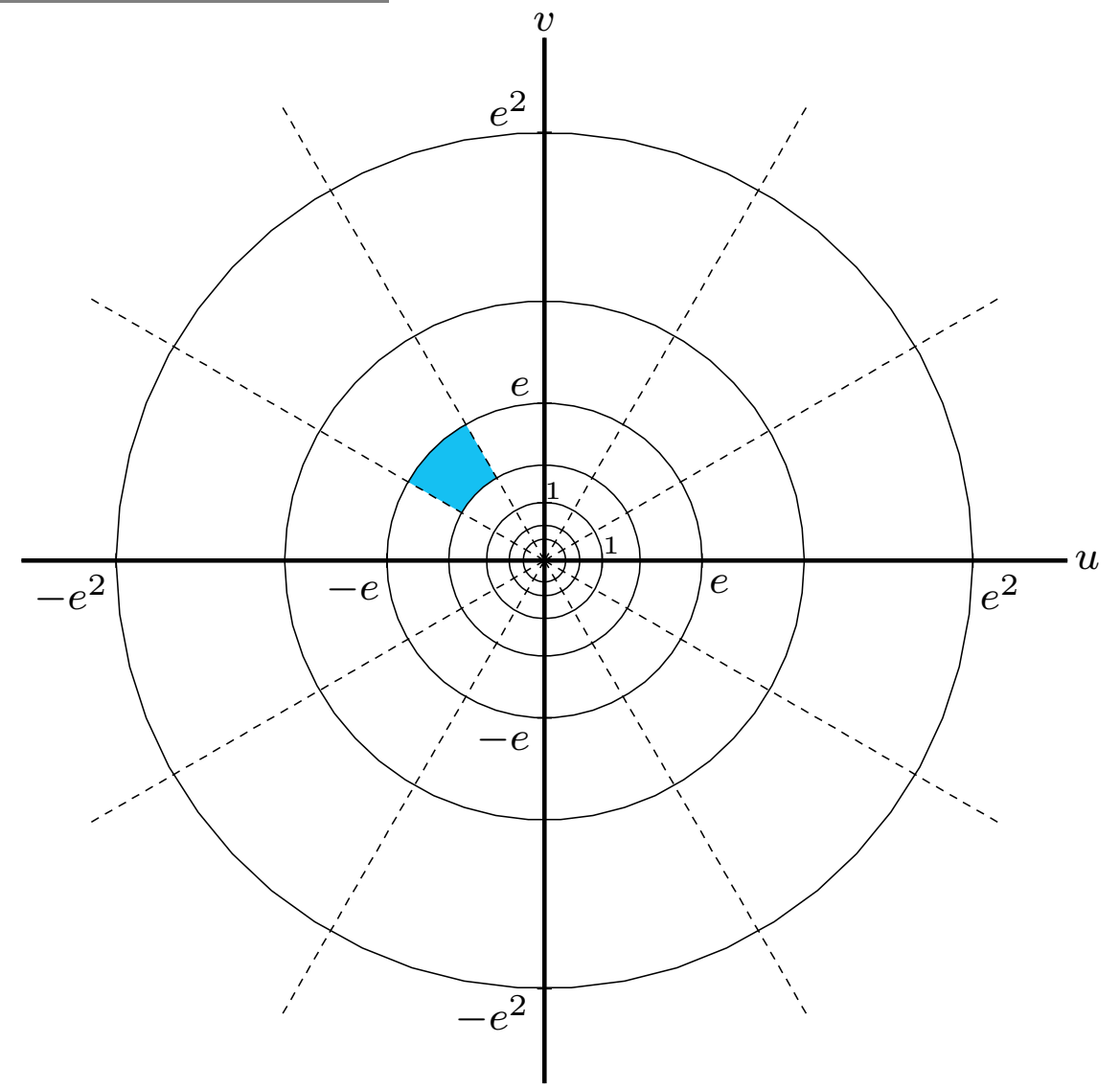
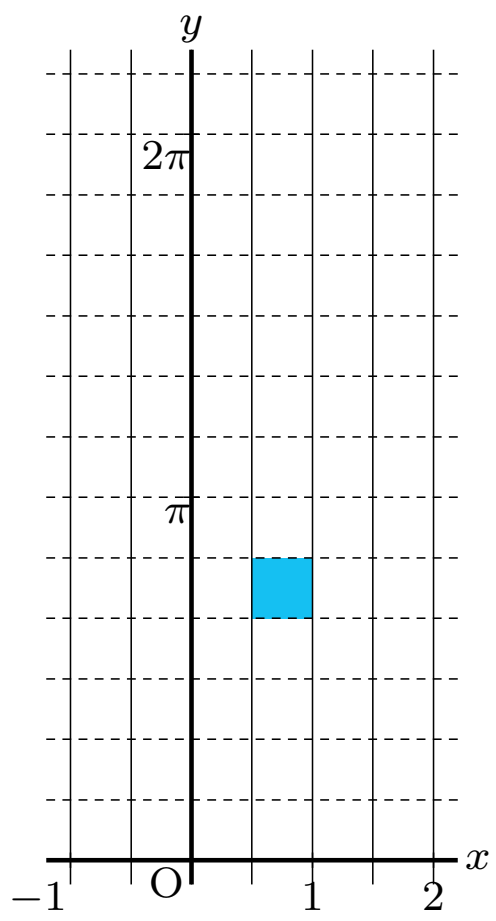

End

$w = e^z$ z -plane \longrightarrow w -plane

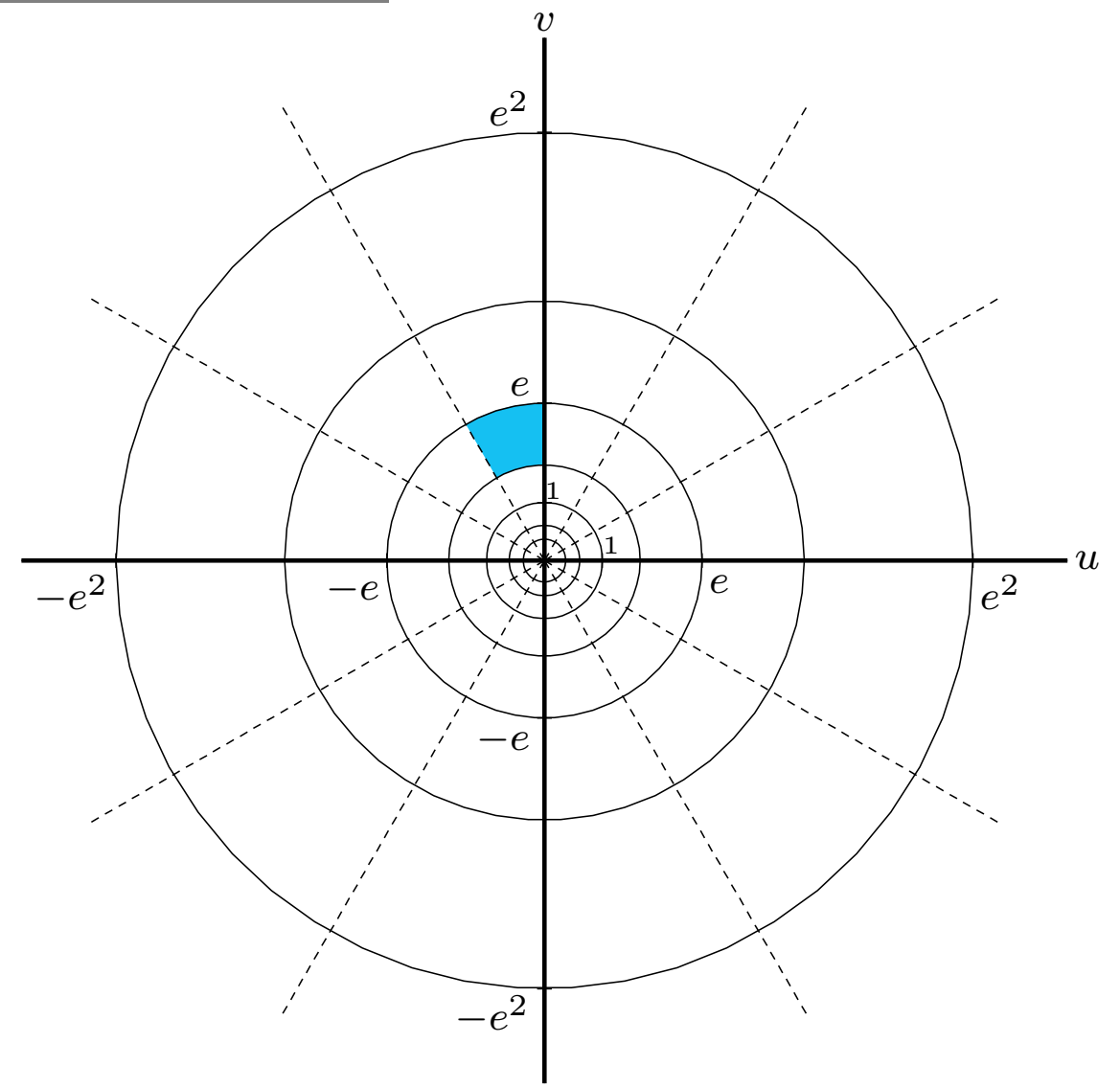
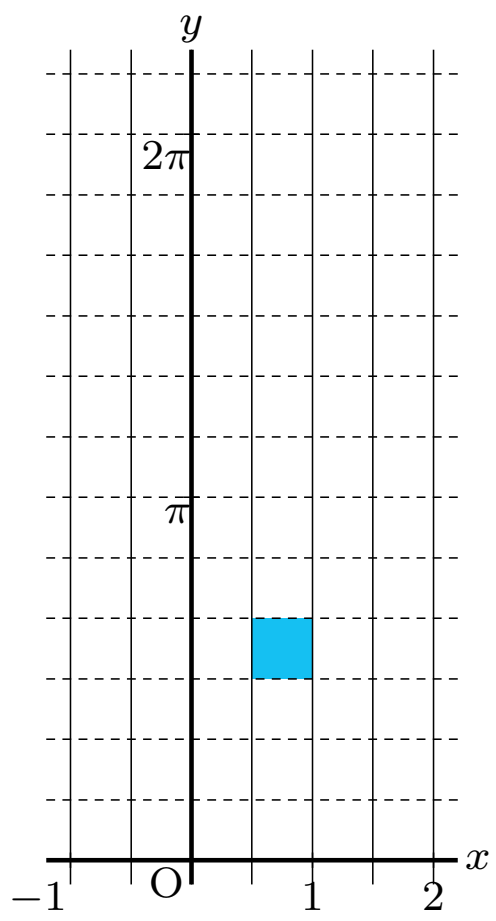

End

$w = e^z$ z -plane \longrightarrow w -plane

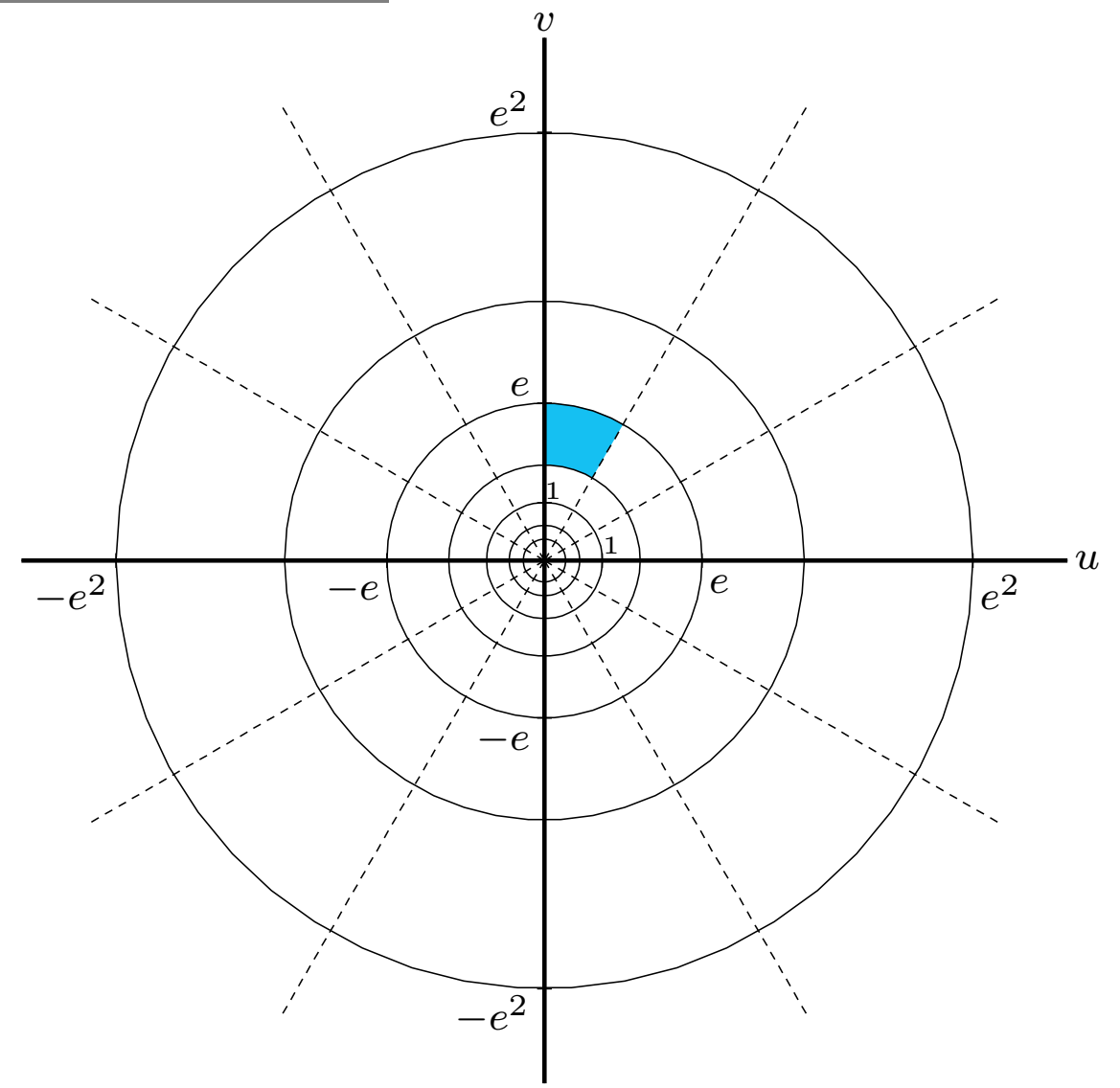
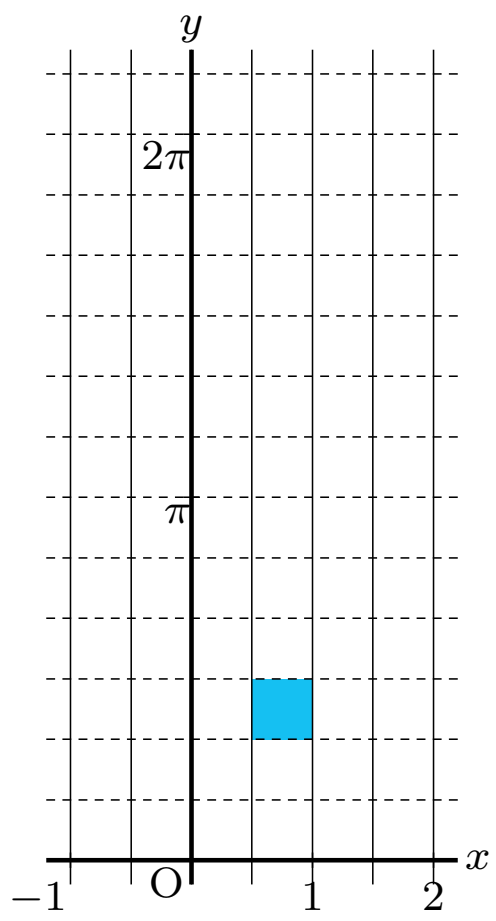

End

$w = e^z$ z -plane \longrightarrow w -plane

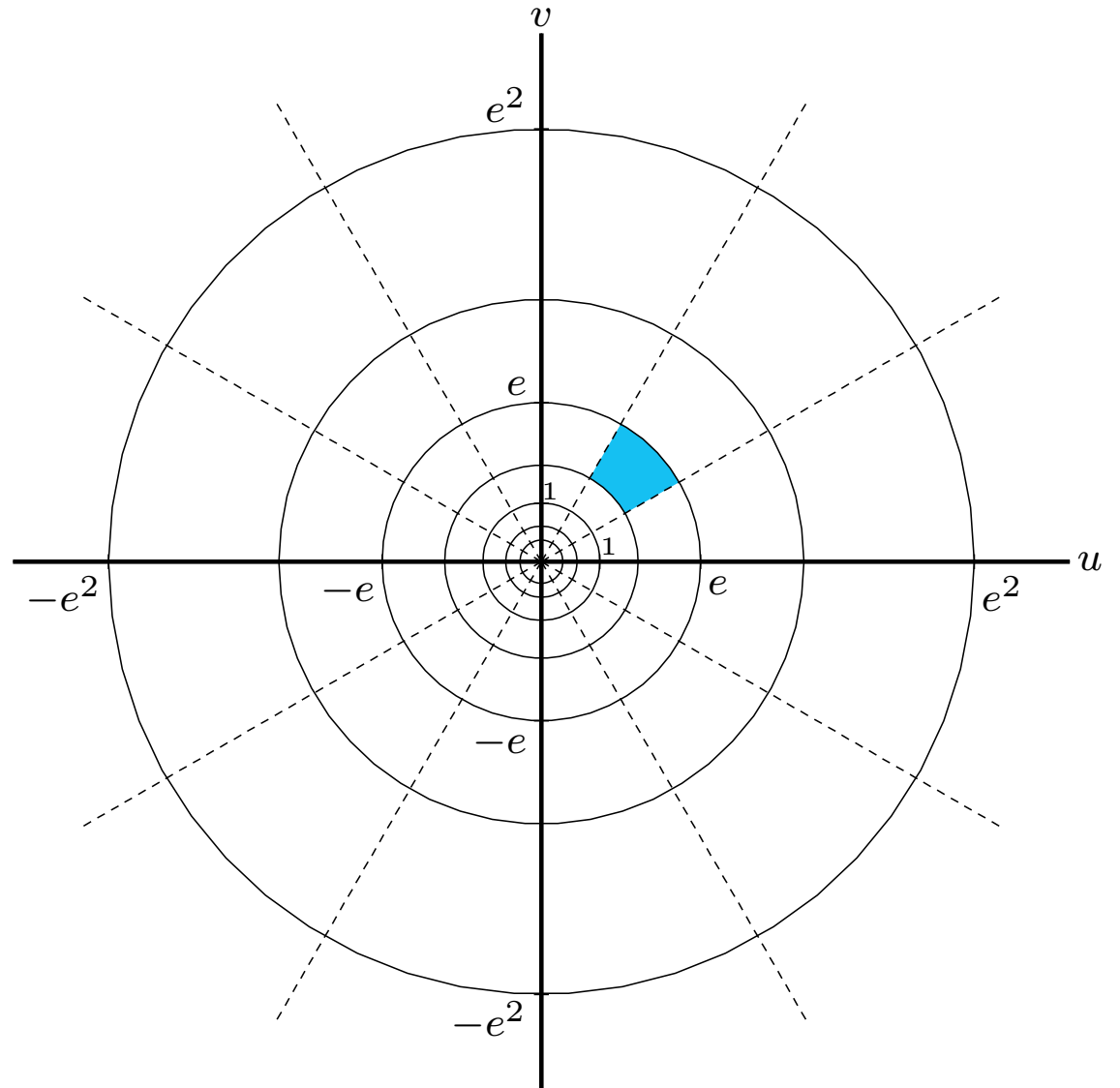
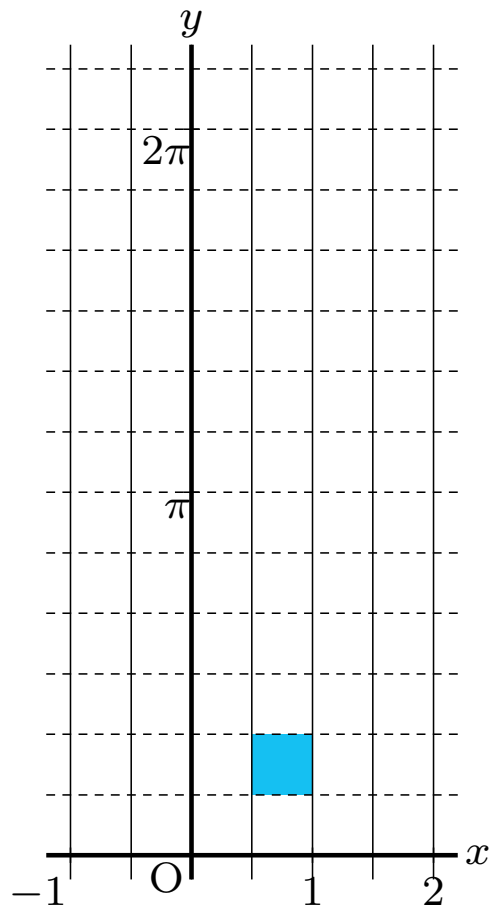

End

$w = e^z$ z -plane \longrightarrow w -plane

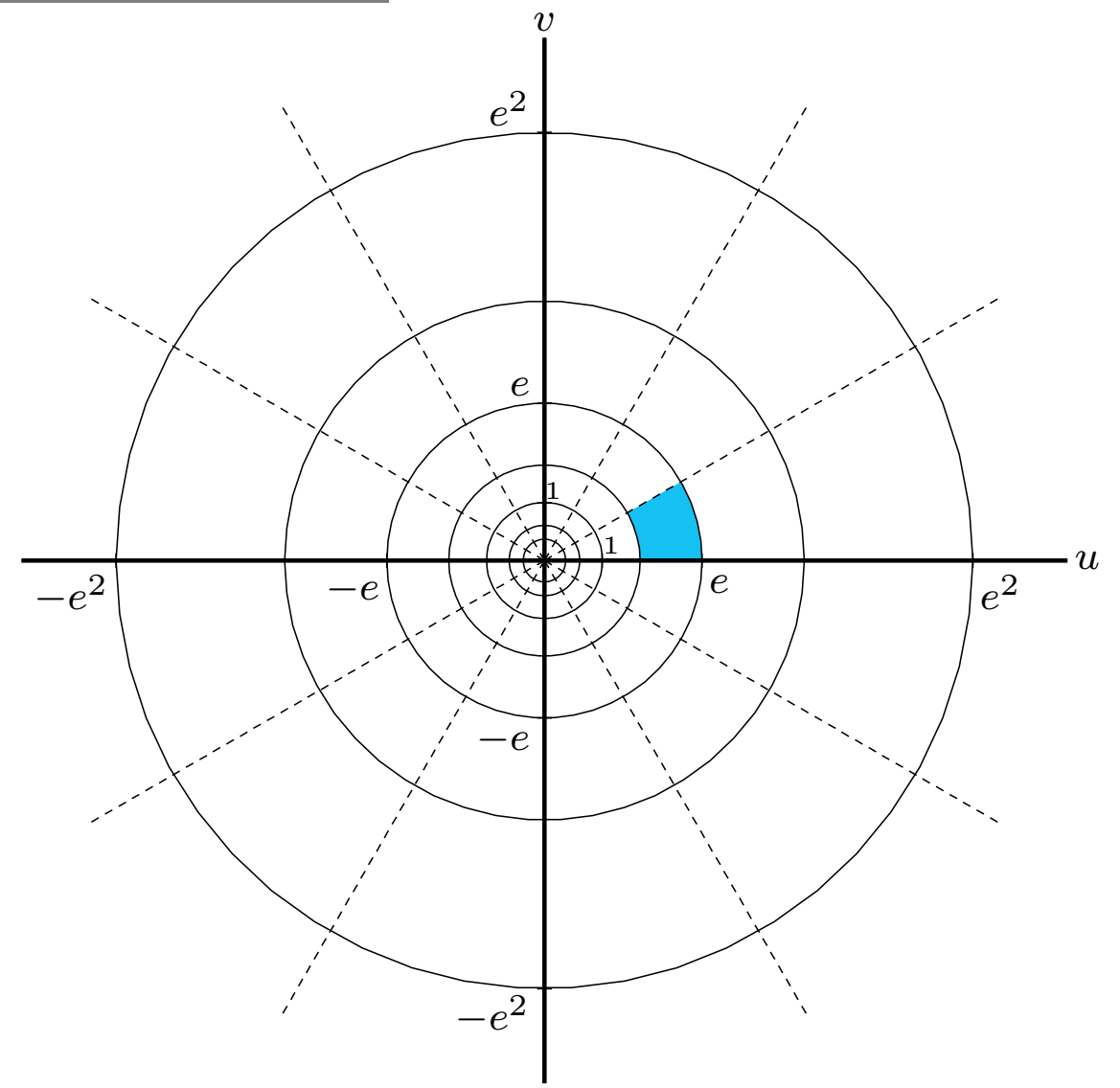
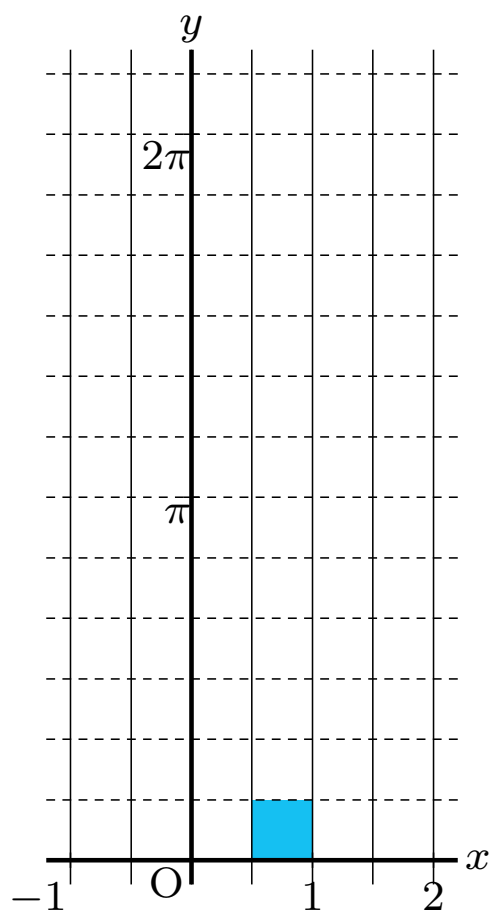

End

$w = e^z$ z -plane \longrightarrow w -plane

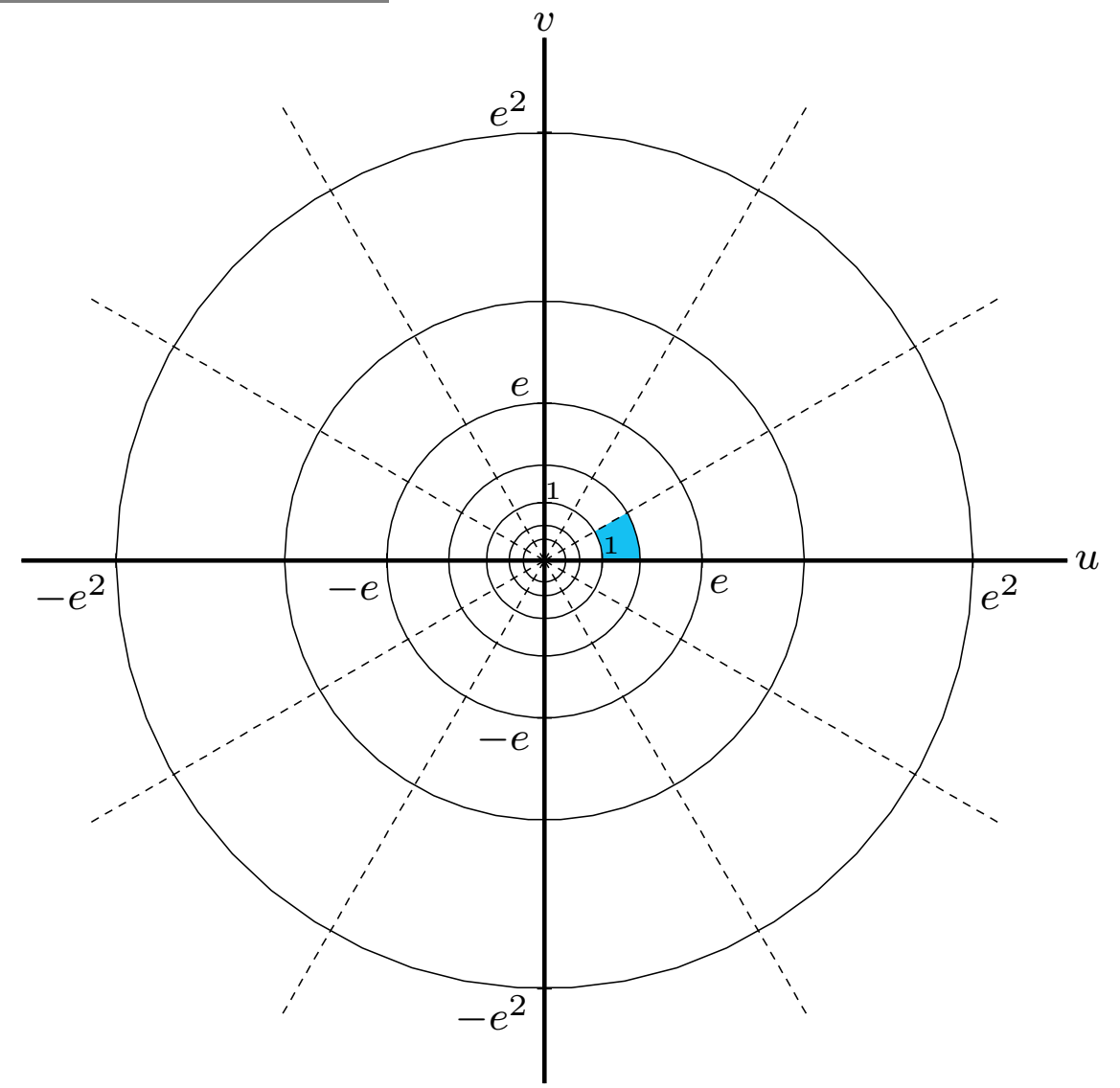
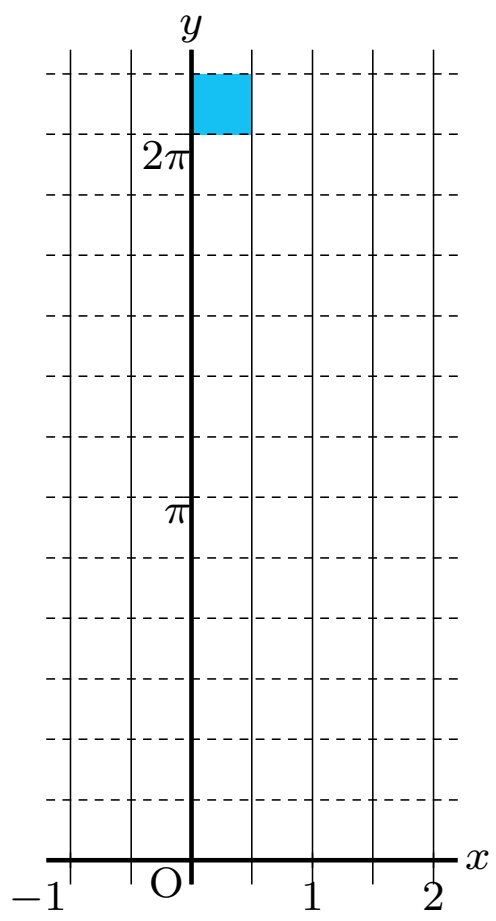

End

$w = e^z$ z -plane \longrightarrow w -plane

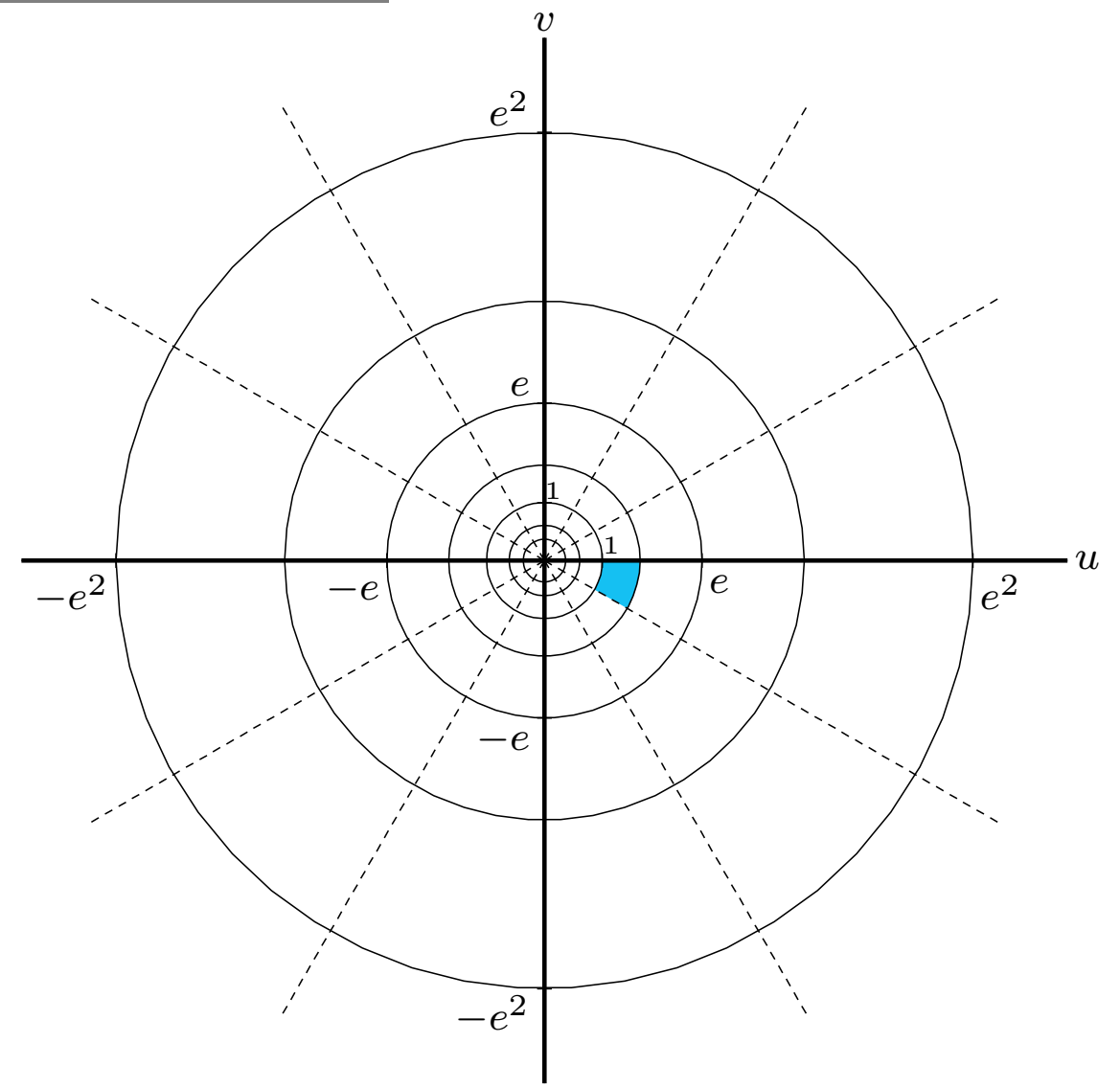
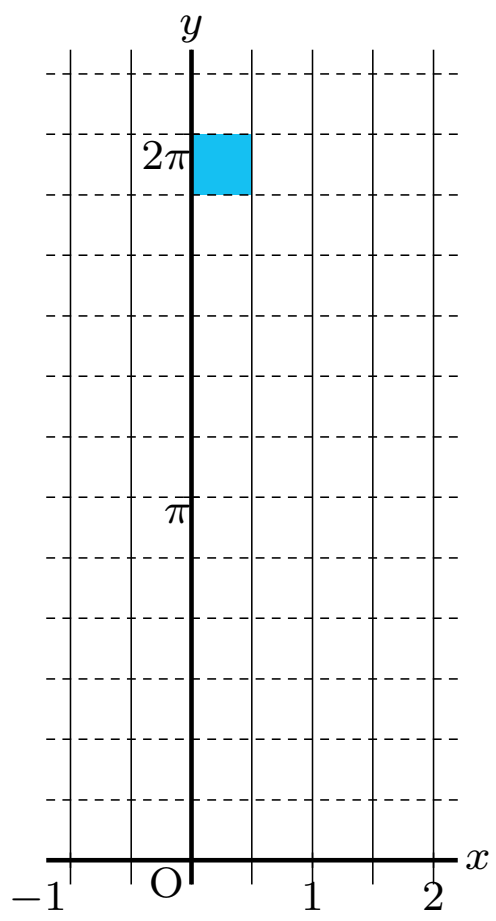

End

$w = e^z$ z -plane \longrightarrow w -plane

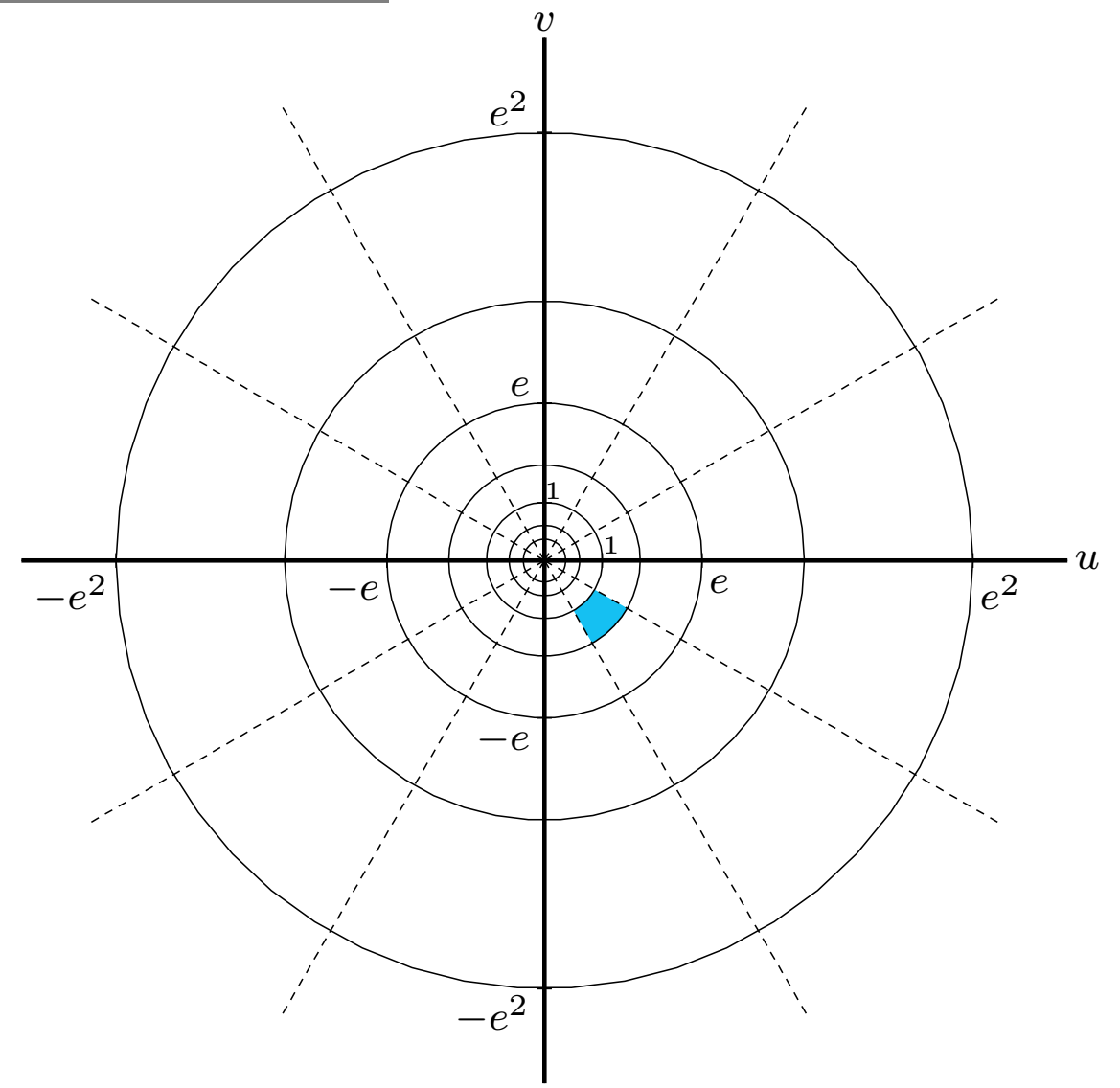
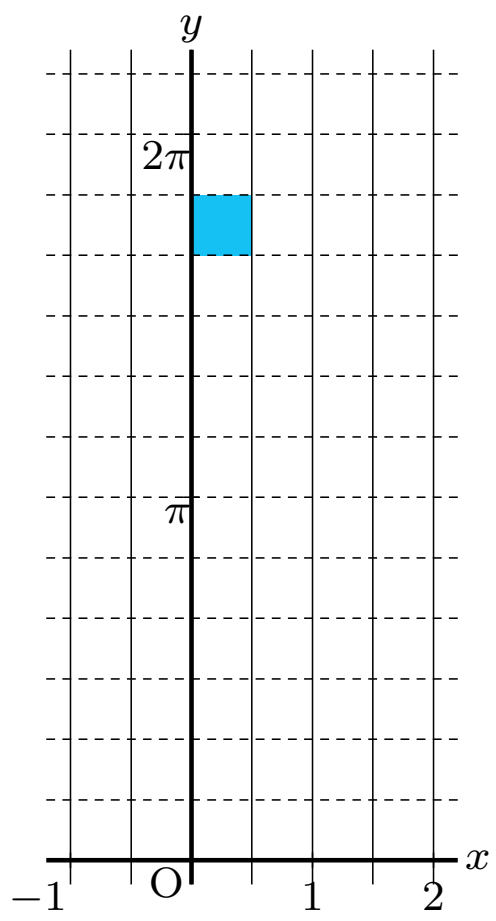

End

$w = e^z$ z -plane \longrightarrow w -plane

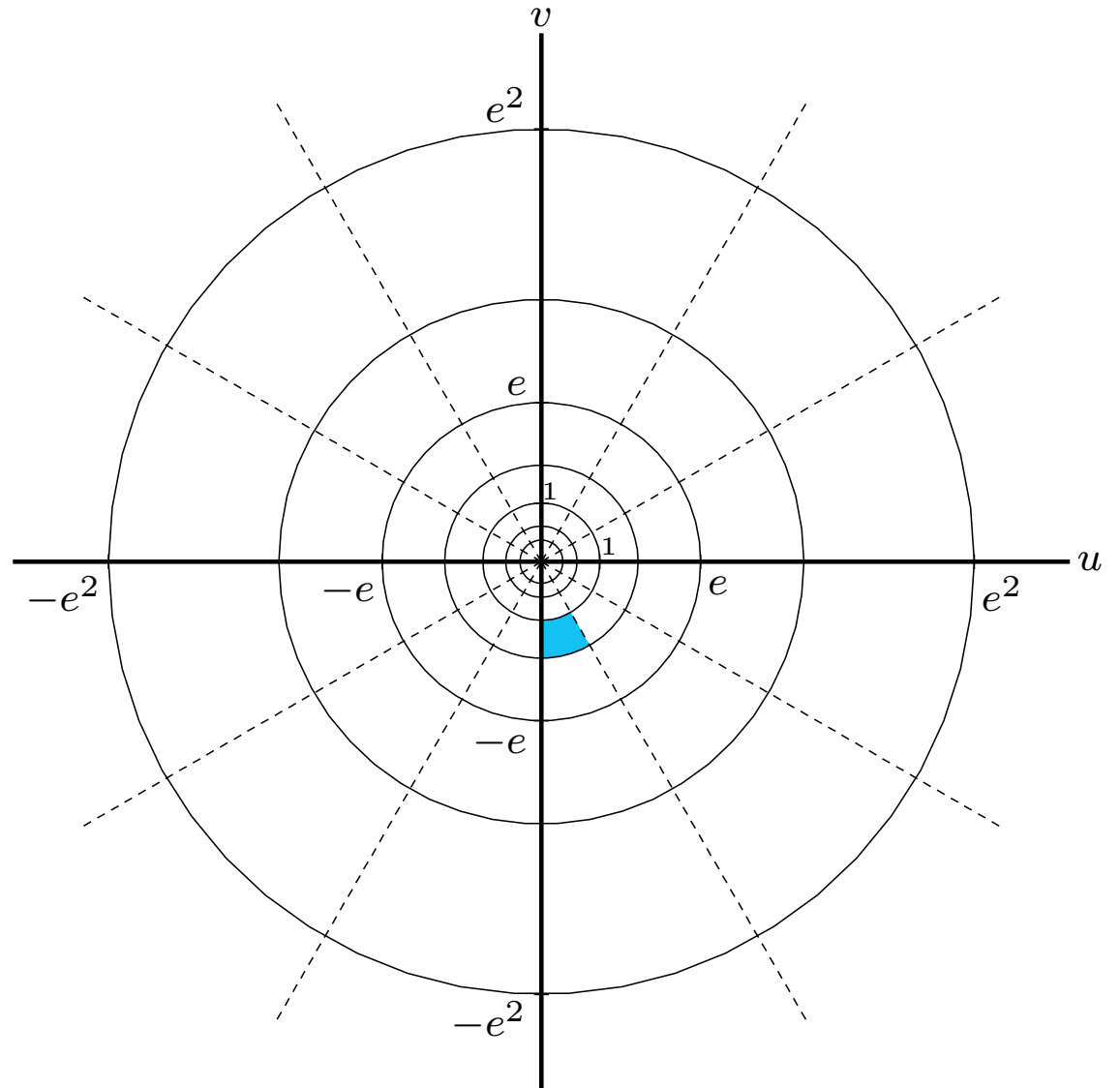
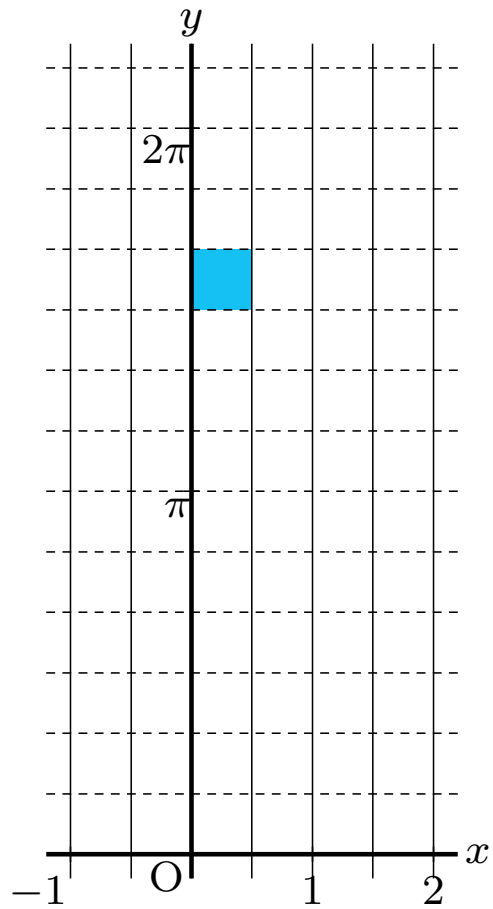

End

$w = e^z$ z -plane \longrightarrow w -plane

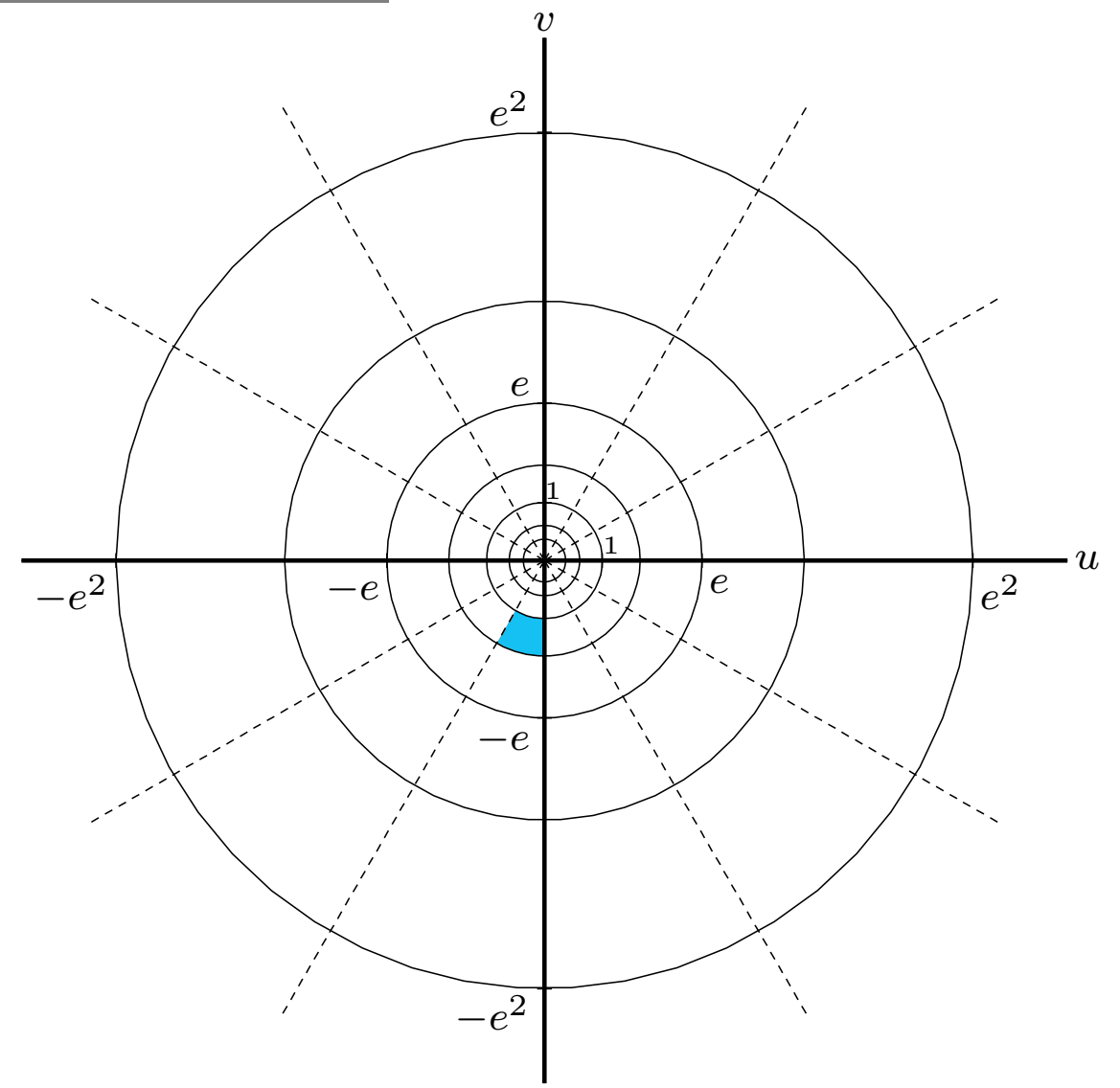
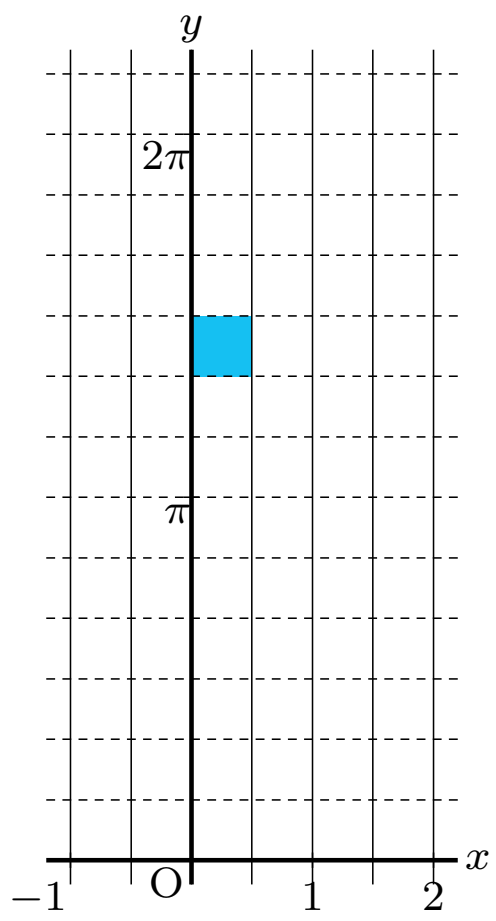

End

$w = e^z$ z -plane \longrightarrow w -plane

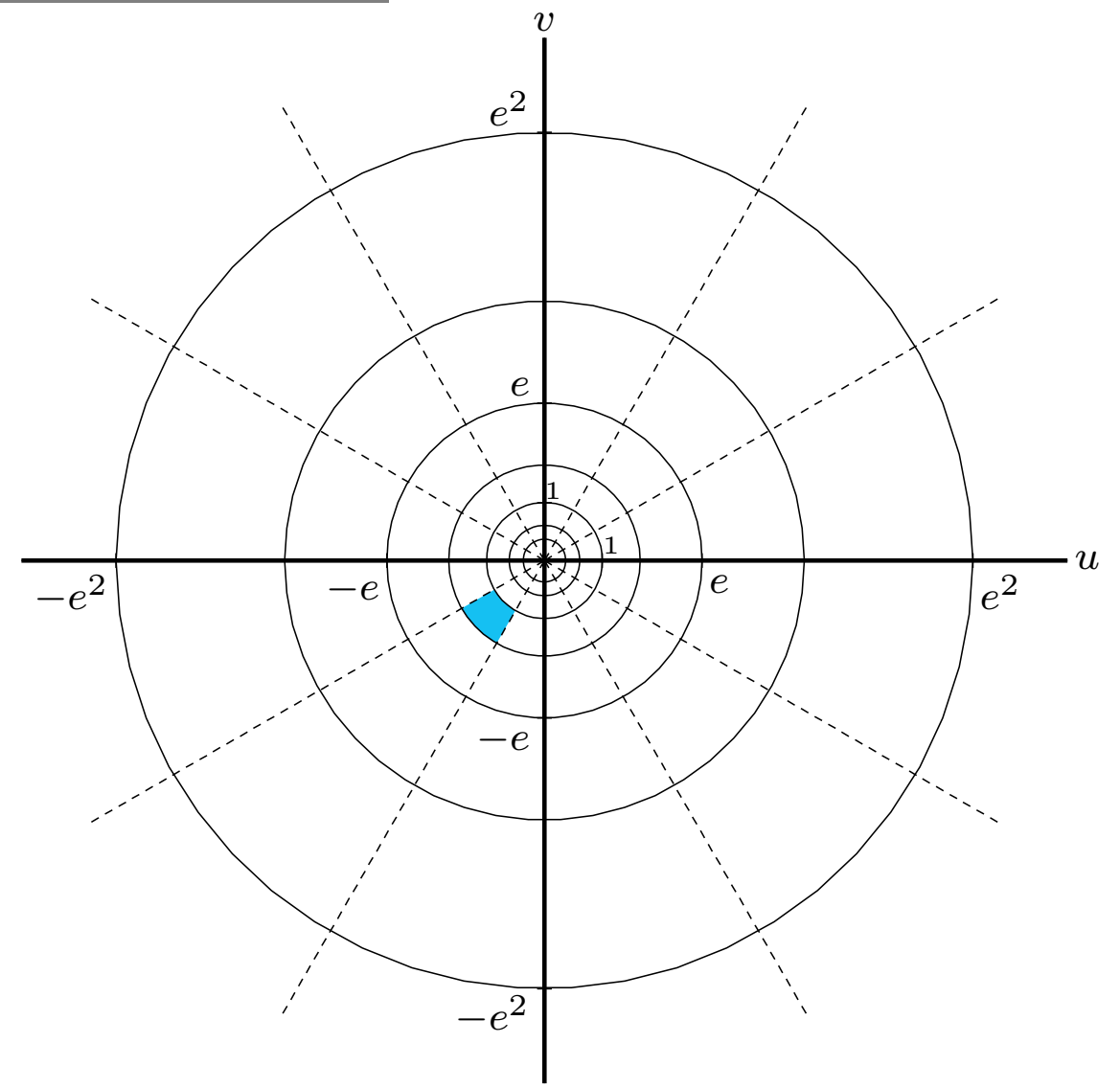
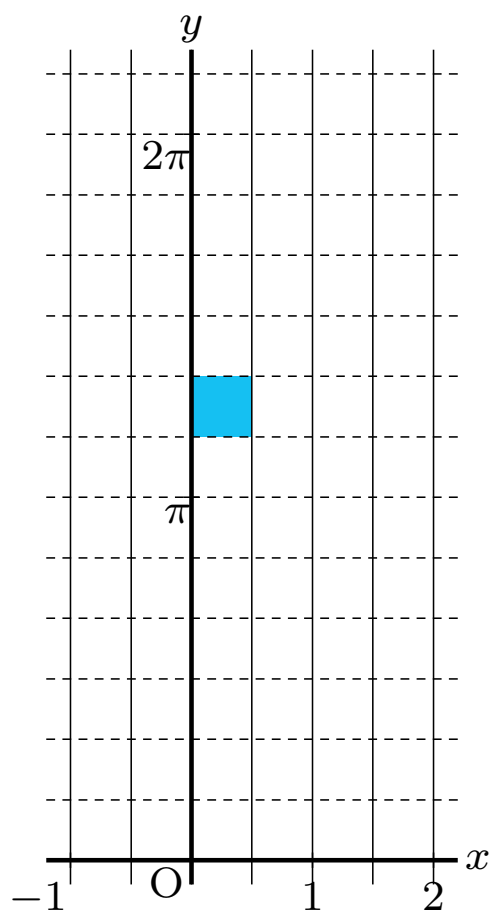

End

$w = e^z$ z -plane \longrightarrow w -plane

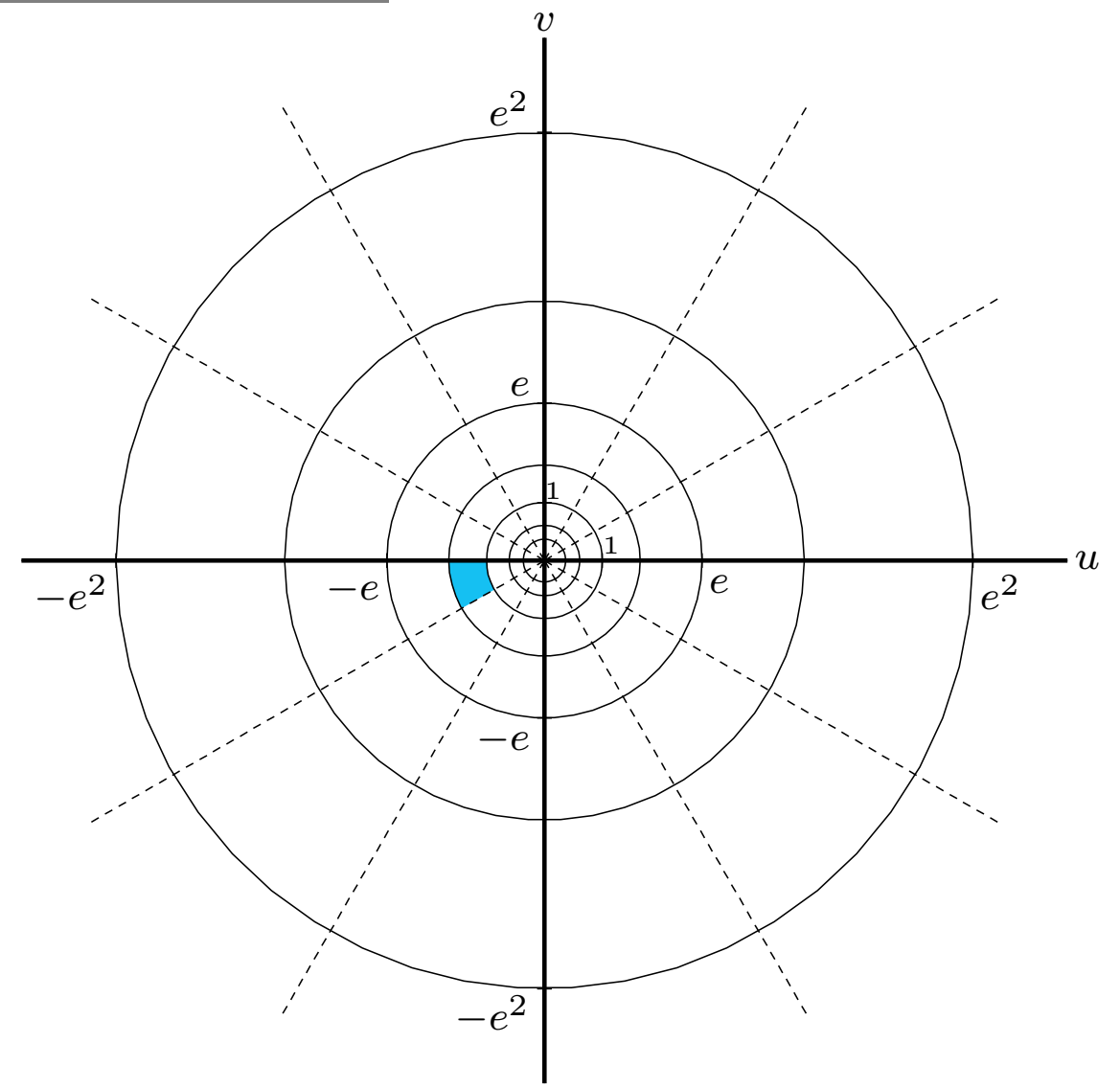
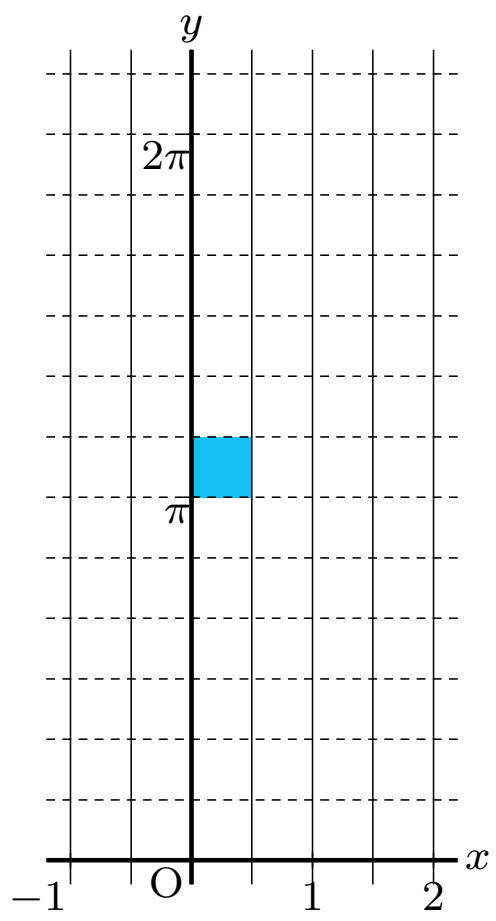

End

$w = e^z$ z -plane \longrightarrow w -plane

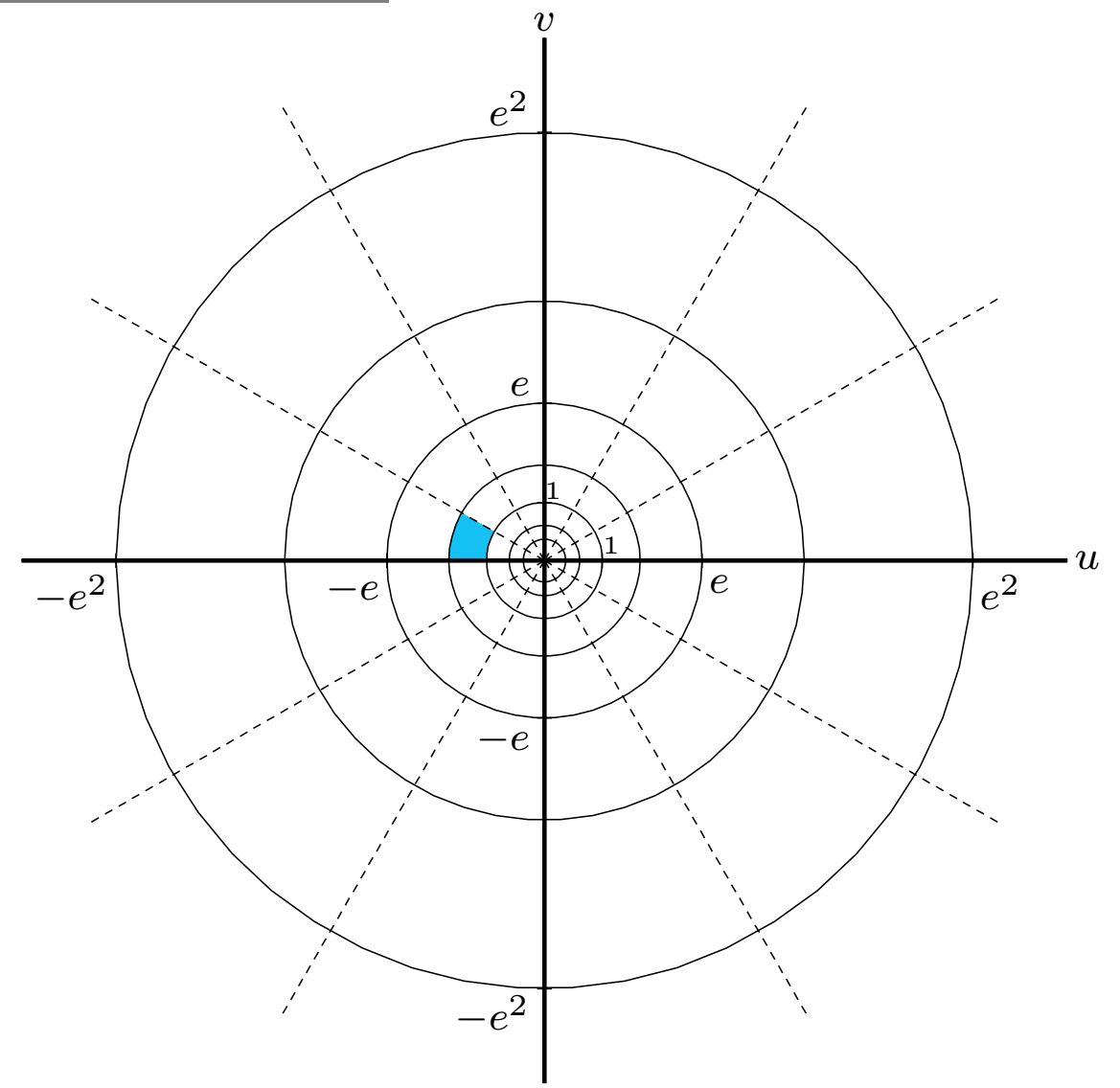
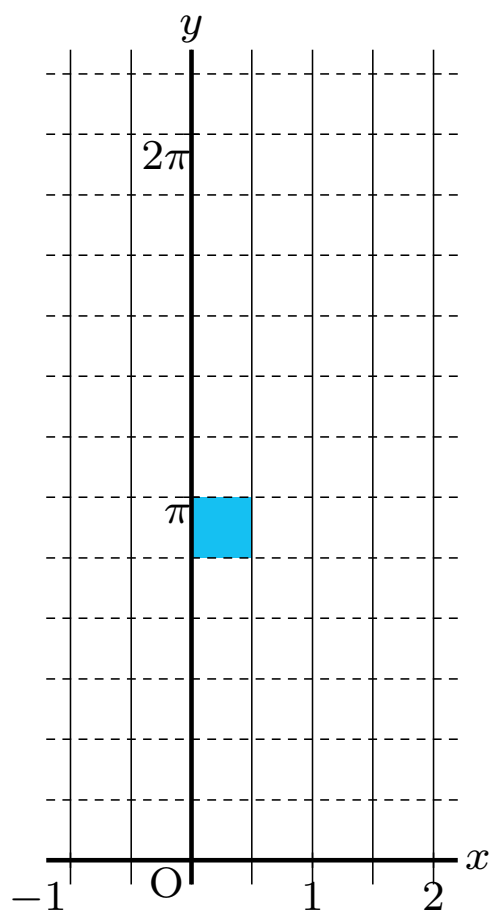

End

$w = e^z$ z -plane \longrightarrow w -plane

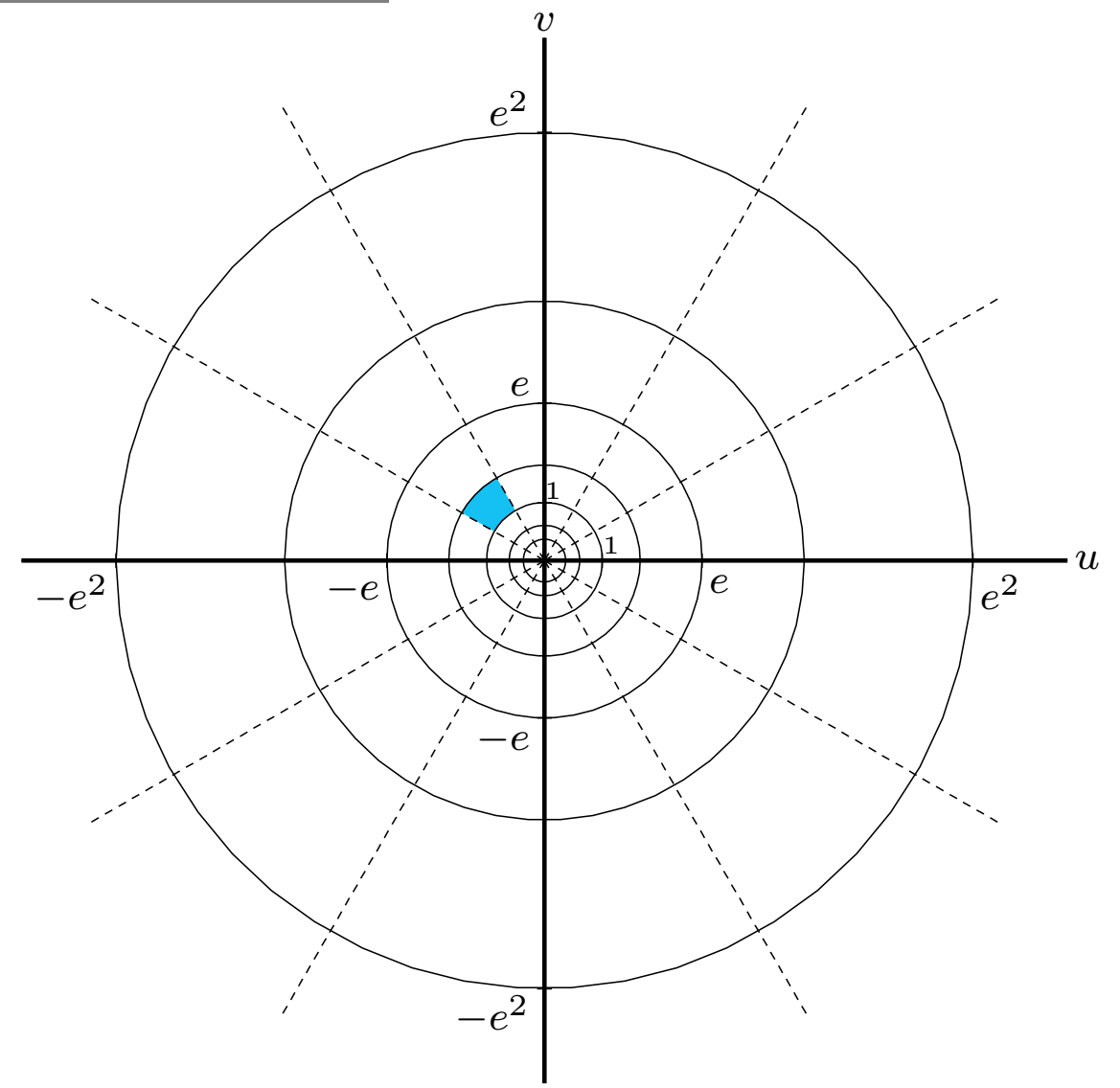
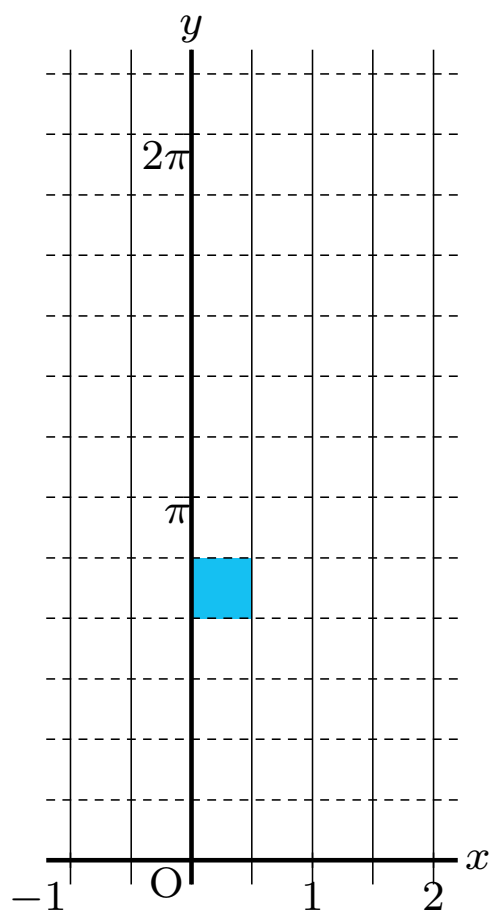

End

$w = e^z$ z -plane \longrightarrow w -plane

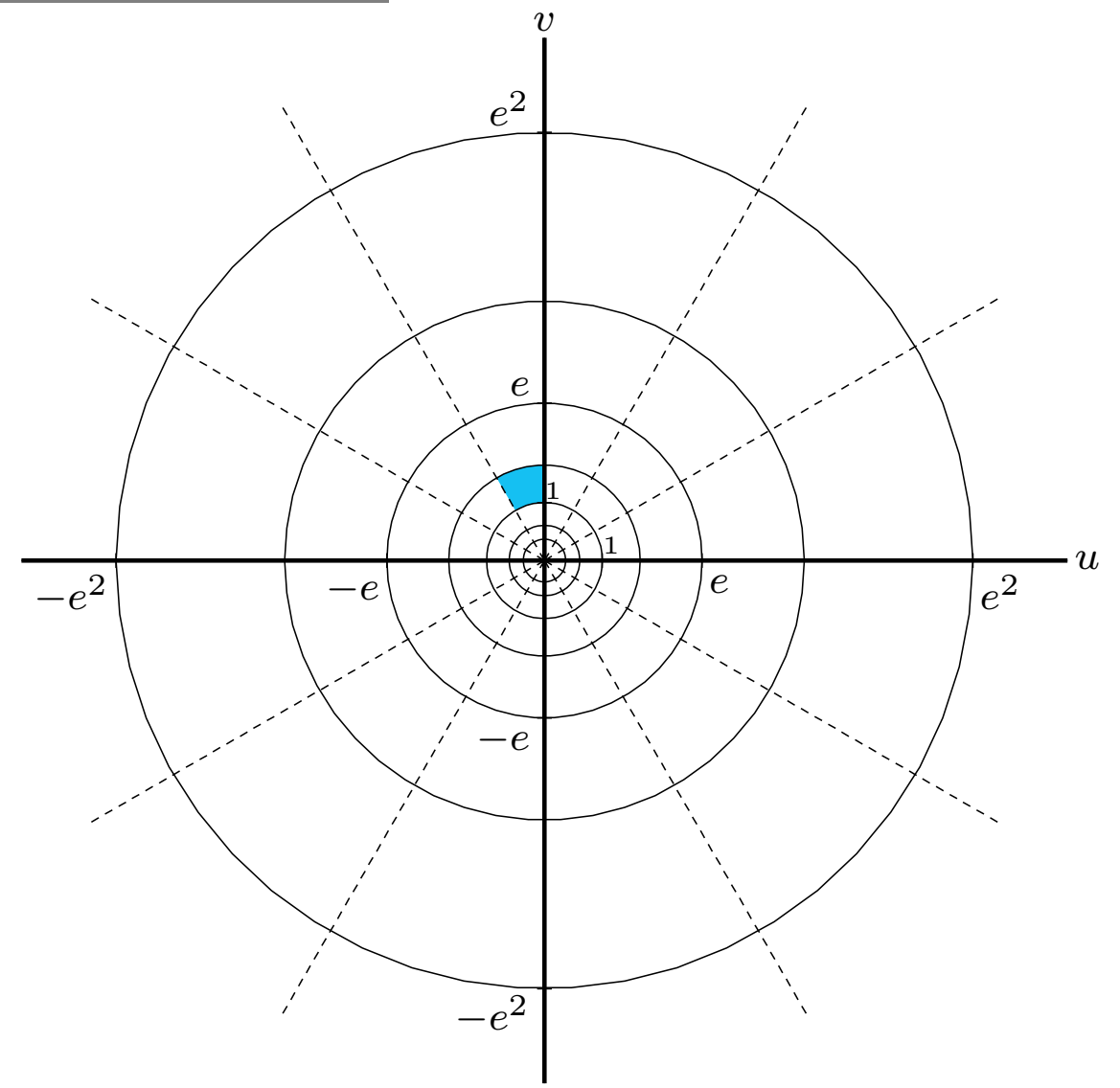
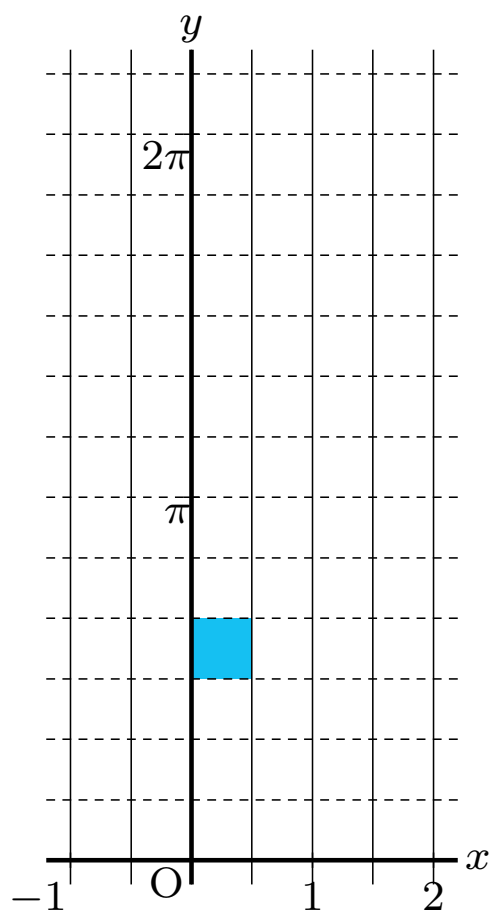

End

$w = e^z$ z -plane \longrightarrow w -plane

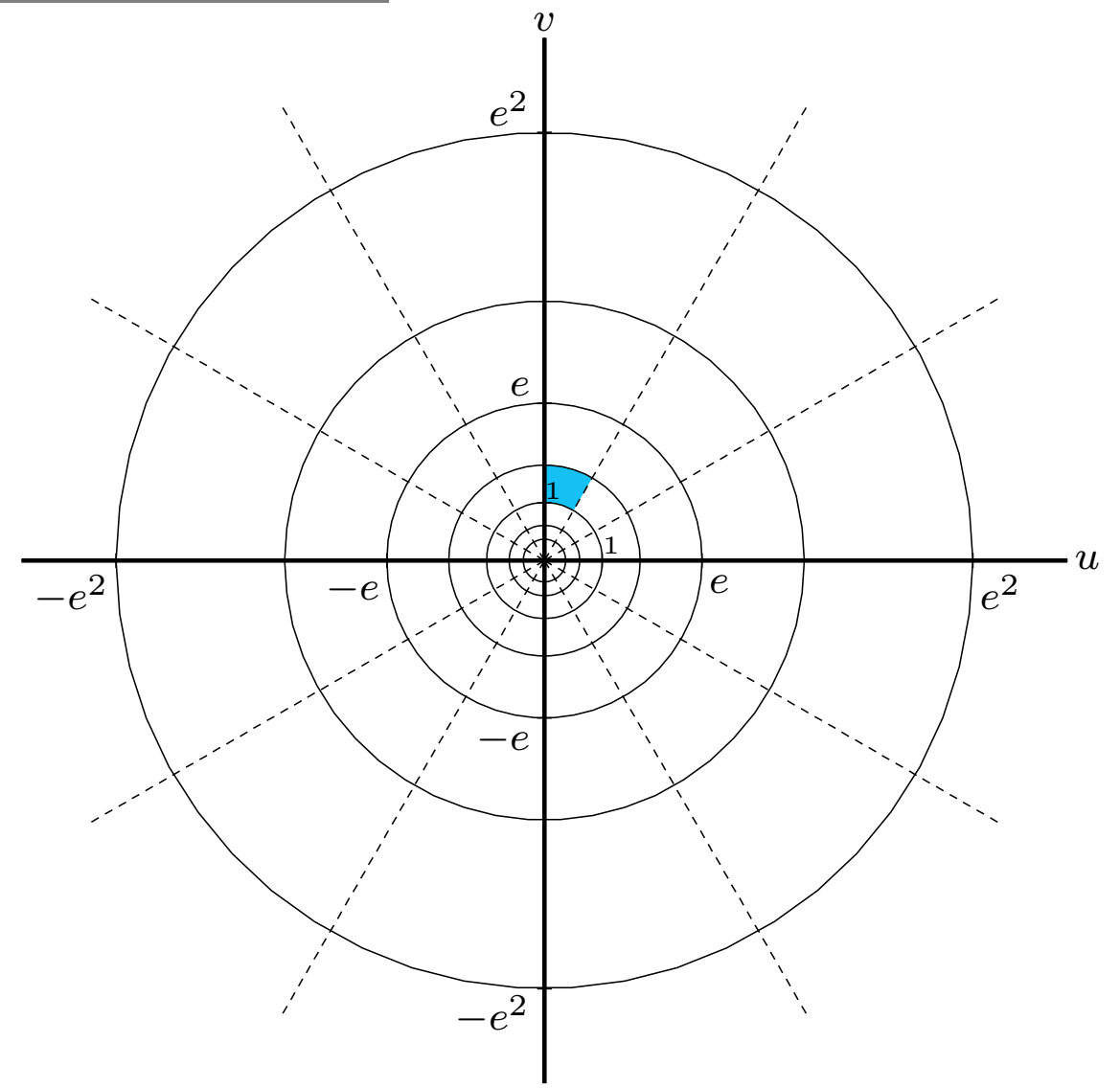
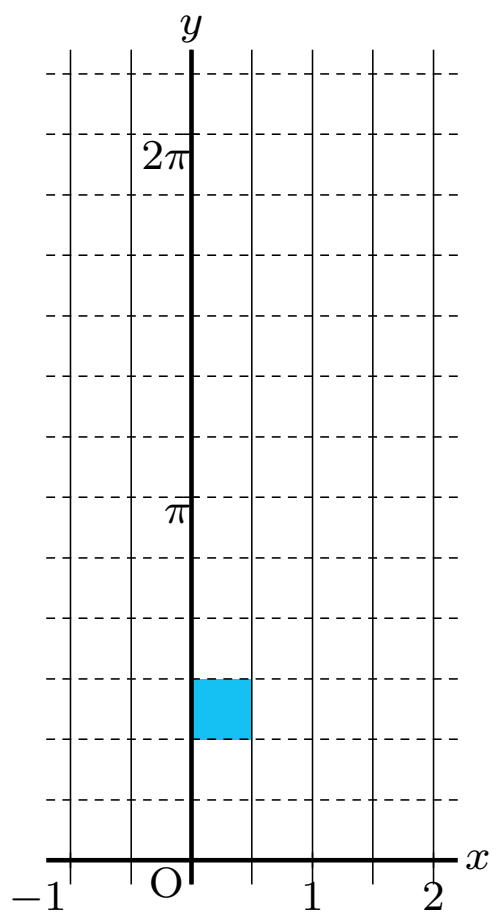

End

$w = e^z$ z -plane \longrightarrow w -plane

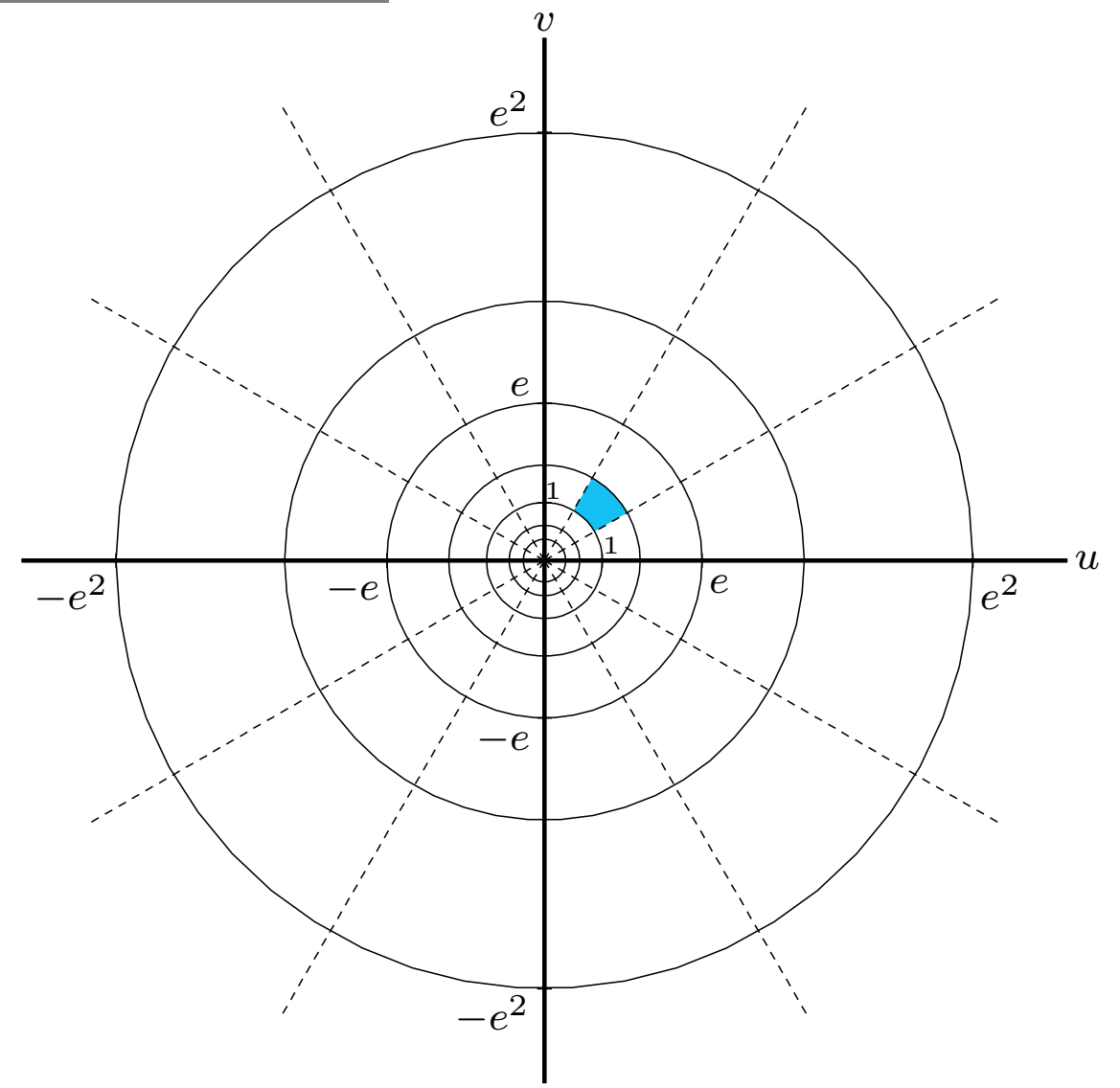
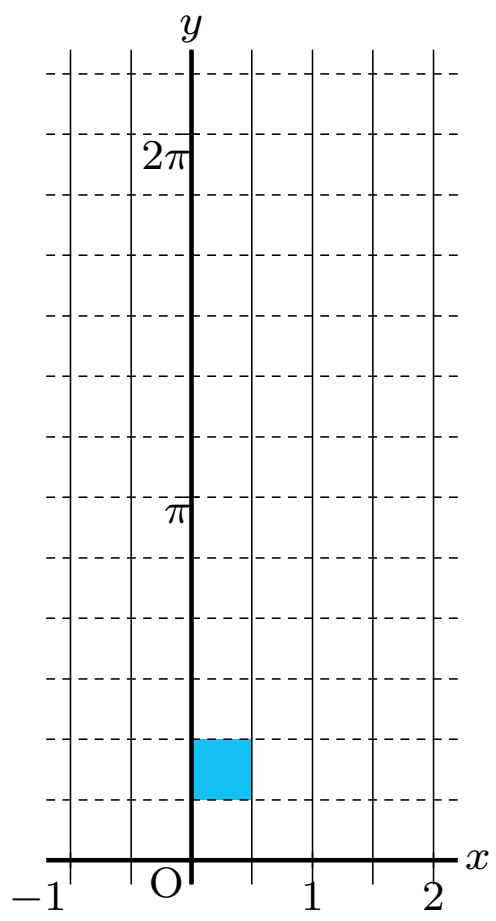

End

$w = e^z$ z -plane \longrightarrow w -plane

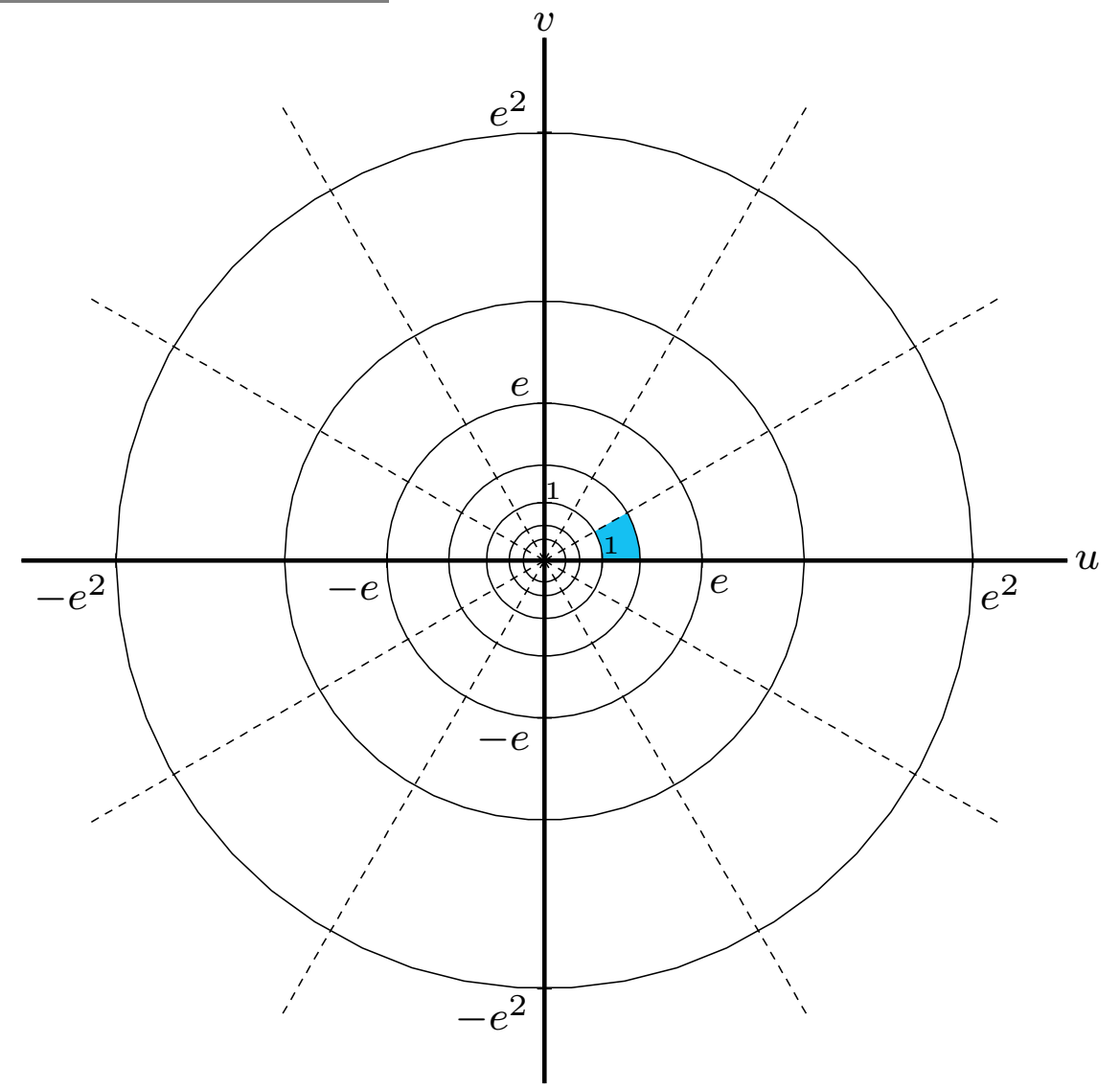
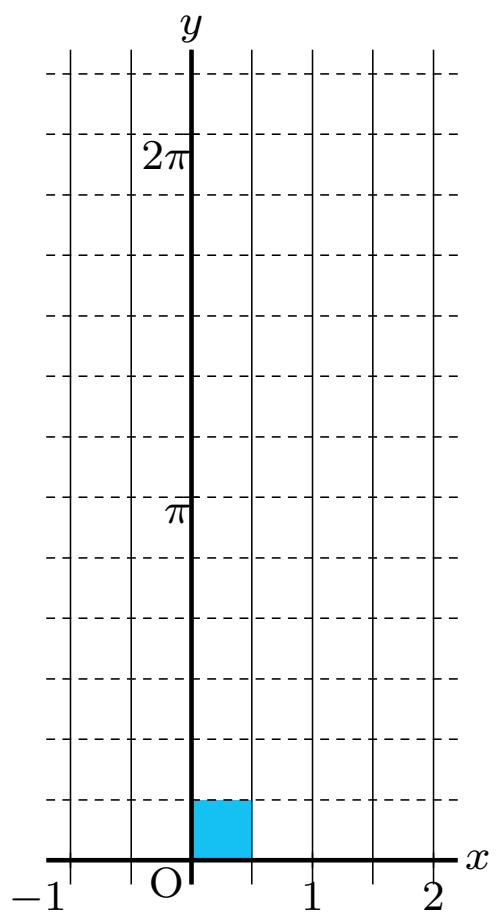

End

$w = e^z$ z -plane \longrightarrow w -plane

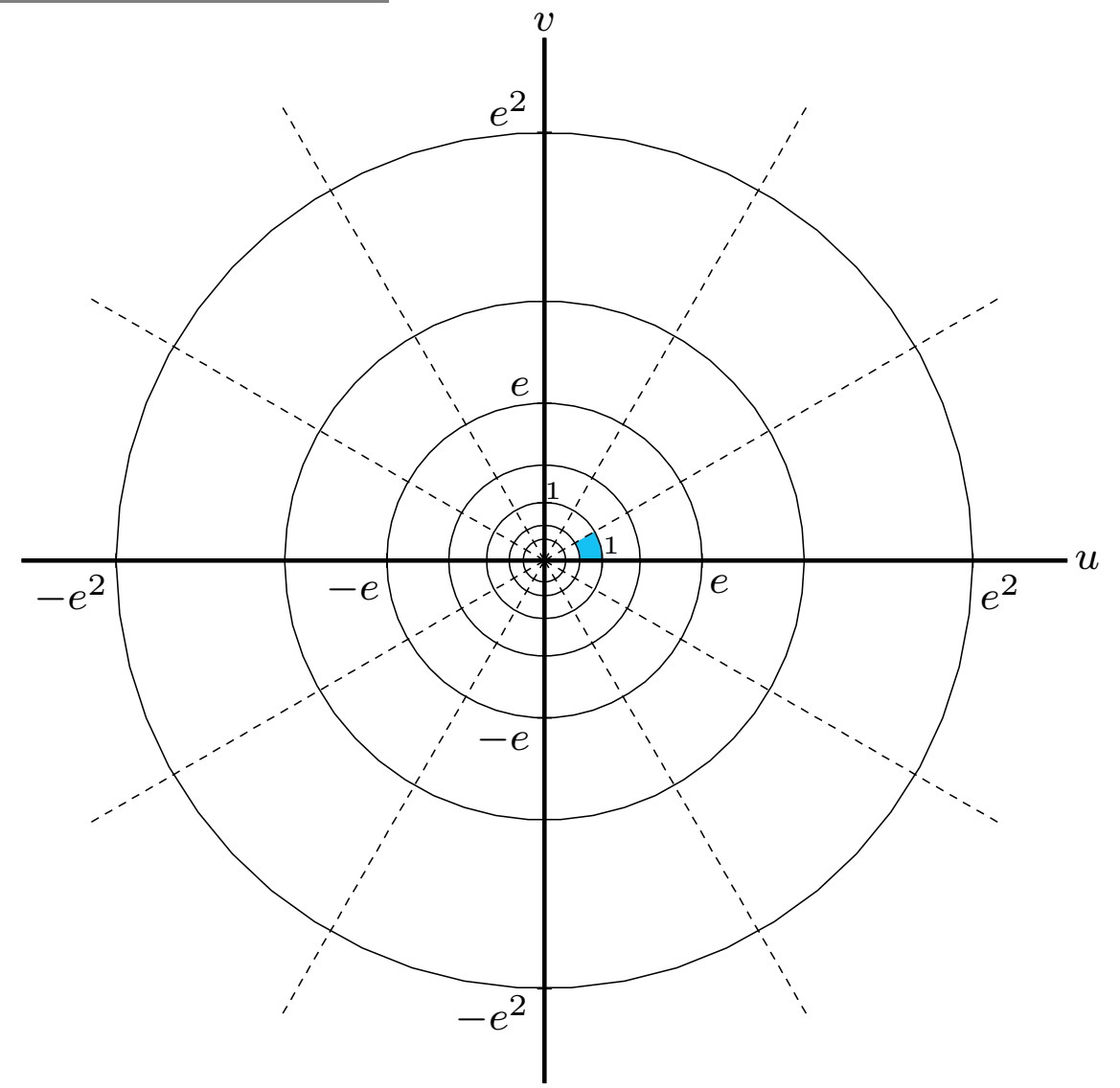
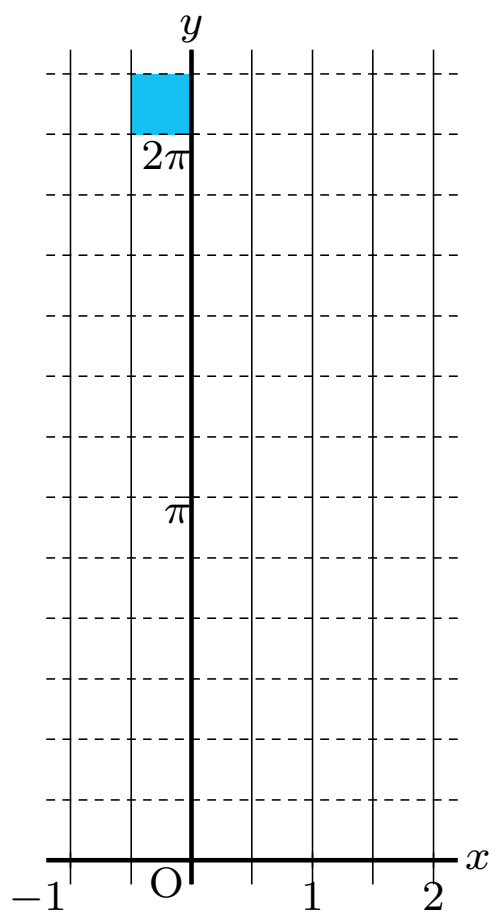

End

$w = e^z$ z -plane \longrightarrow w -plane

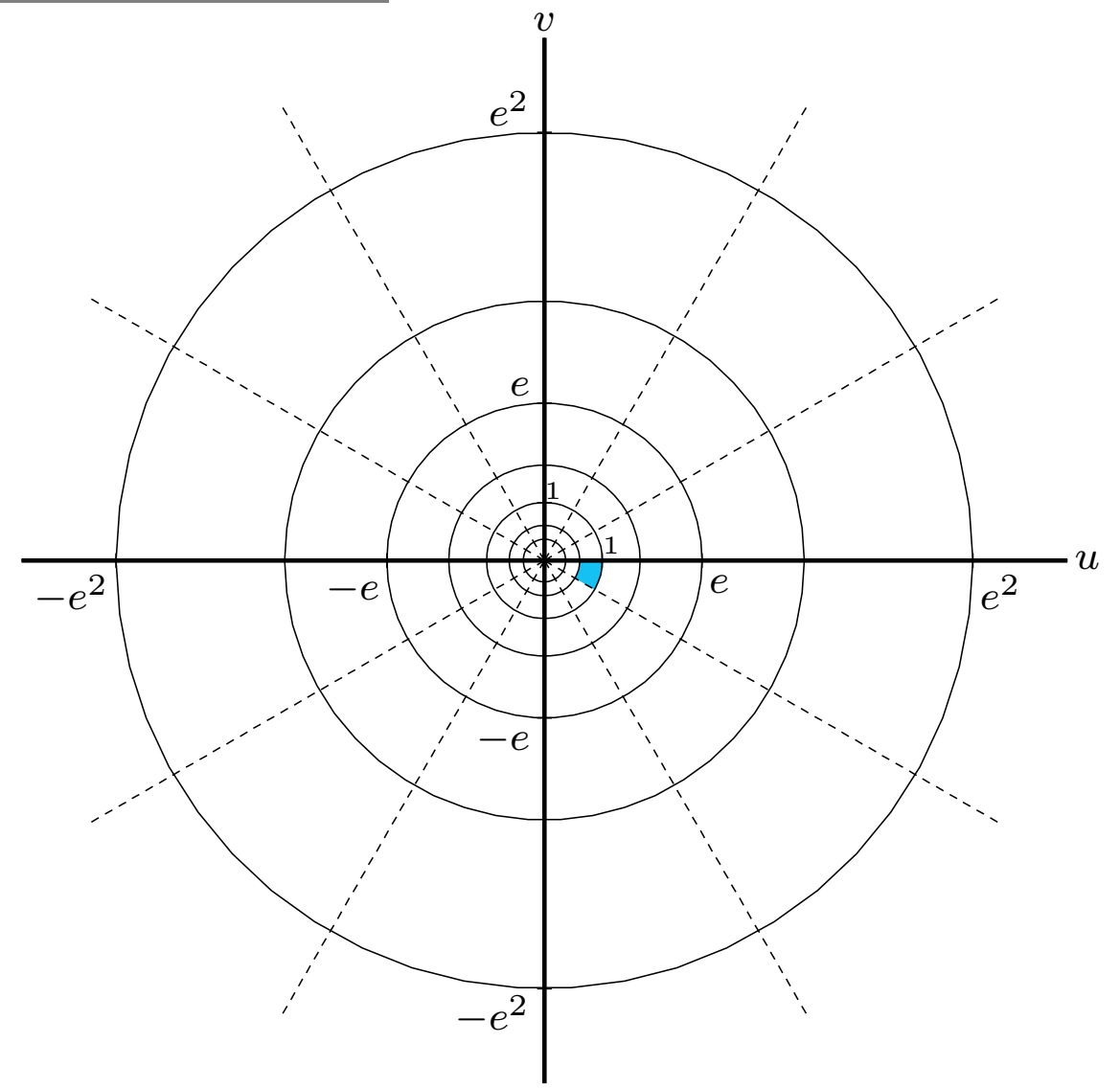
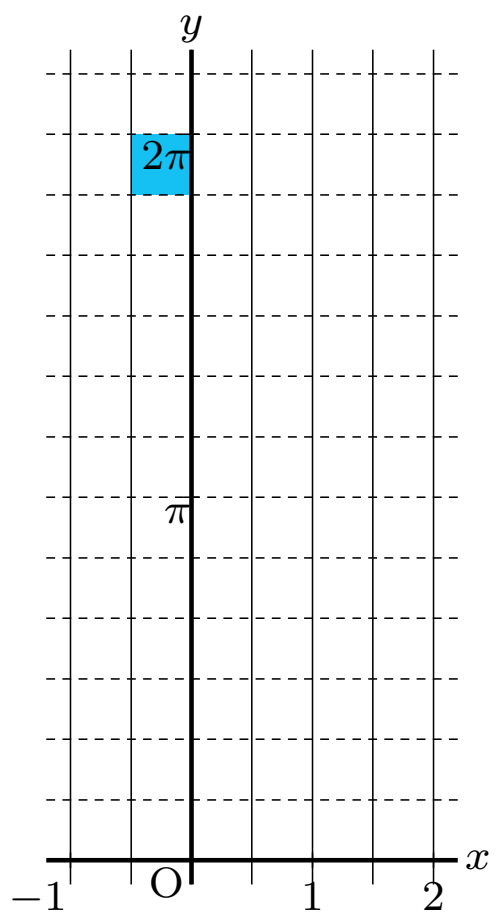

End

$w = e^z$ z -plane \longrightarrow w -plane

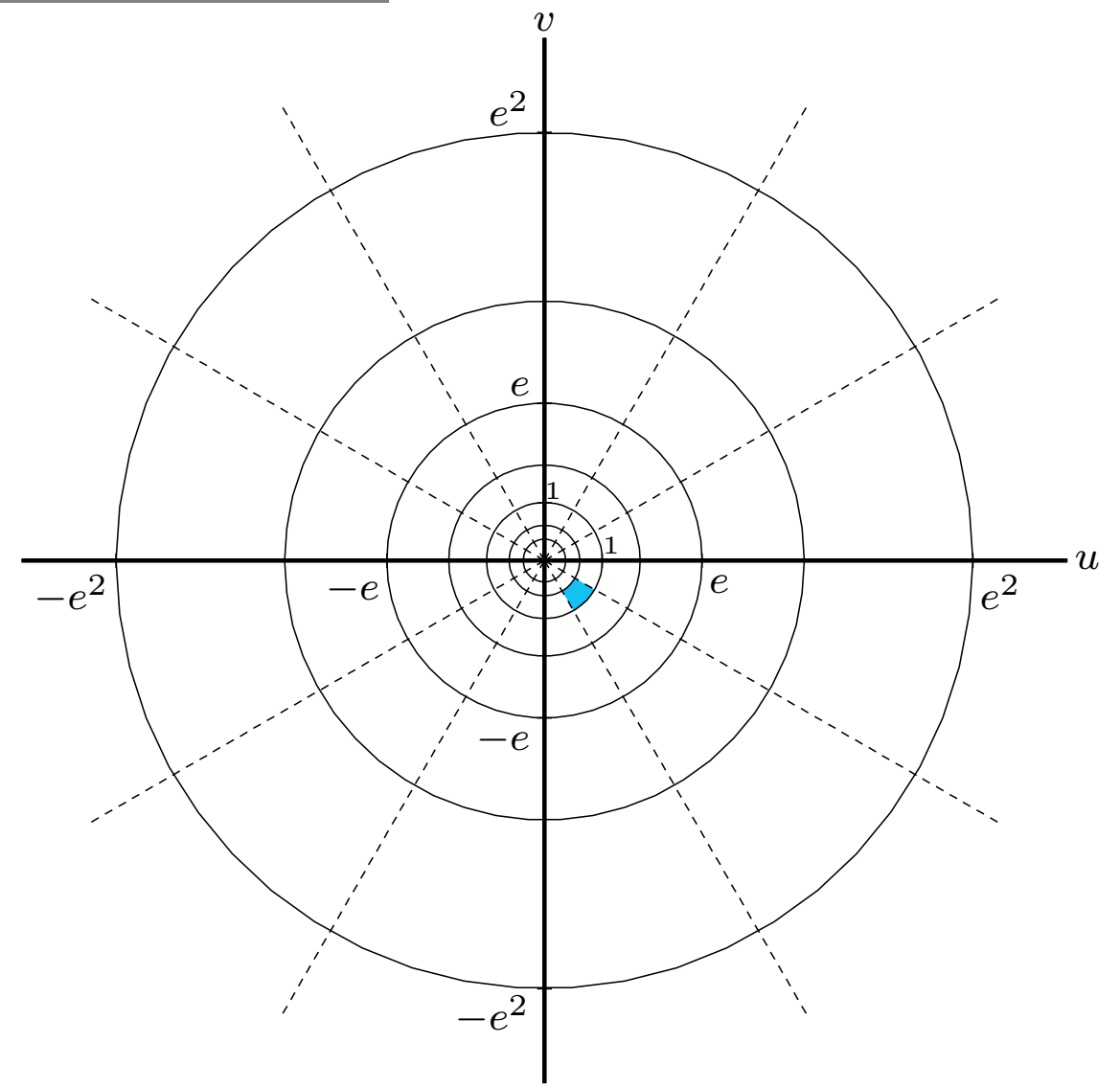
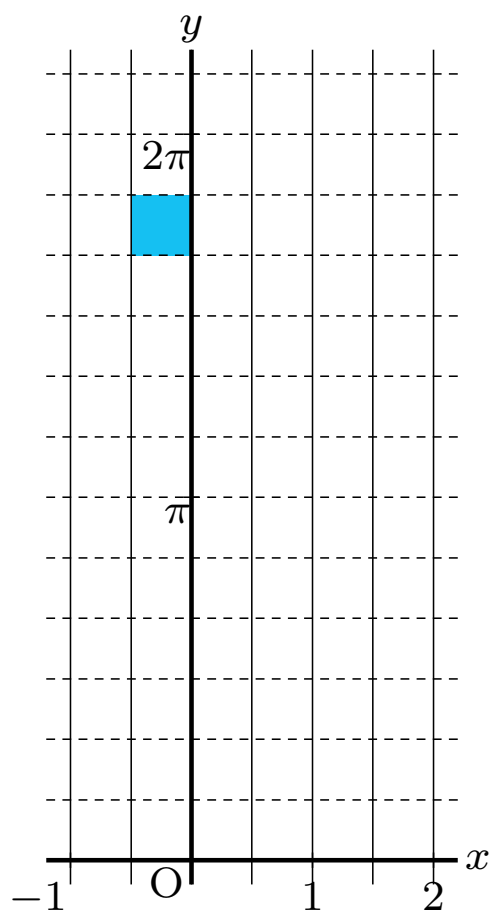

End

$w = e^z$ z -plane \longrightarrow w -plane

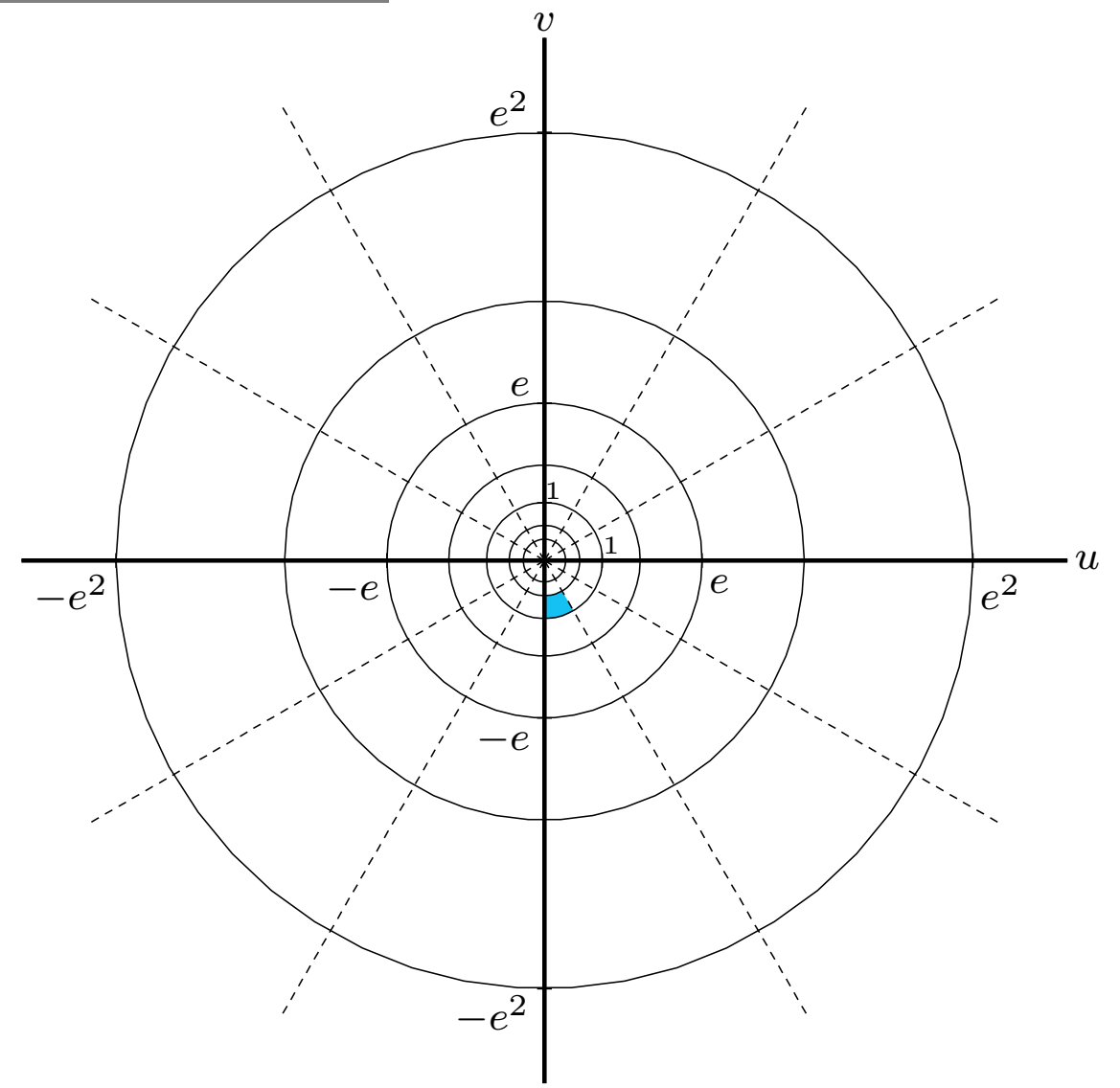
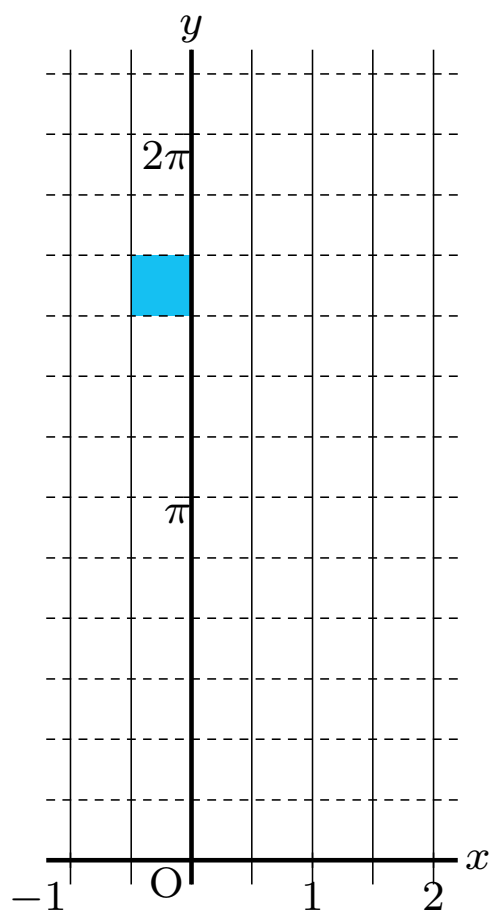

End

$w = e^z$ z -plane \longrightarrow w -plane

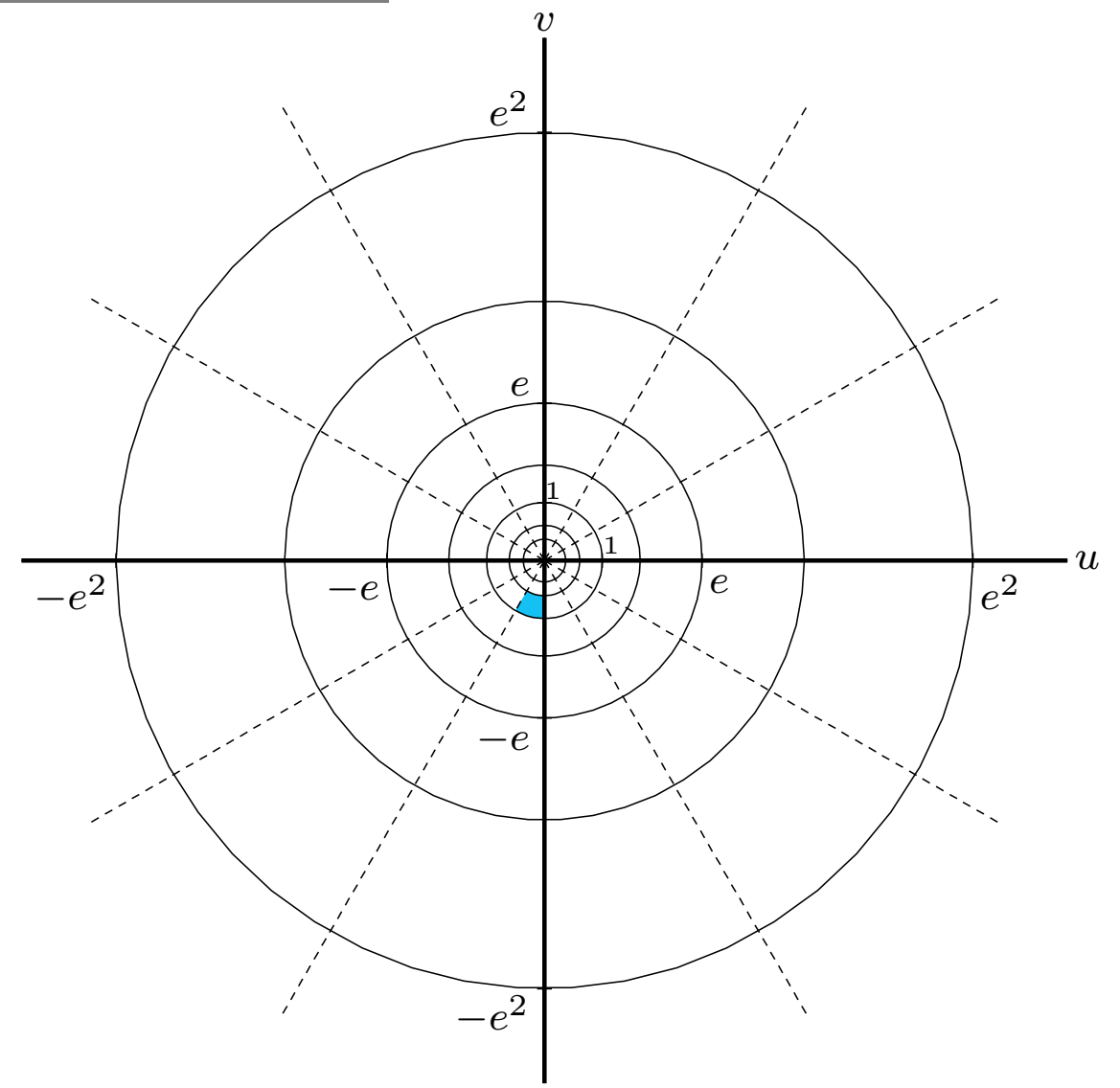
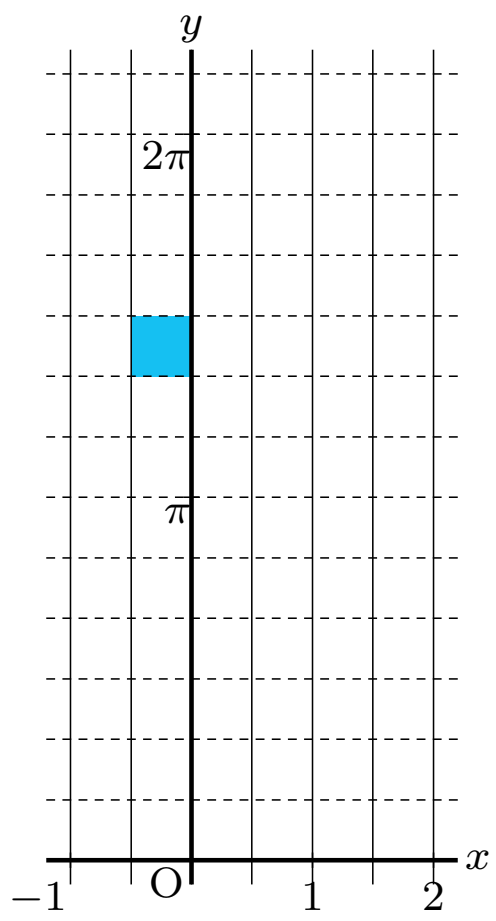

End

$w = e^z$ z -plane \longrightarrow w -plane

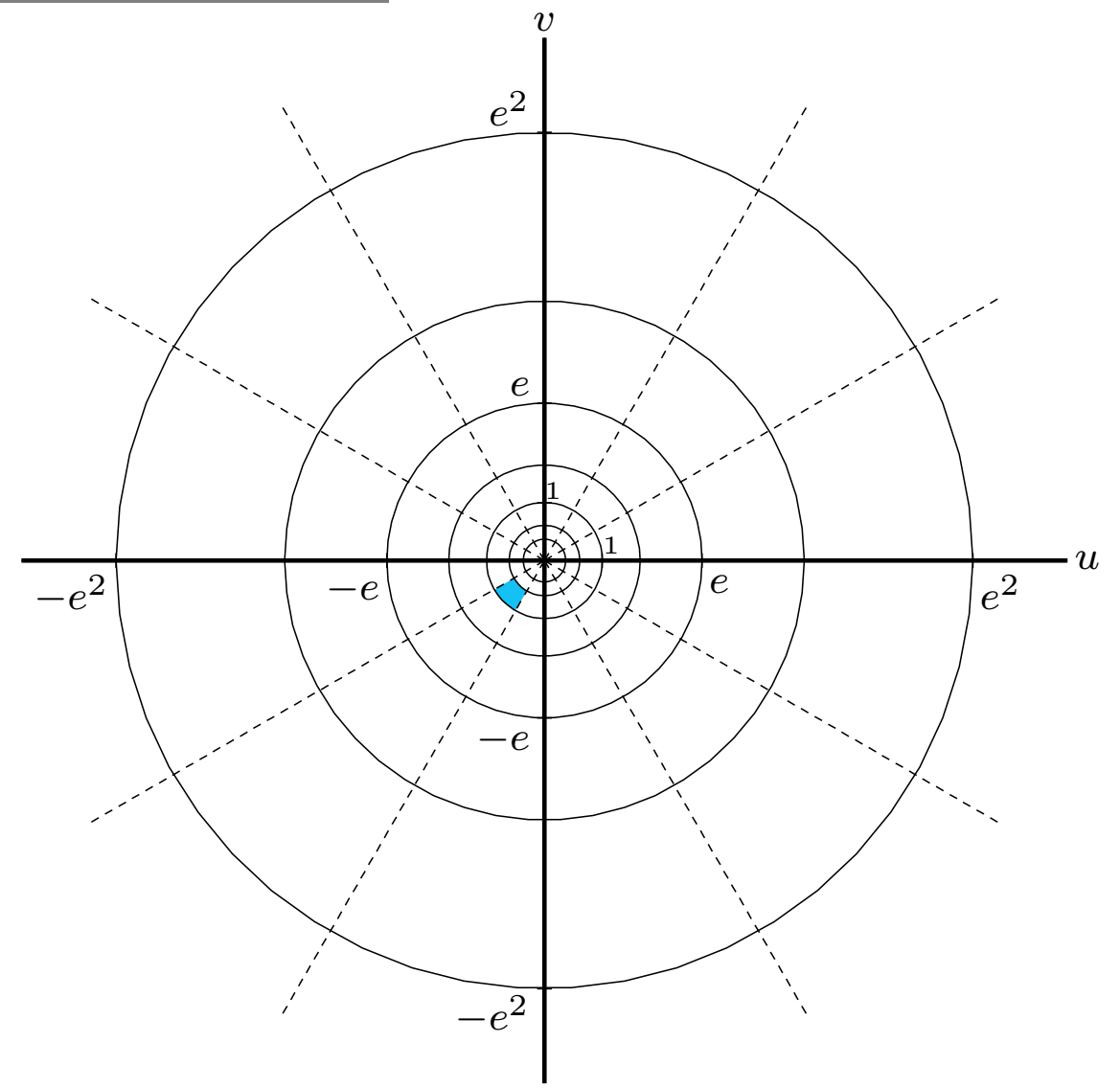
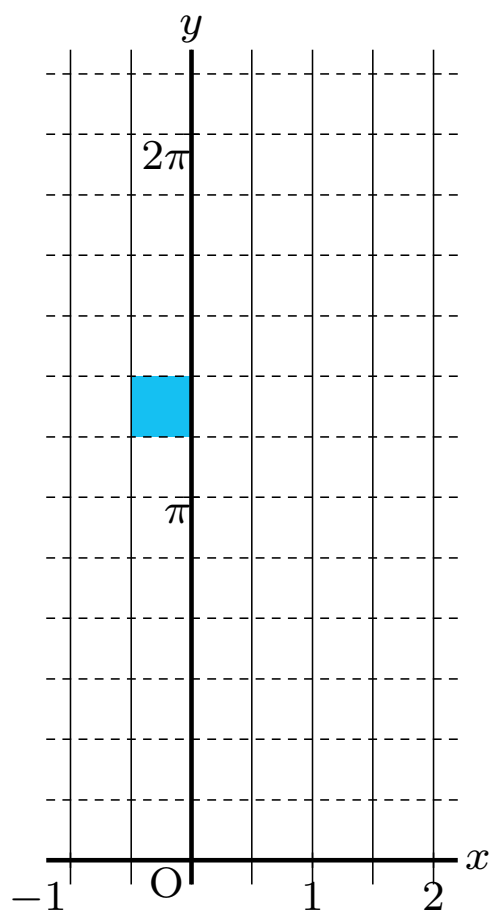

End

$w = e^z$ z -plane \longrightarrow w -plane

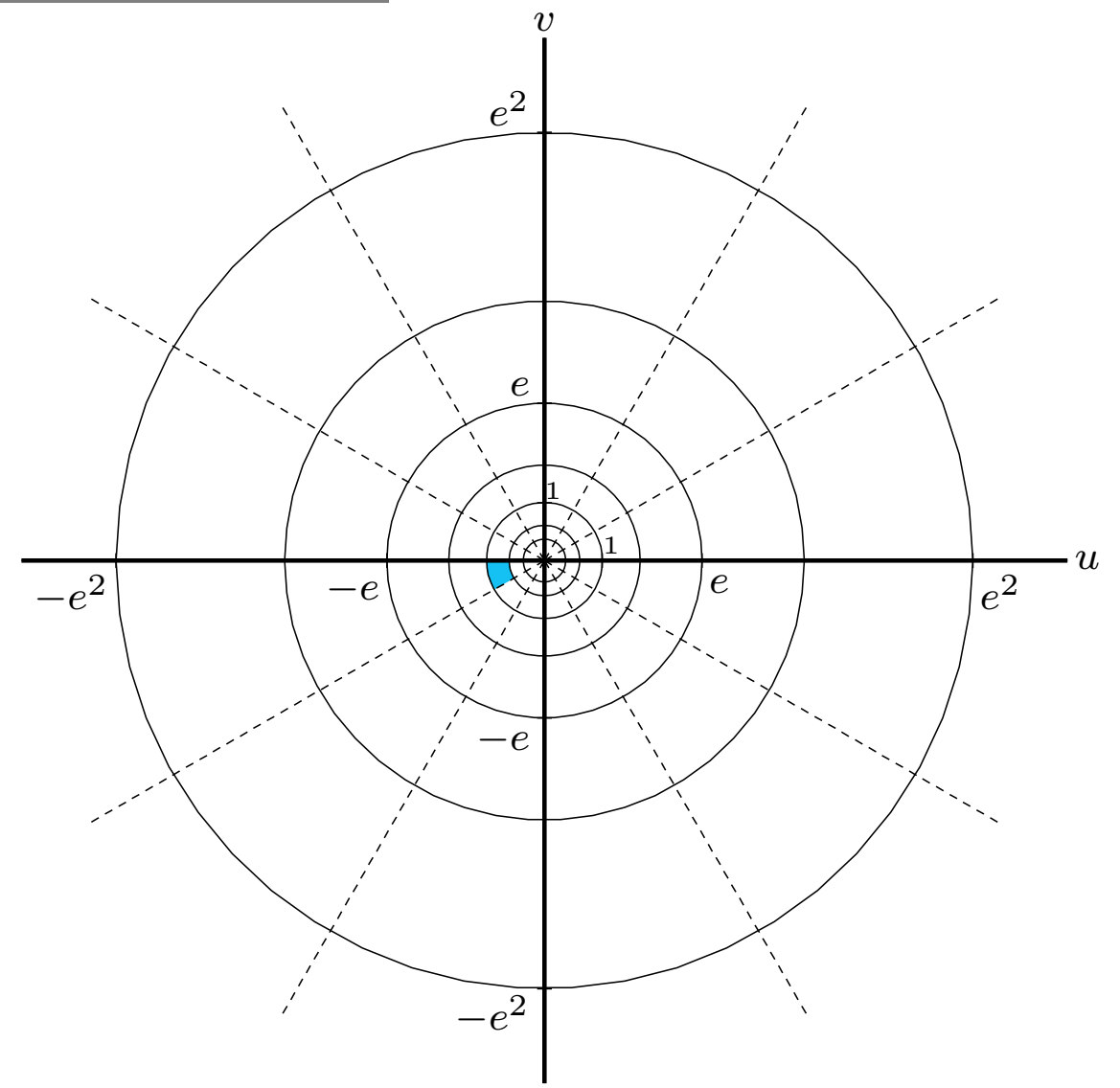
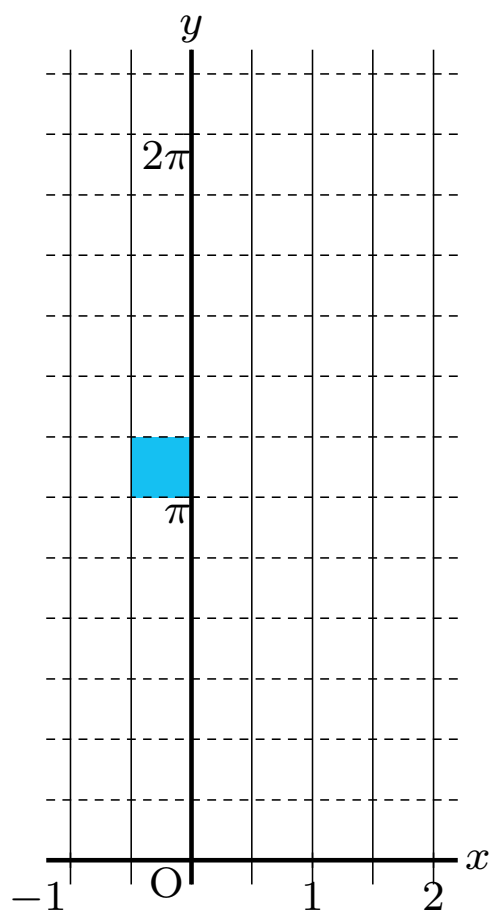

End

$w = e^z$ z -plane \longrightarrow w -plane

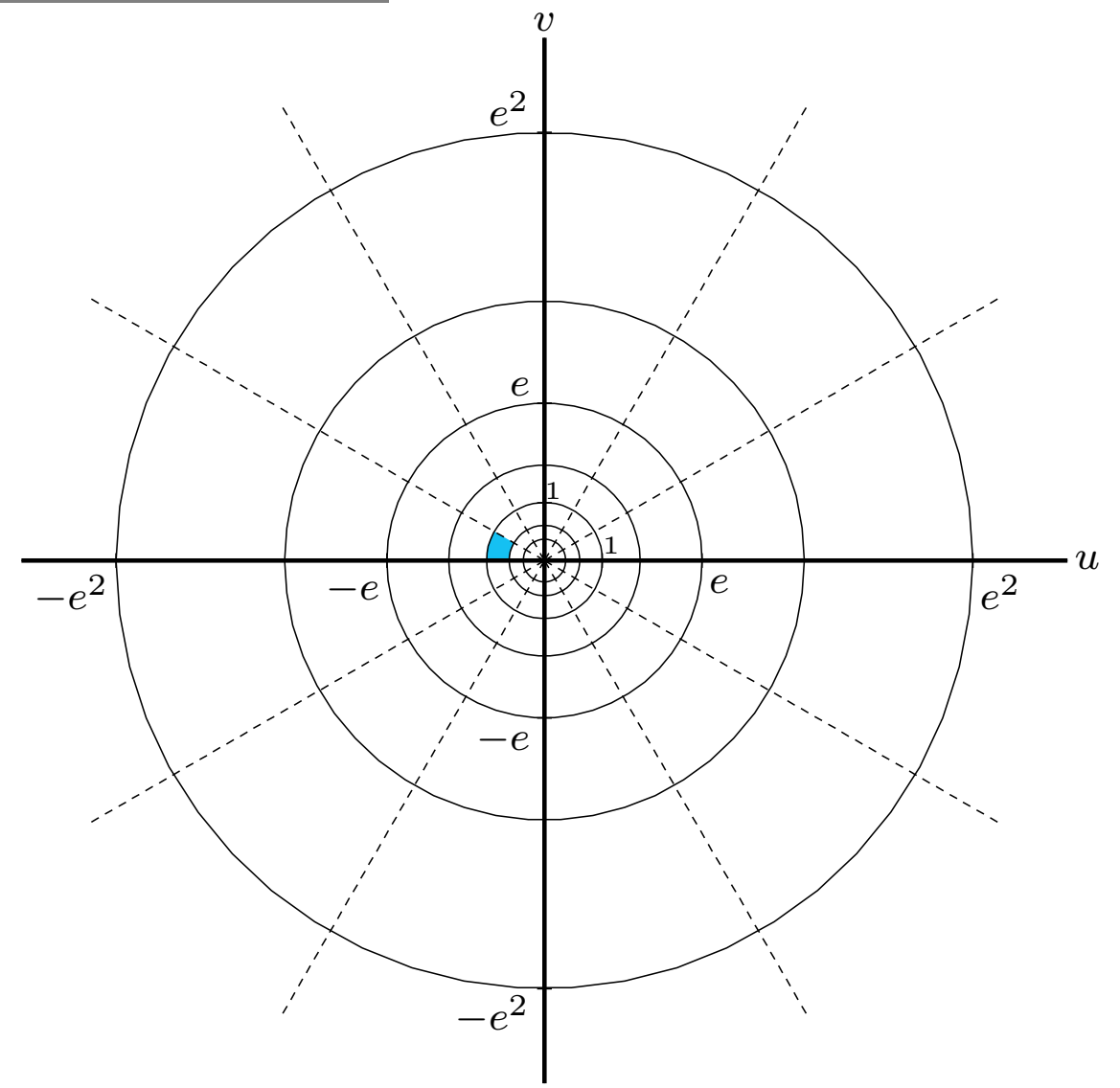
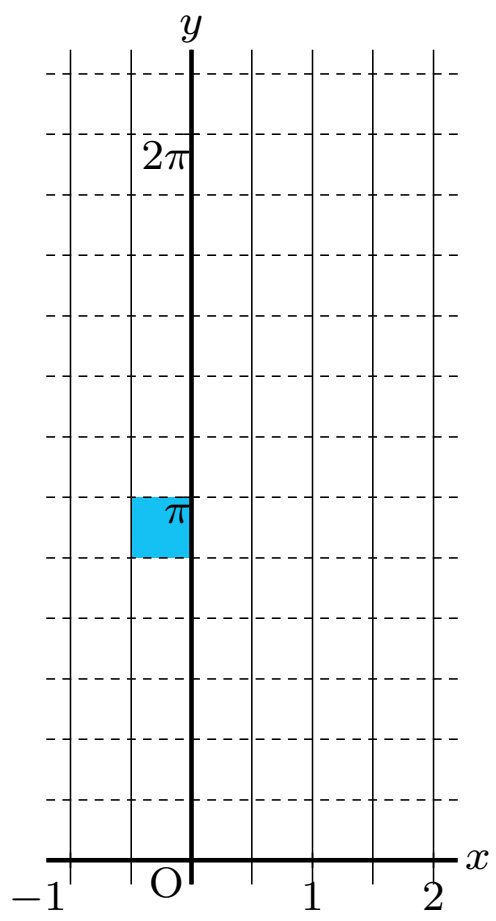

End

$w = e^z$ z -plane \longrightarrow w -plane

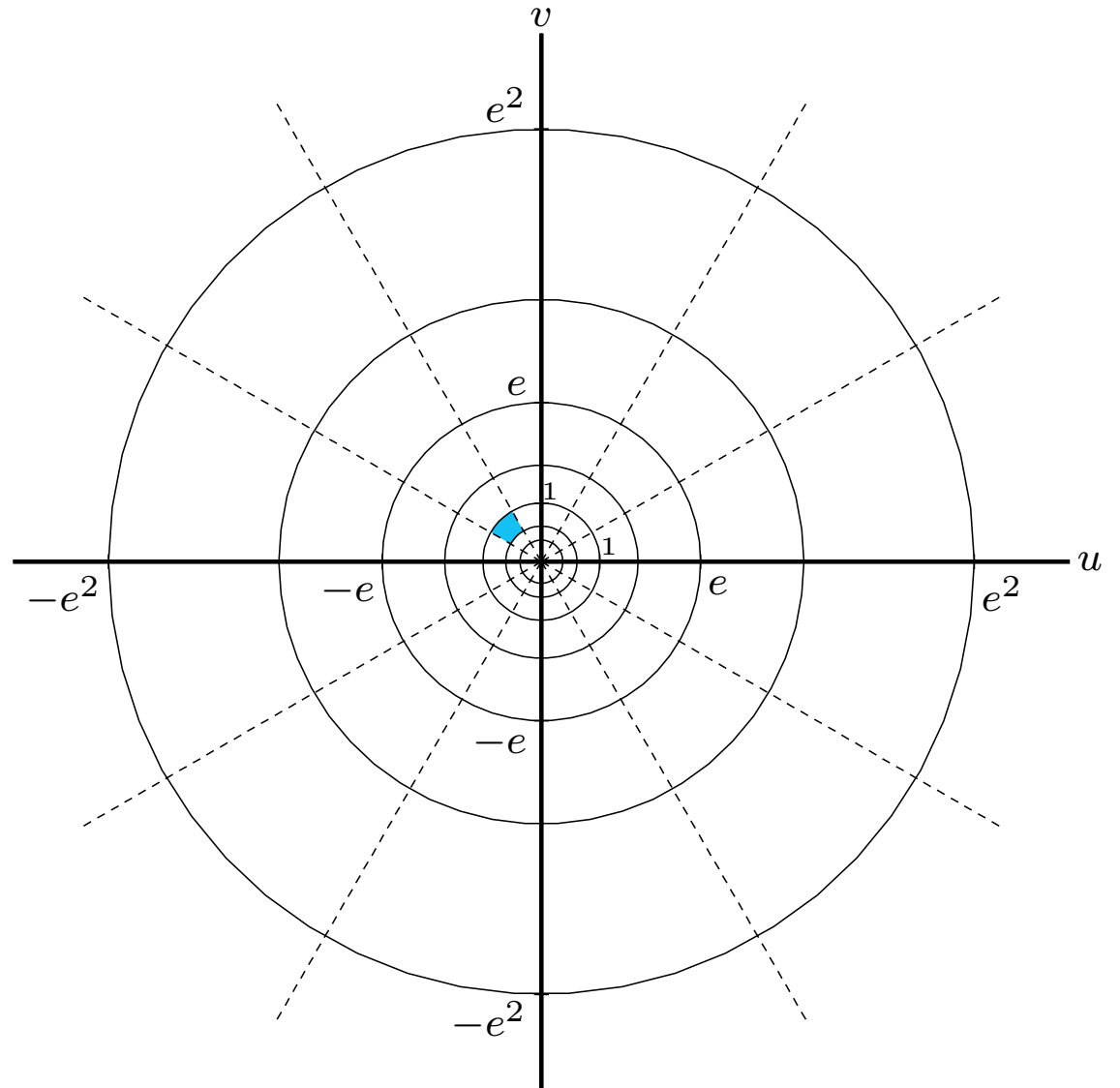
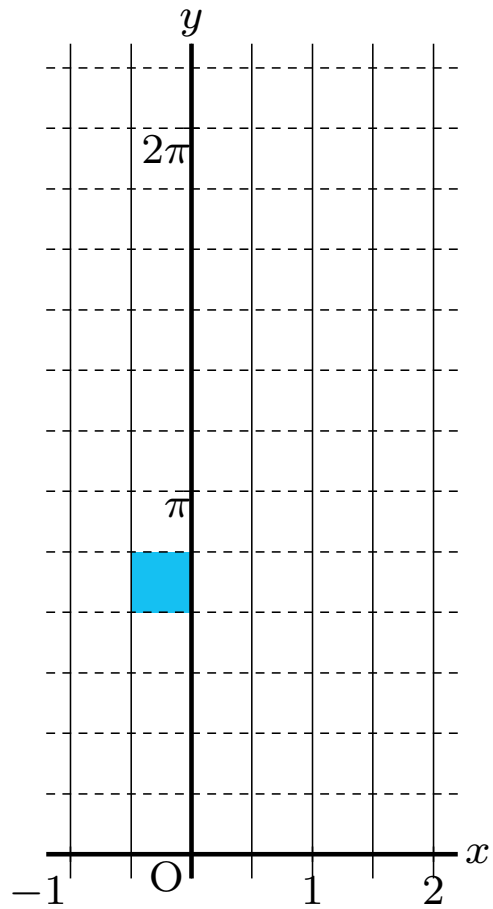

End

$w = e^z$ z -plane \longrightarrow w -plane

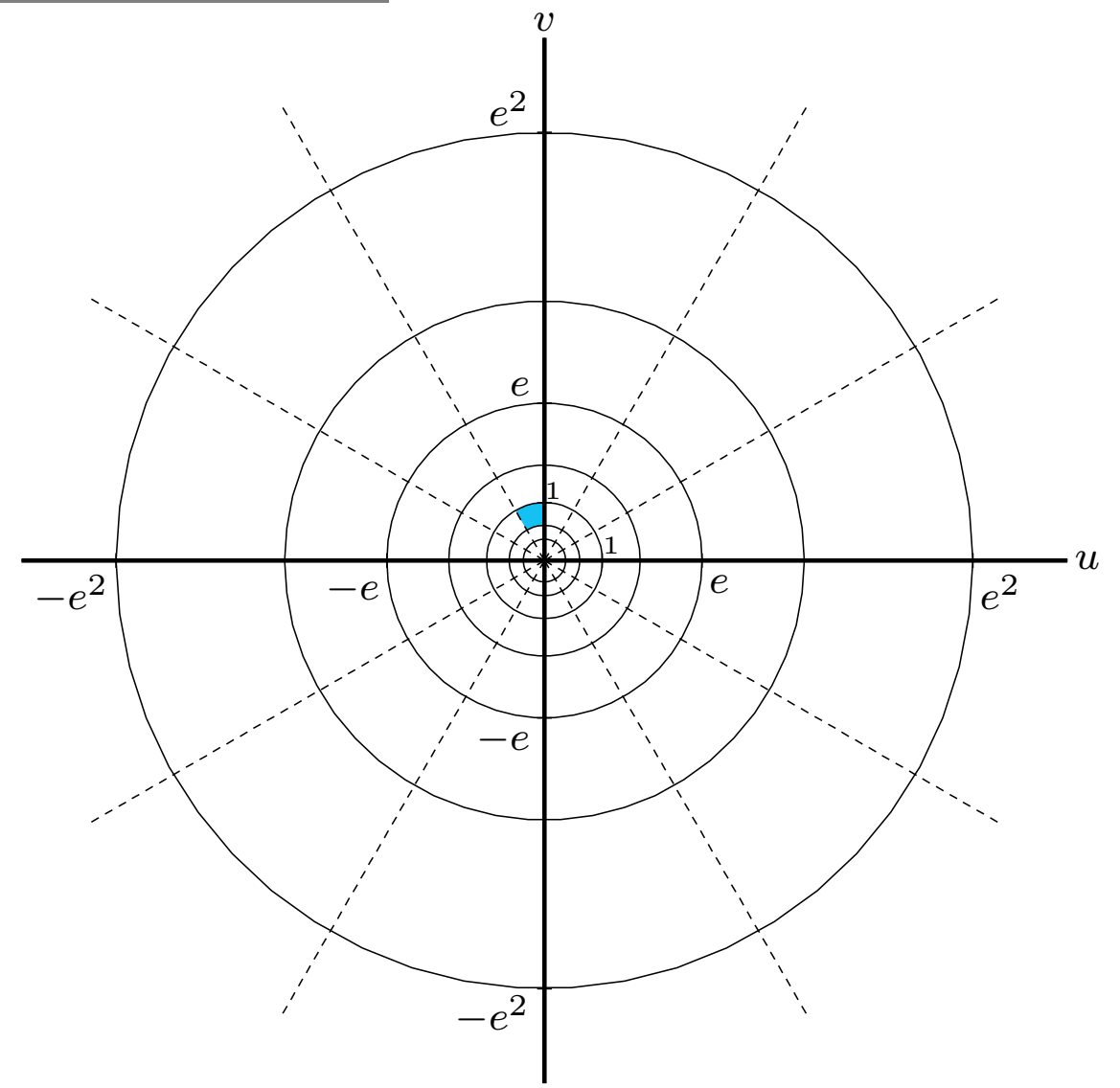
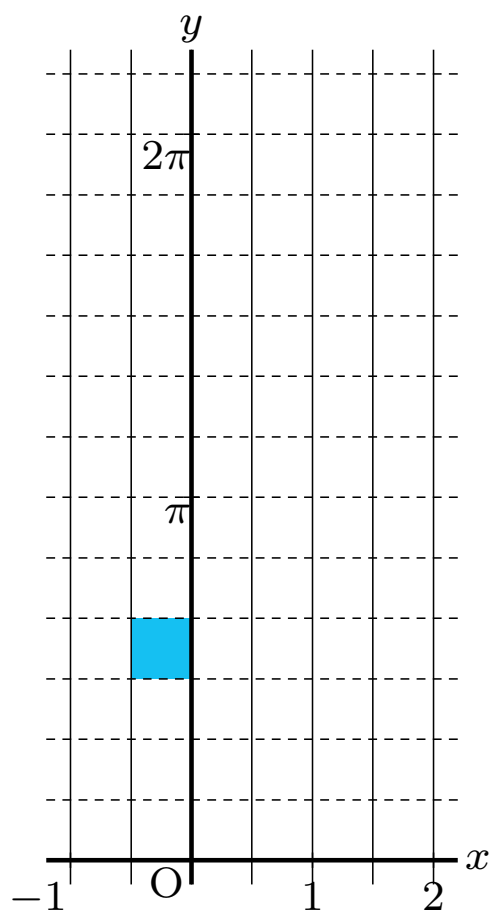

End

$w = e^z$ z -plane \longrightarrow w -plane

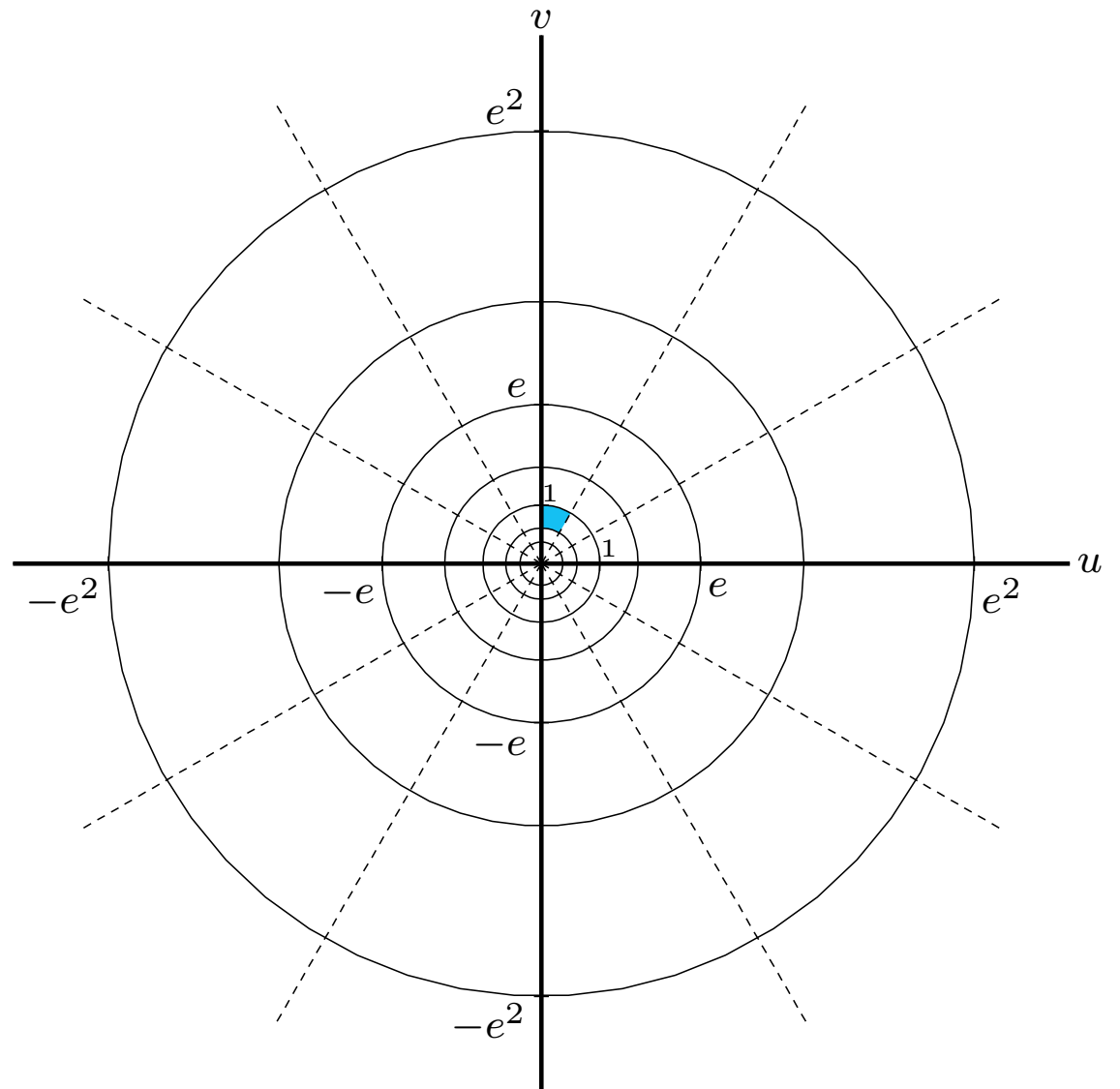
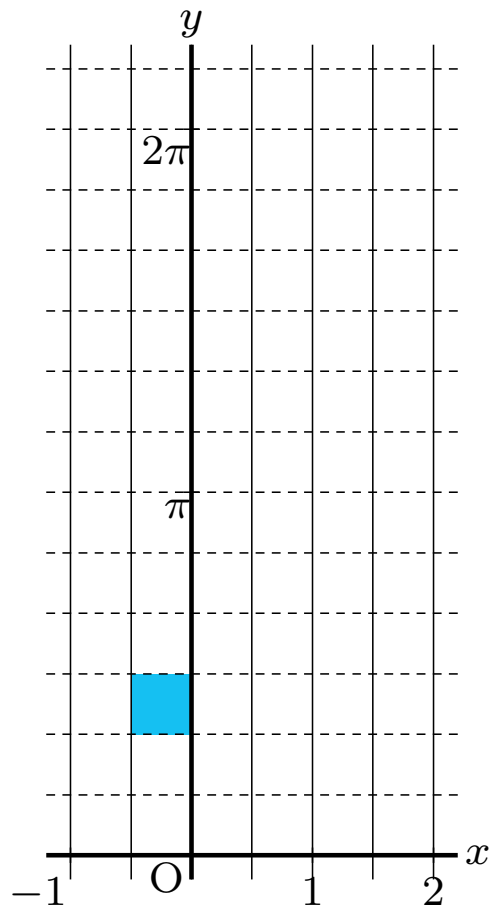

End

$w = e^z$ z -plane \longrightarrow w -plane

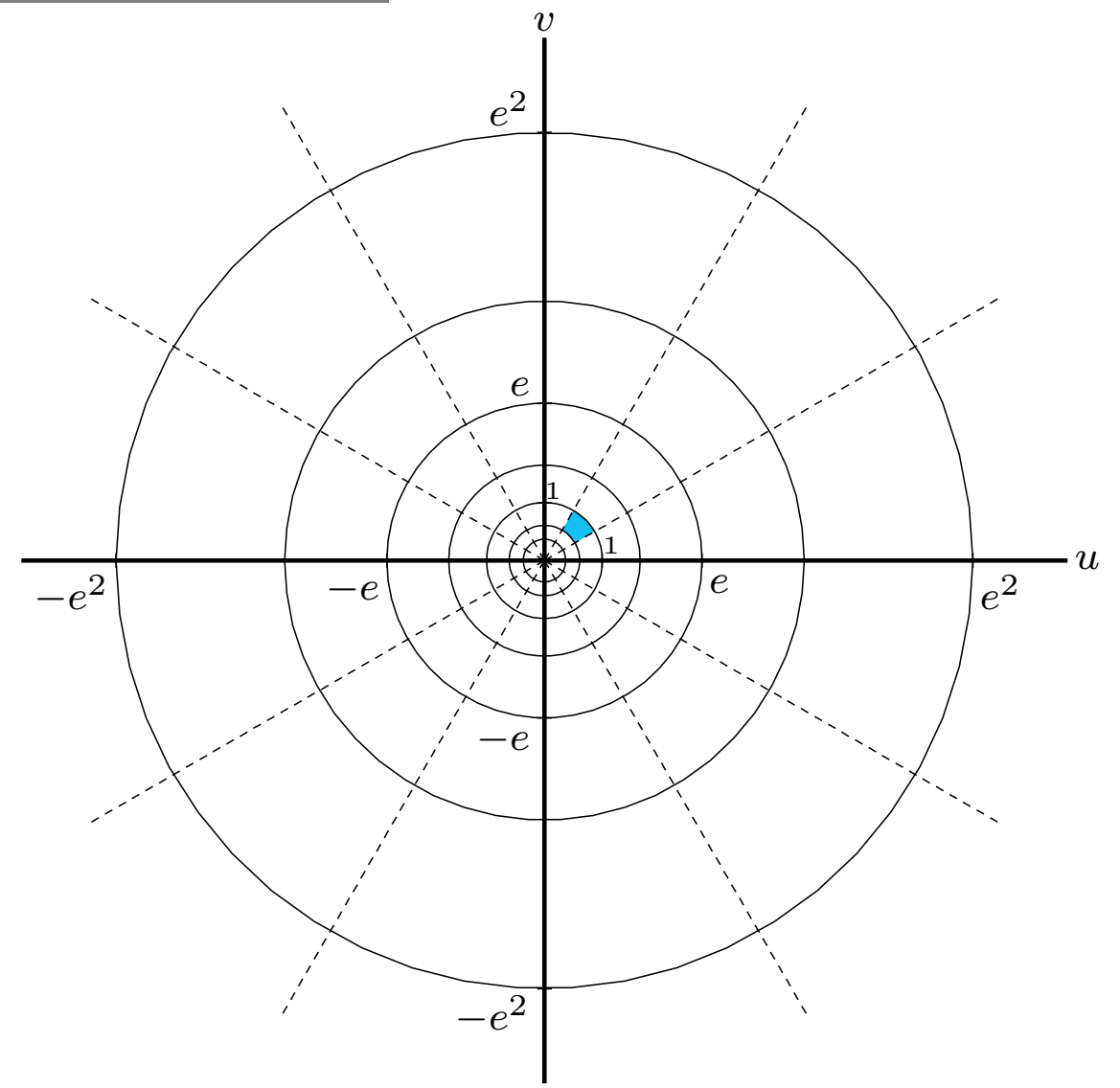
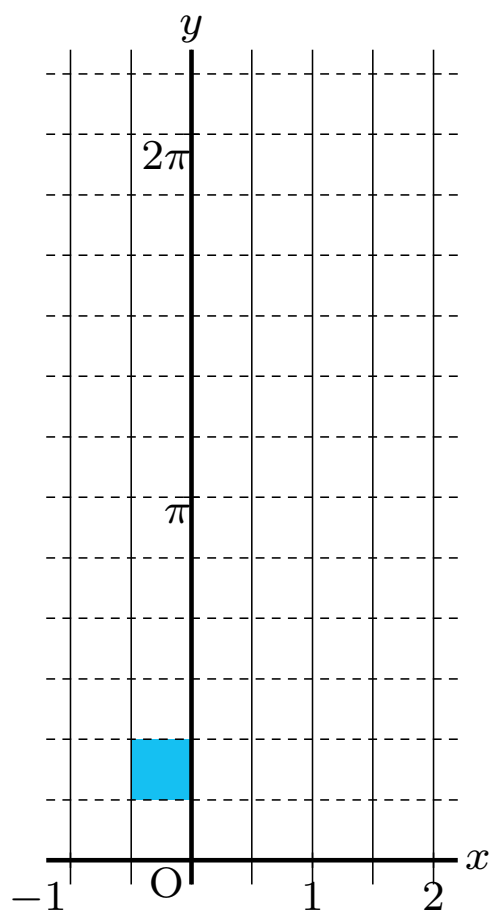

End

$w = e^z$ z -plane \longrightarrow w -plane

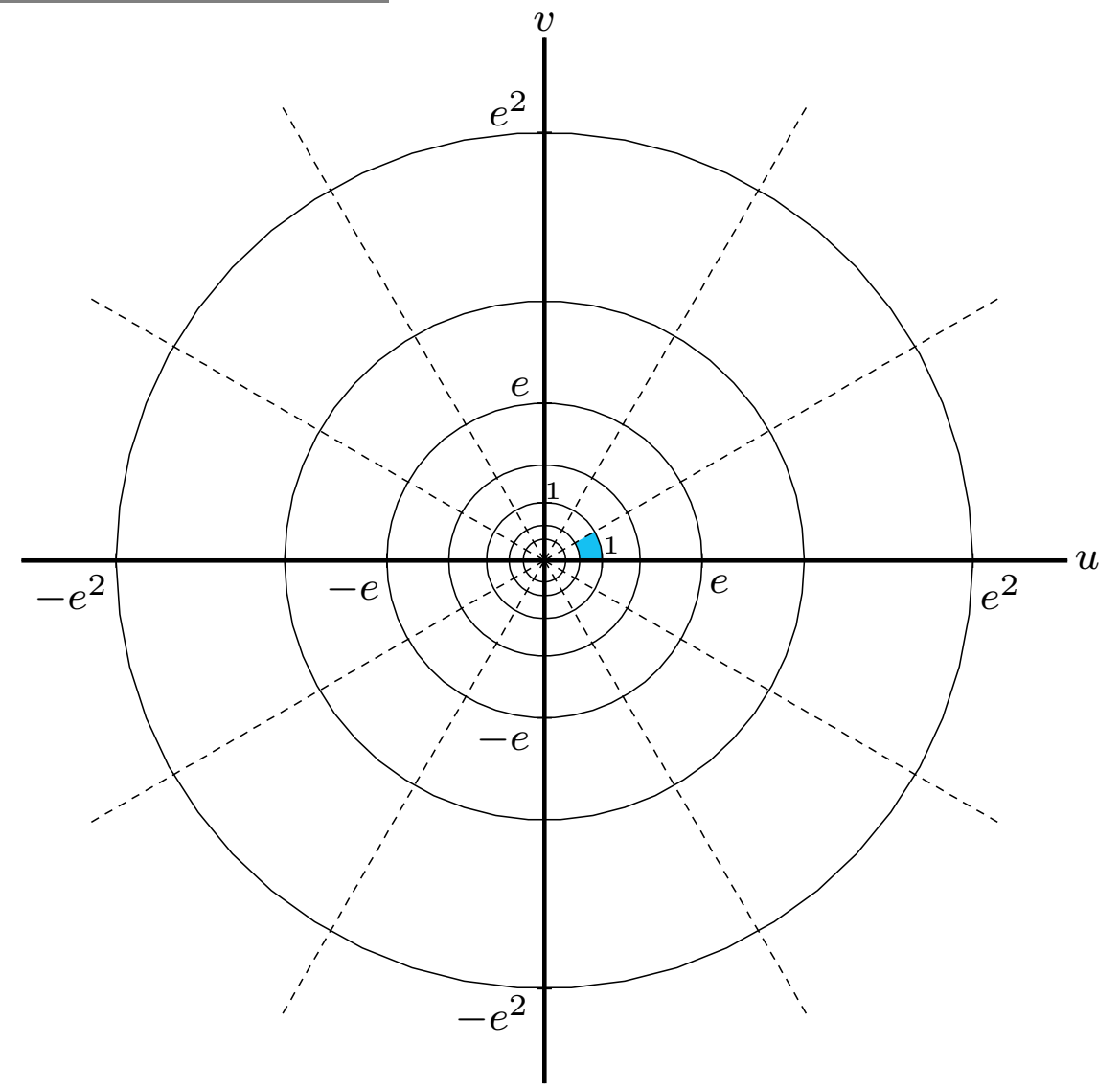
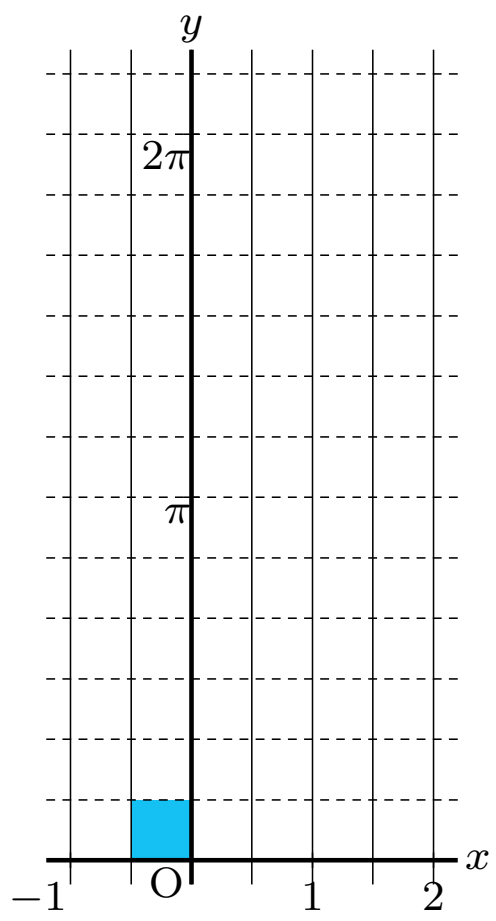

End

$w = e^z$ z -plane \longrightarrow w -plane

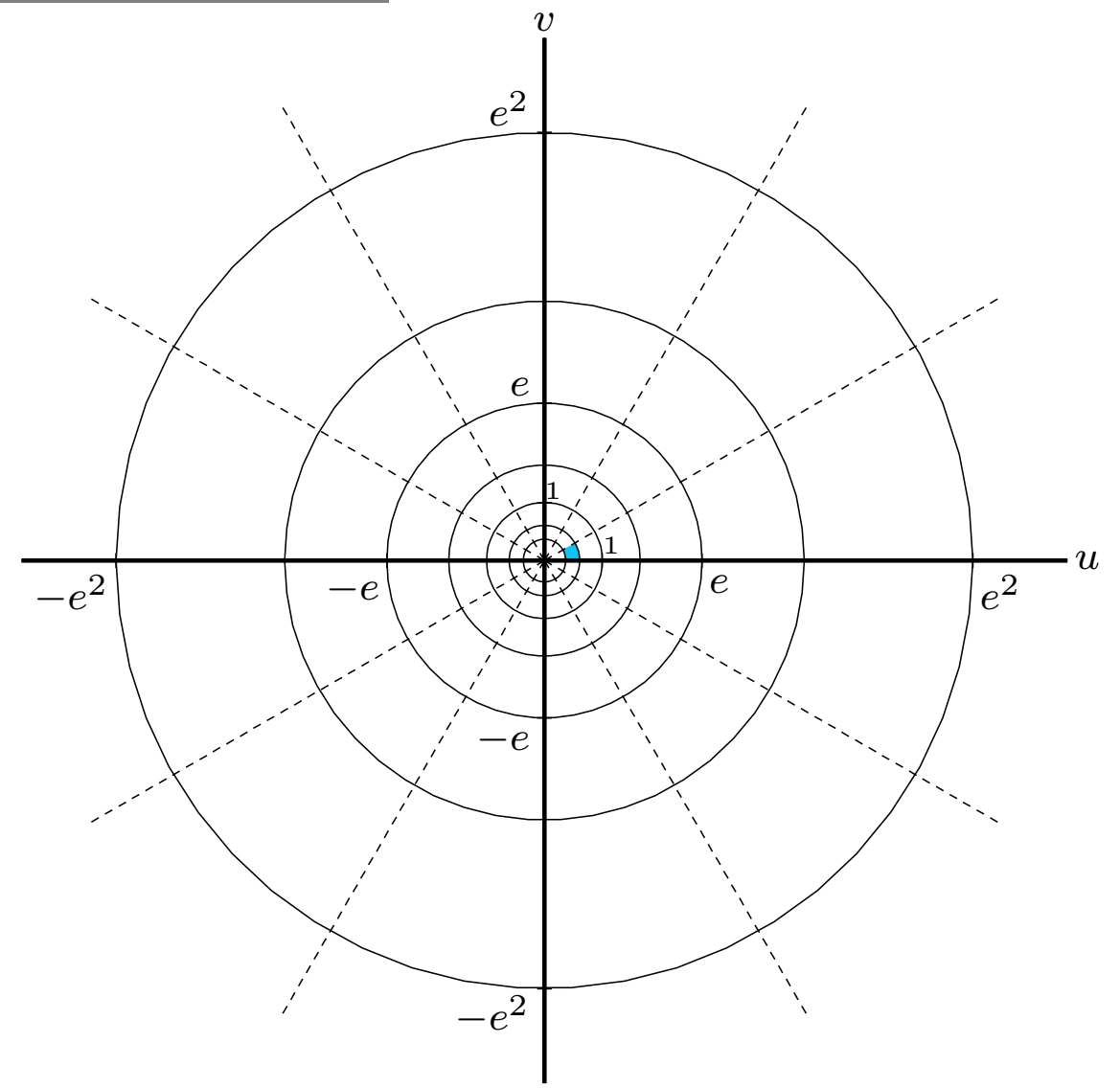
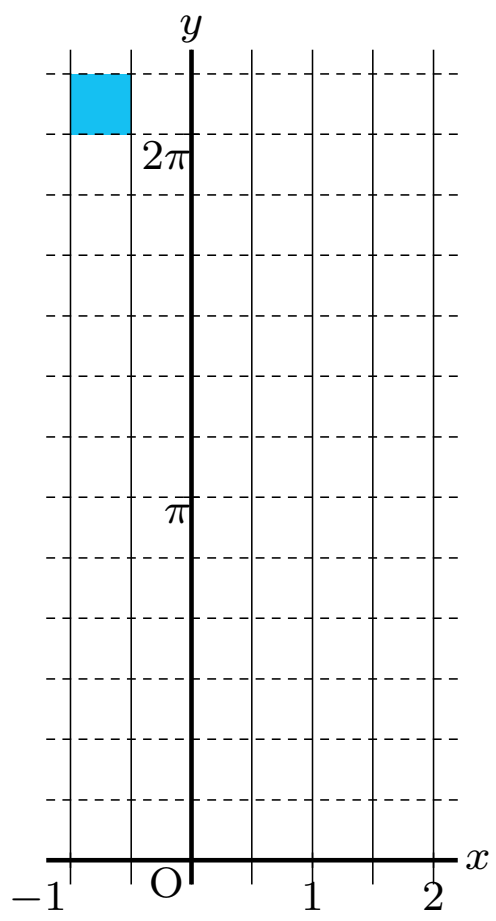

End

$w = e^z$ z -plane \longrightarrow w -plane

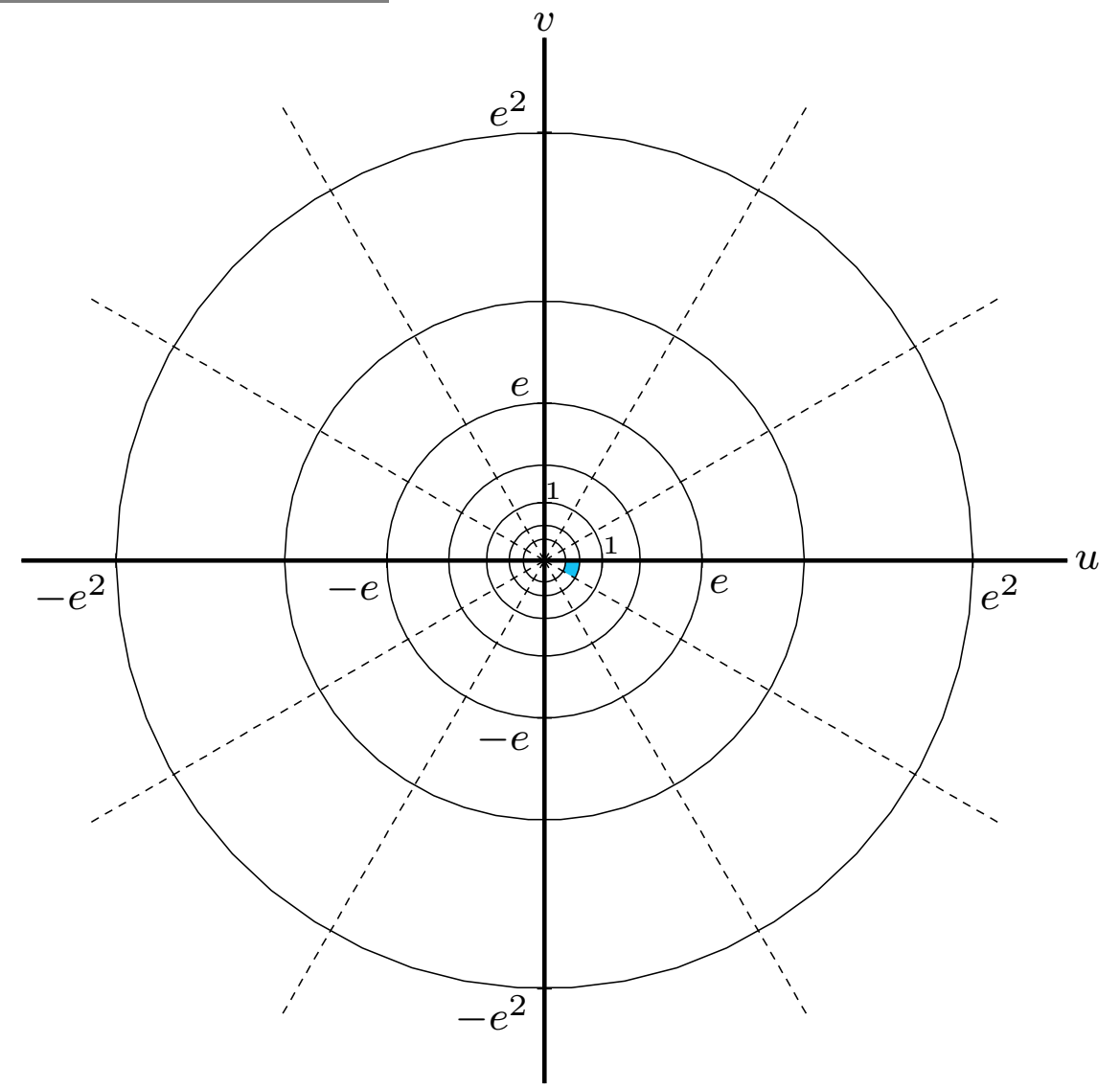
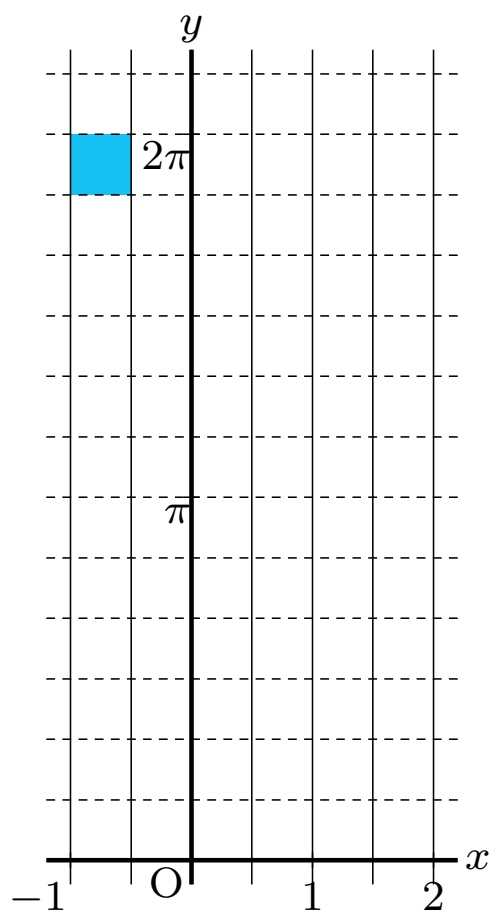

End

$w = e^z$ z -plane \longrightarrow w -plane

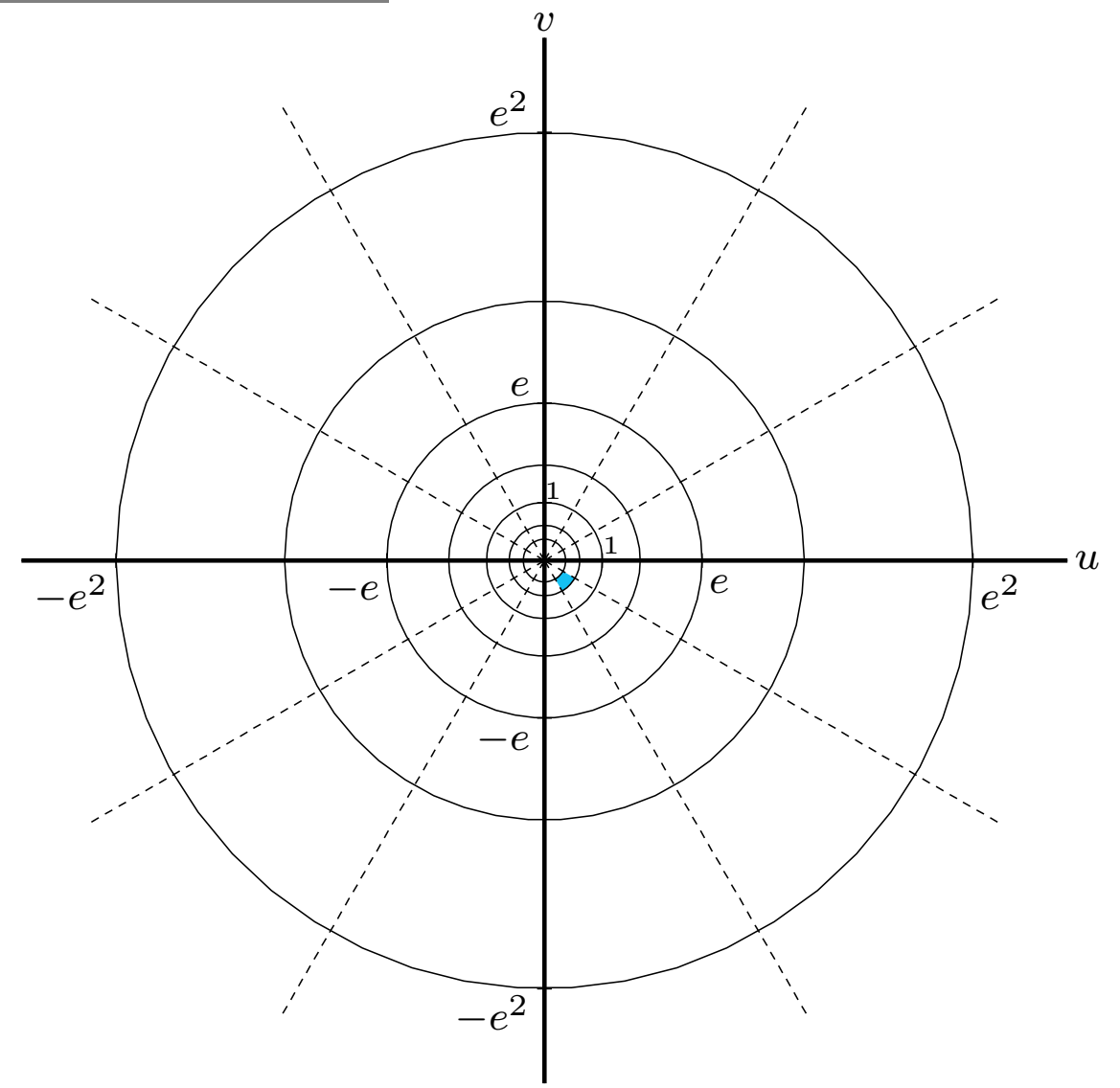
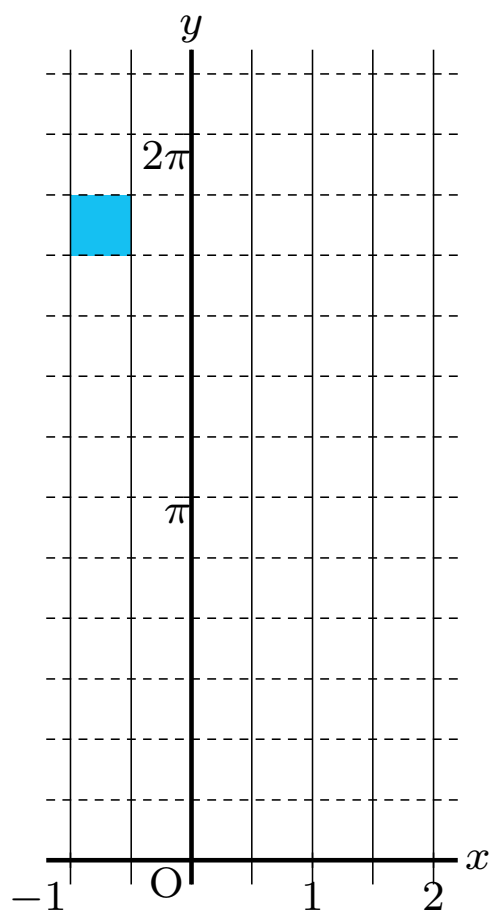

End

$w = e^z$ z -plane \longrightarrow w -plane

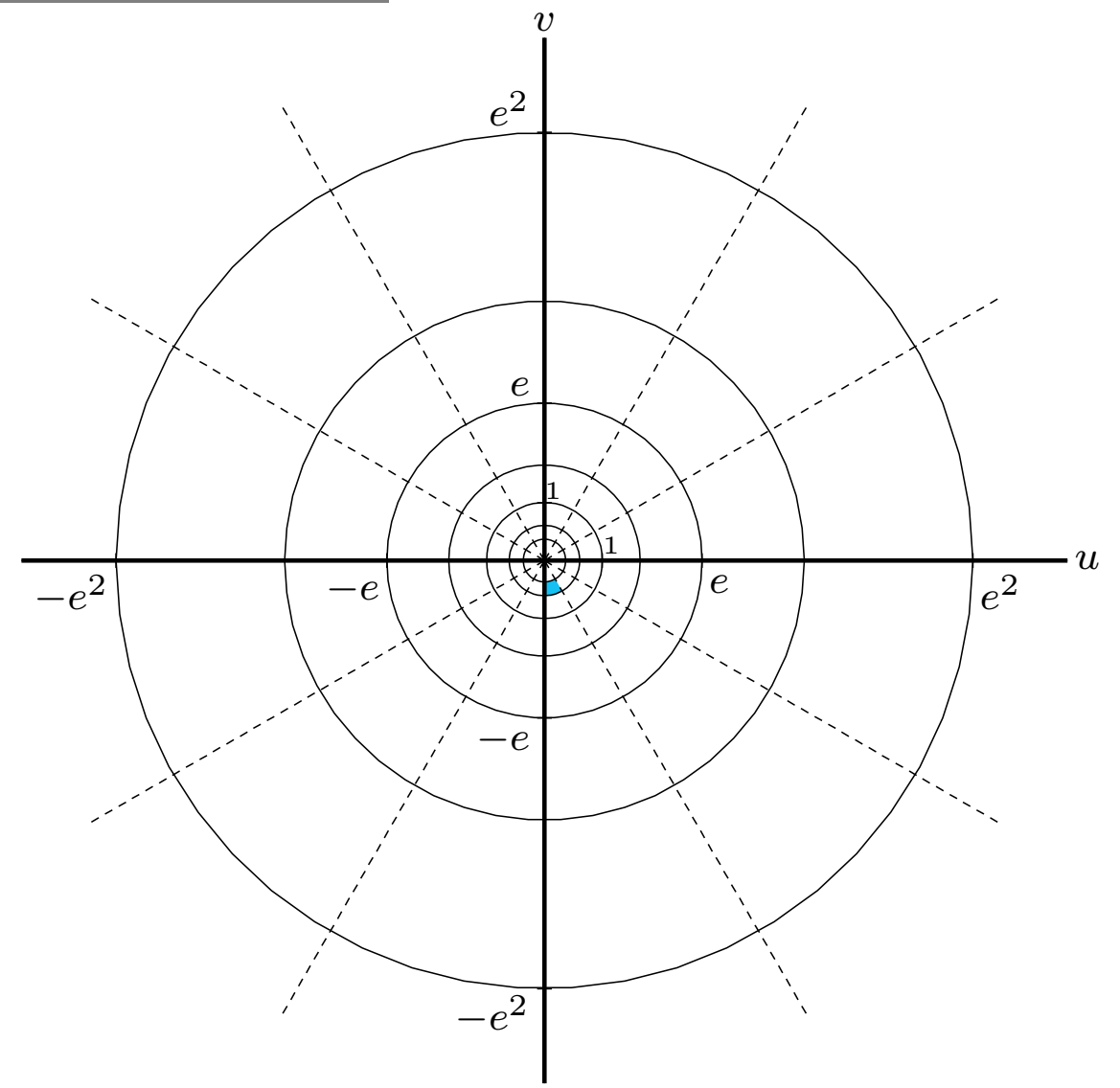
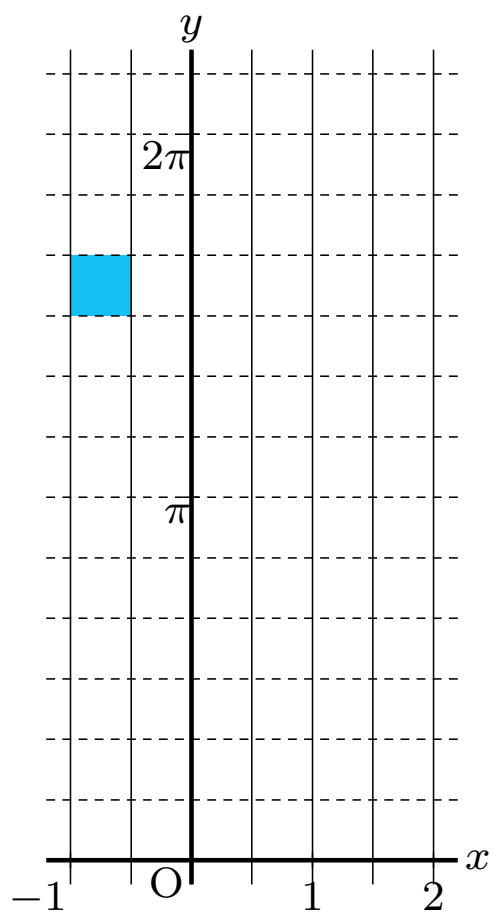

End

$w = e^z$ z -plane \longrightarrow w -plane

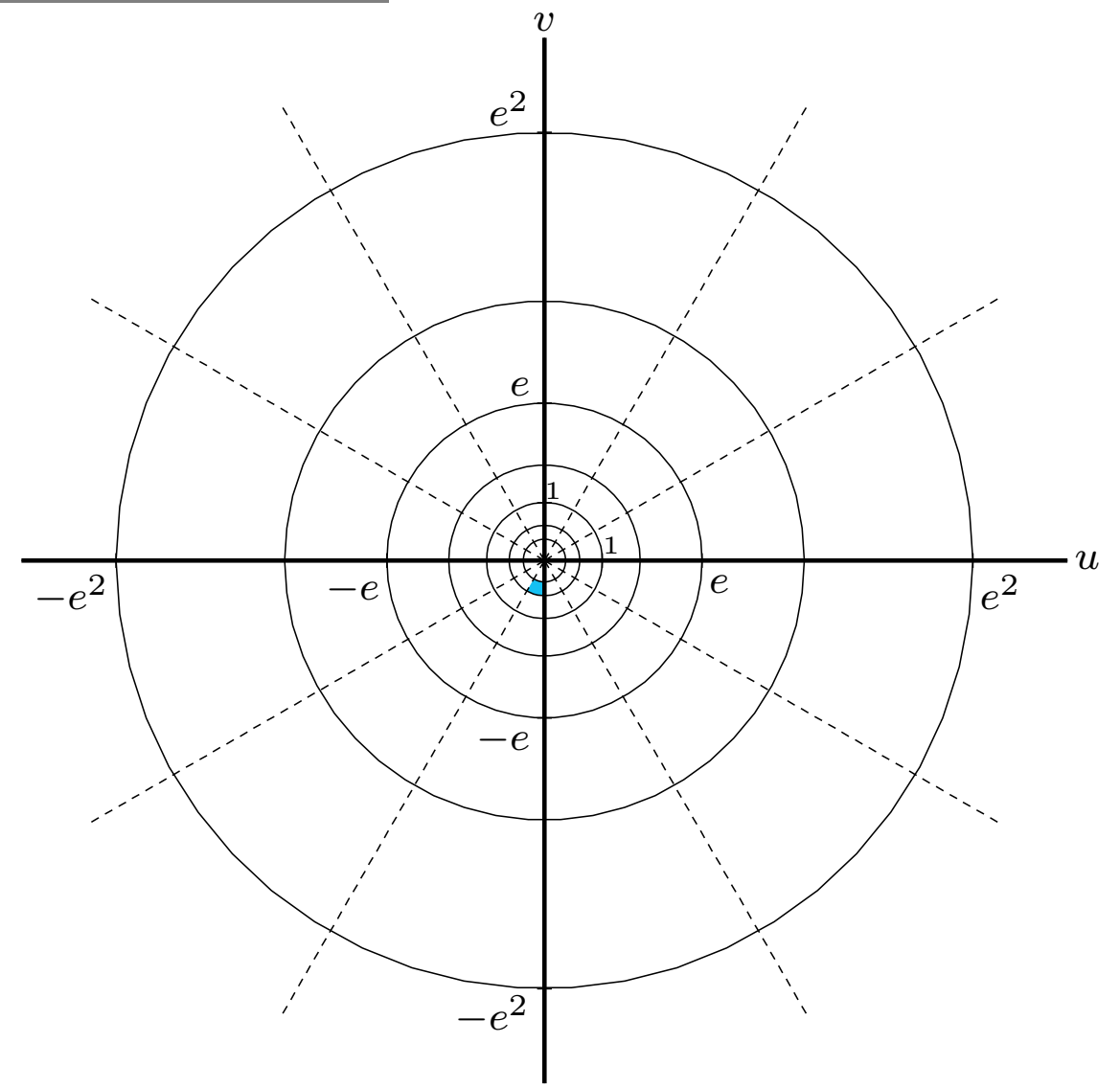
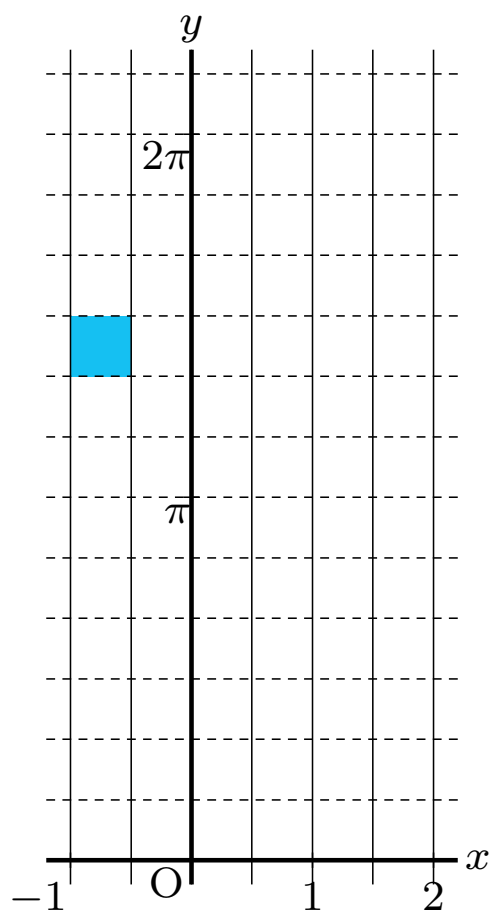

End

$w = e^z$ z -plane \longrightarrow w -plane

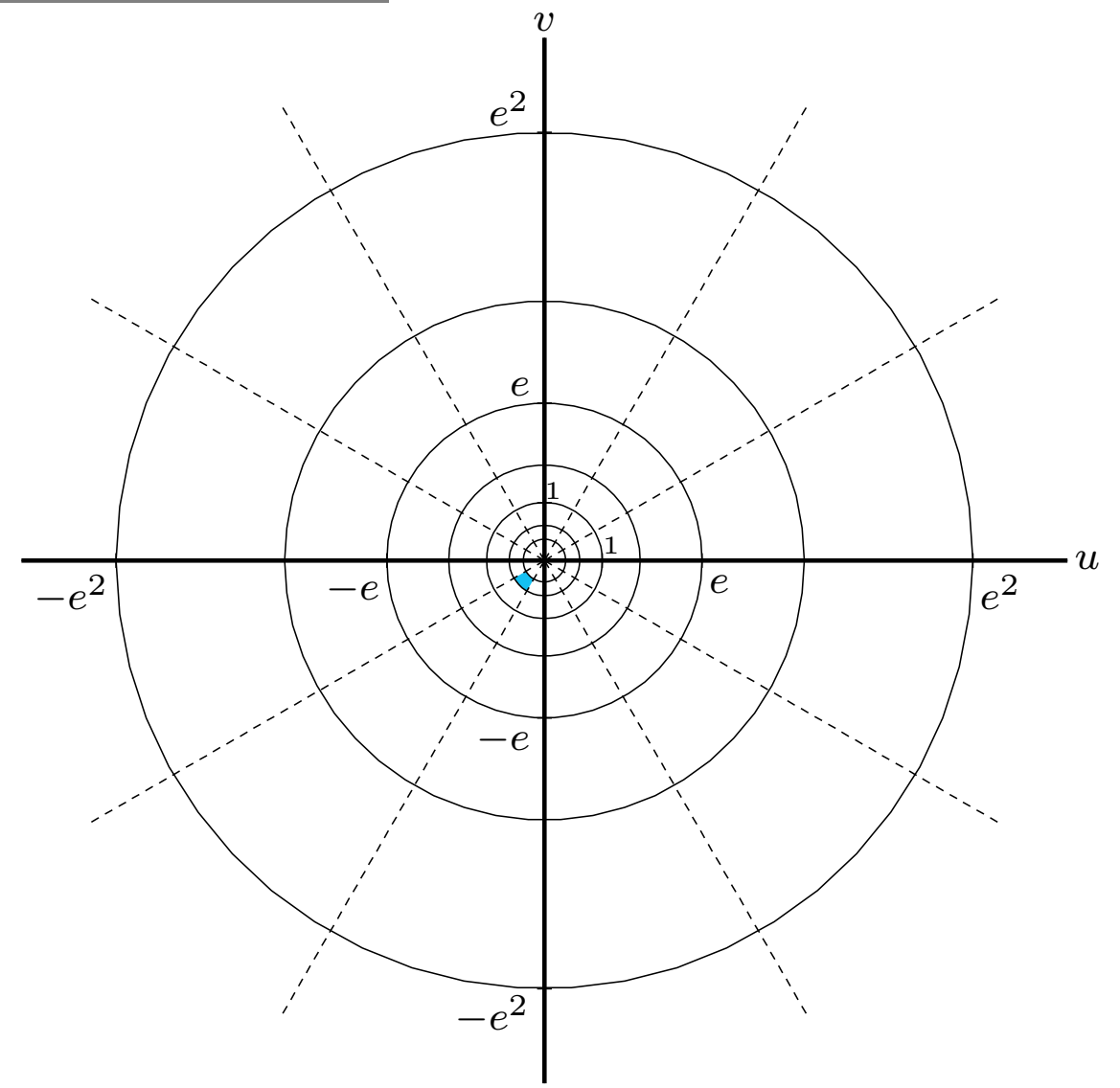
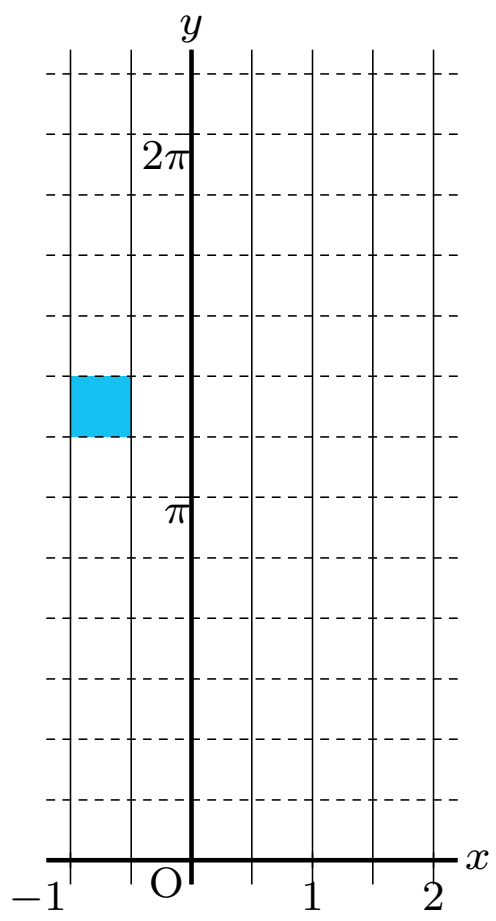

End

$w = e^z$ z -plane \longrightarrow w -plane

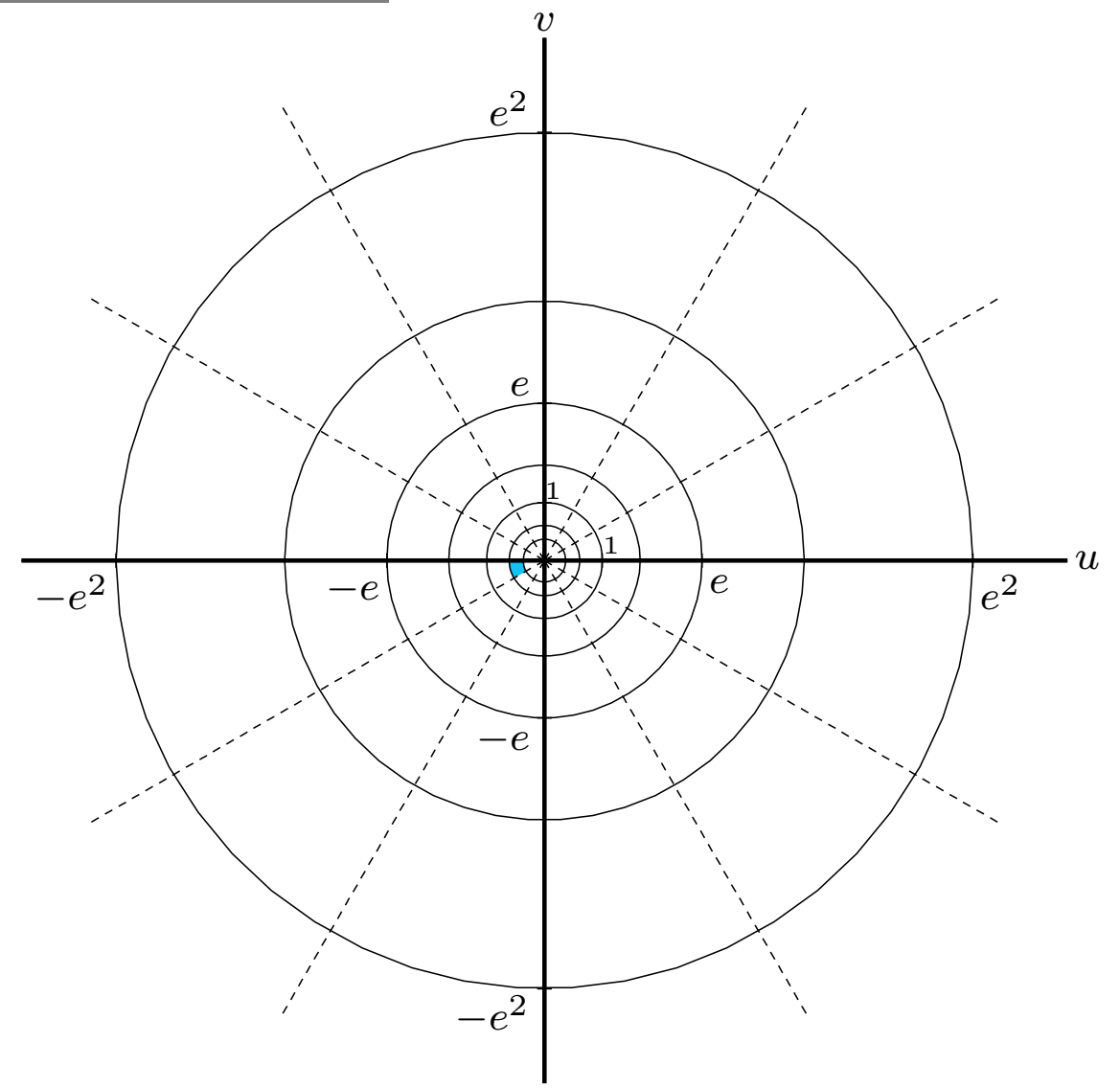
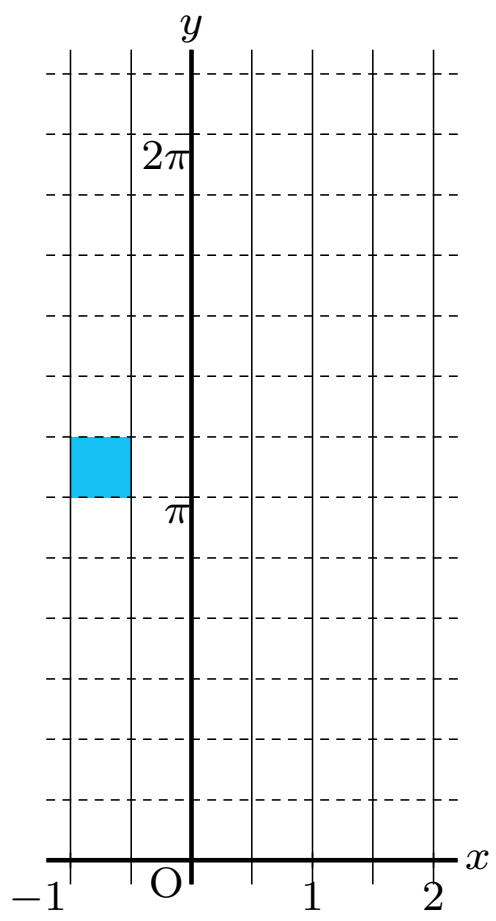

End

$w = e^z$ z -plane \longrightarrow w -plane

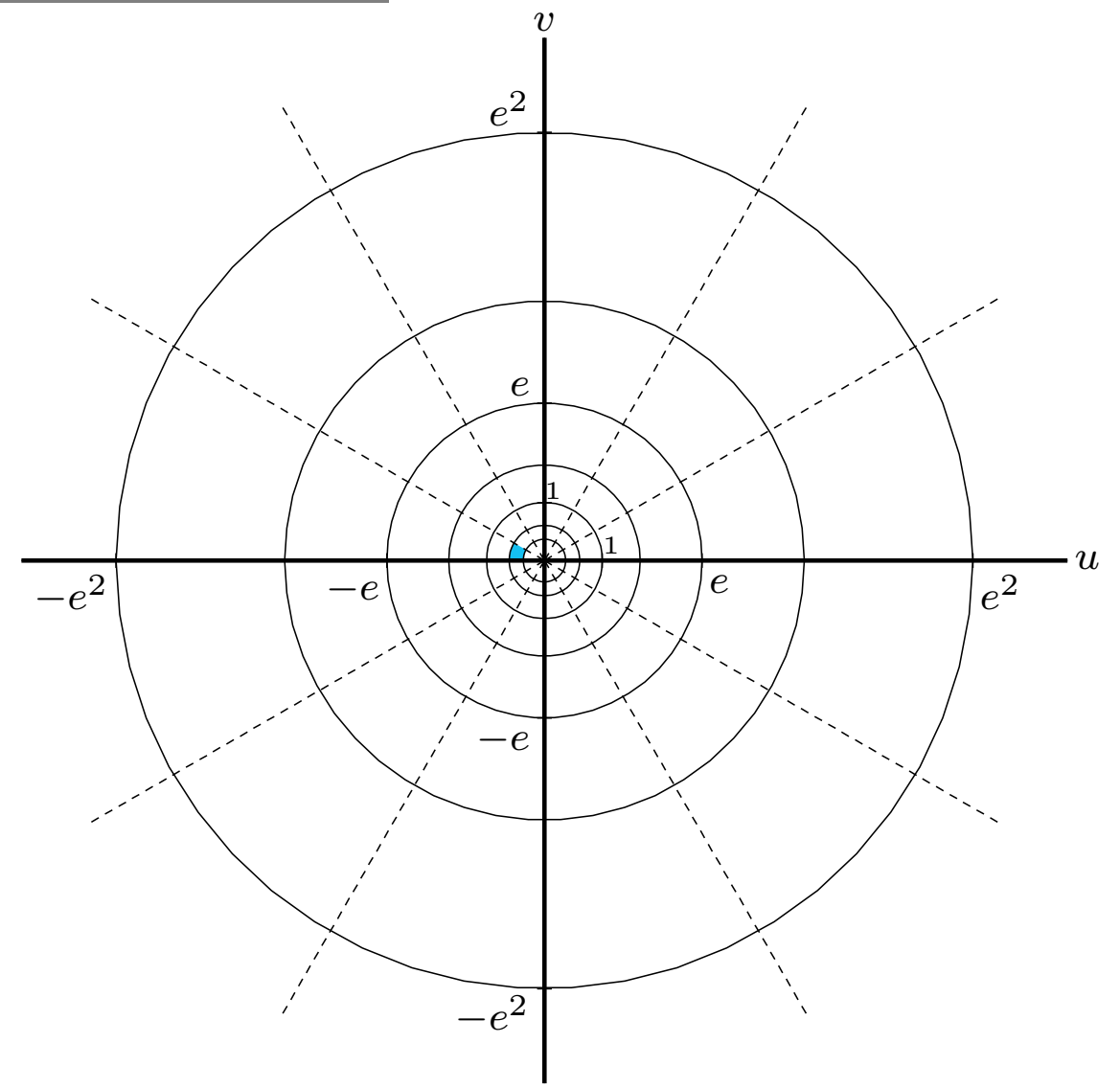
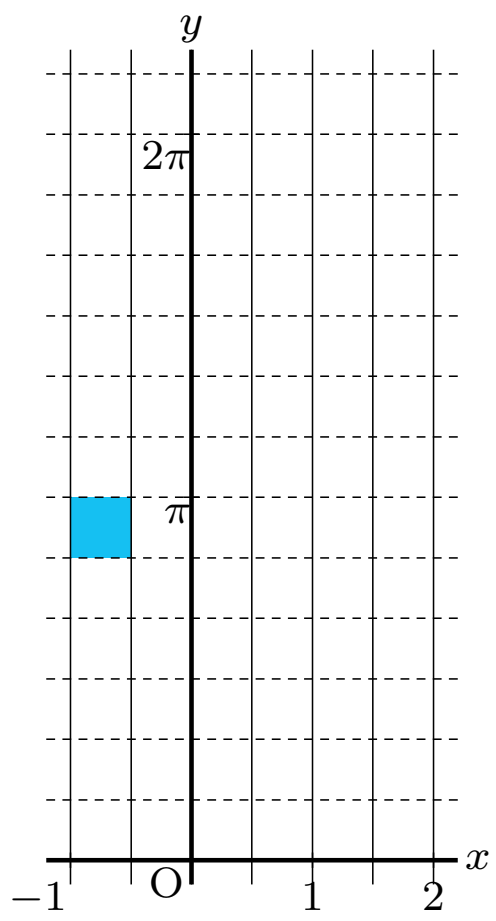

End

$w = e^z$ z -plane \longrightarrow w -plane

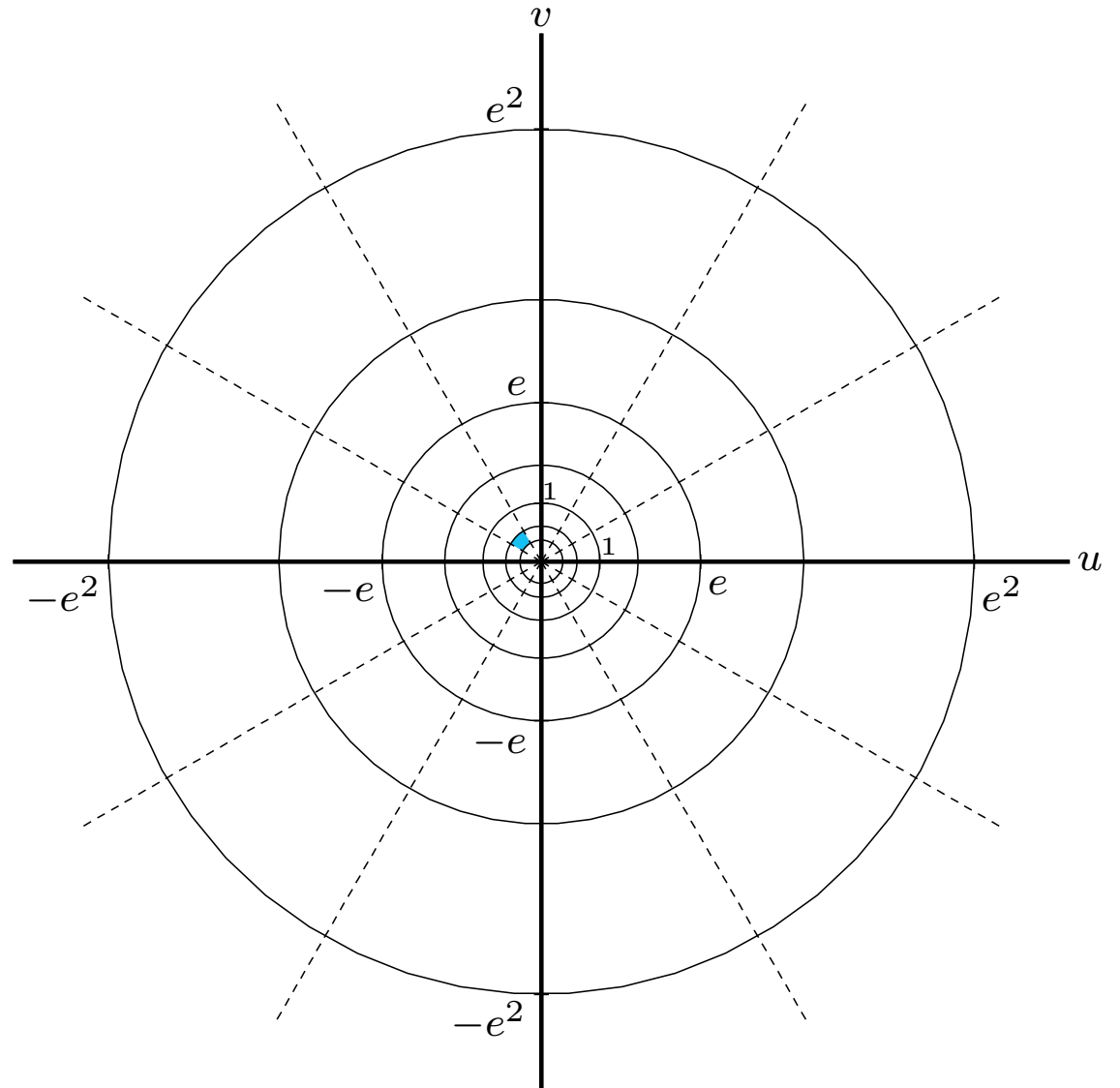
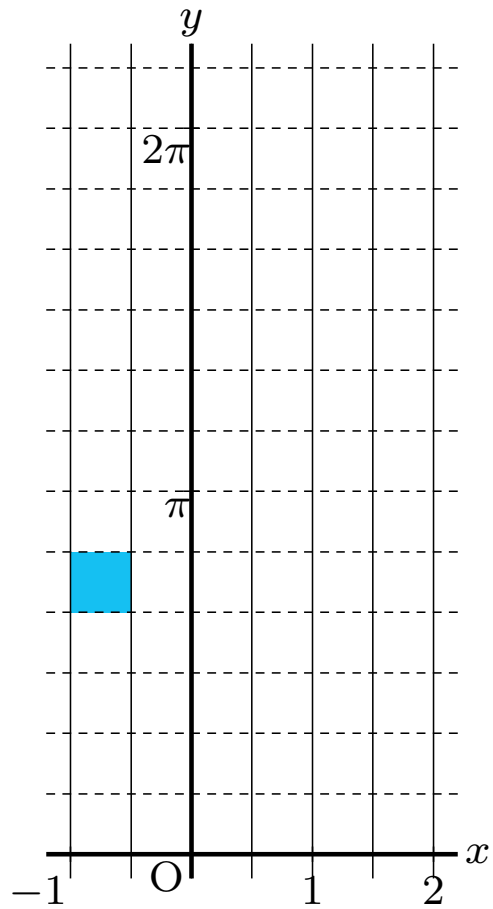

End

$w = e^z$ z -plane \longrightarrow w -plane

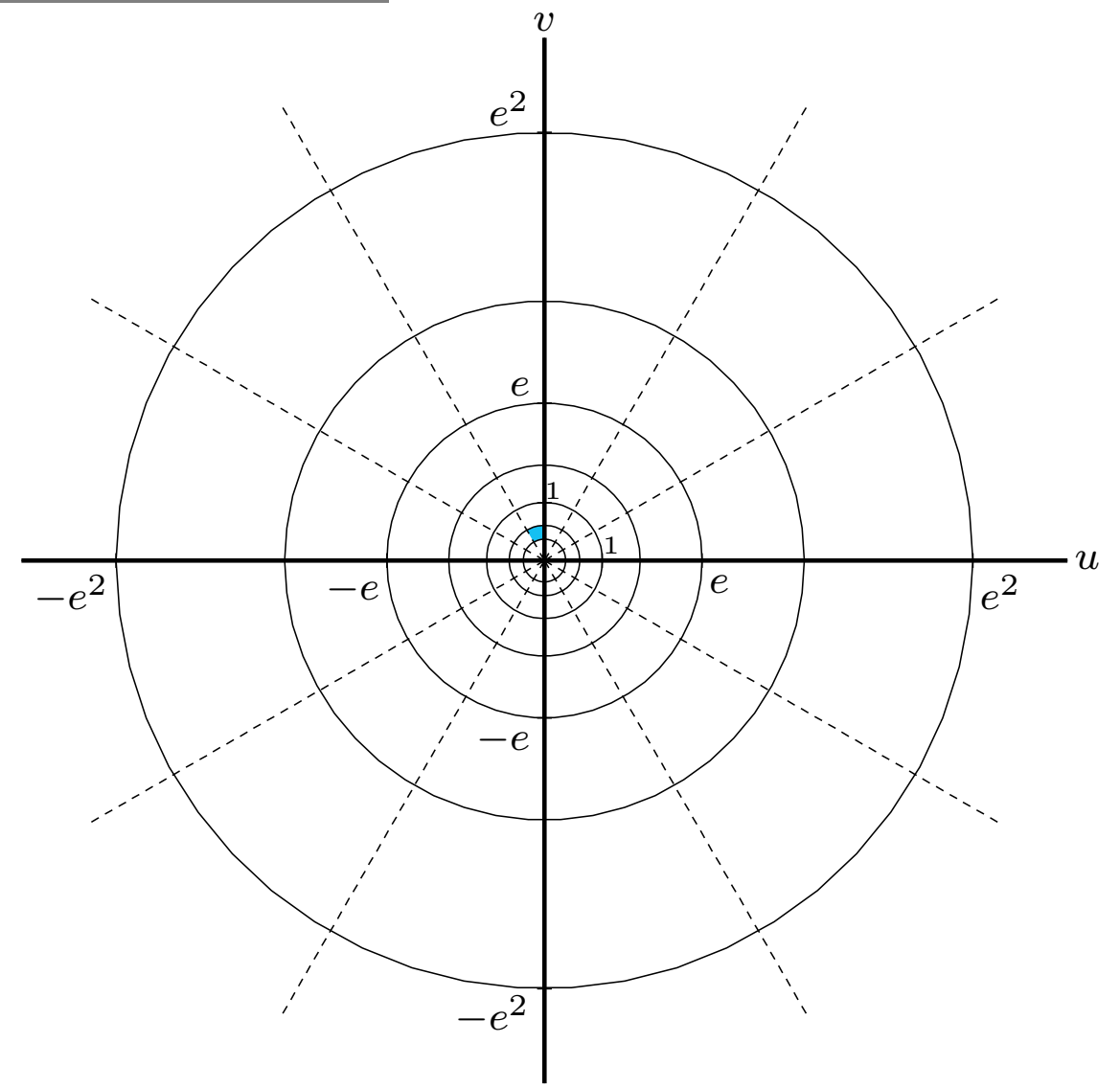
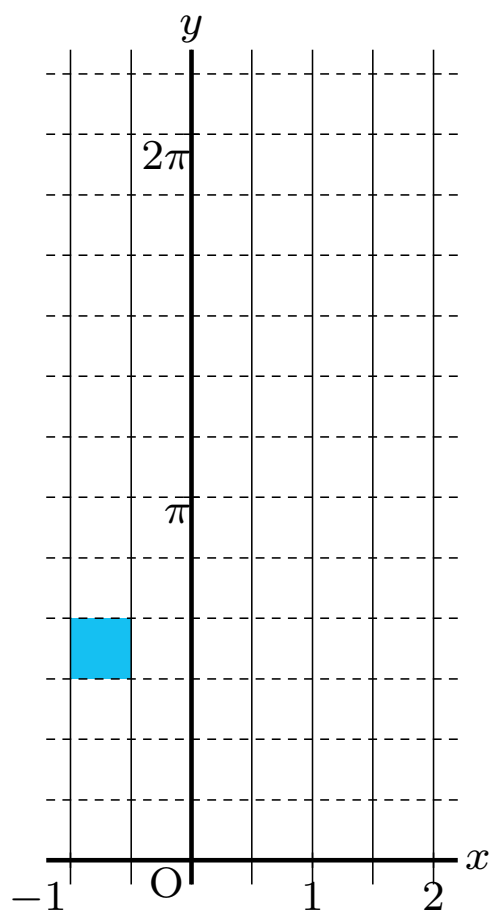

End

$w = e^z$ z -plane \longrightarrow w -plane

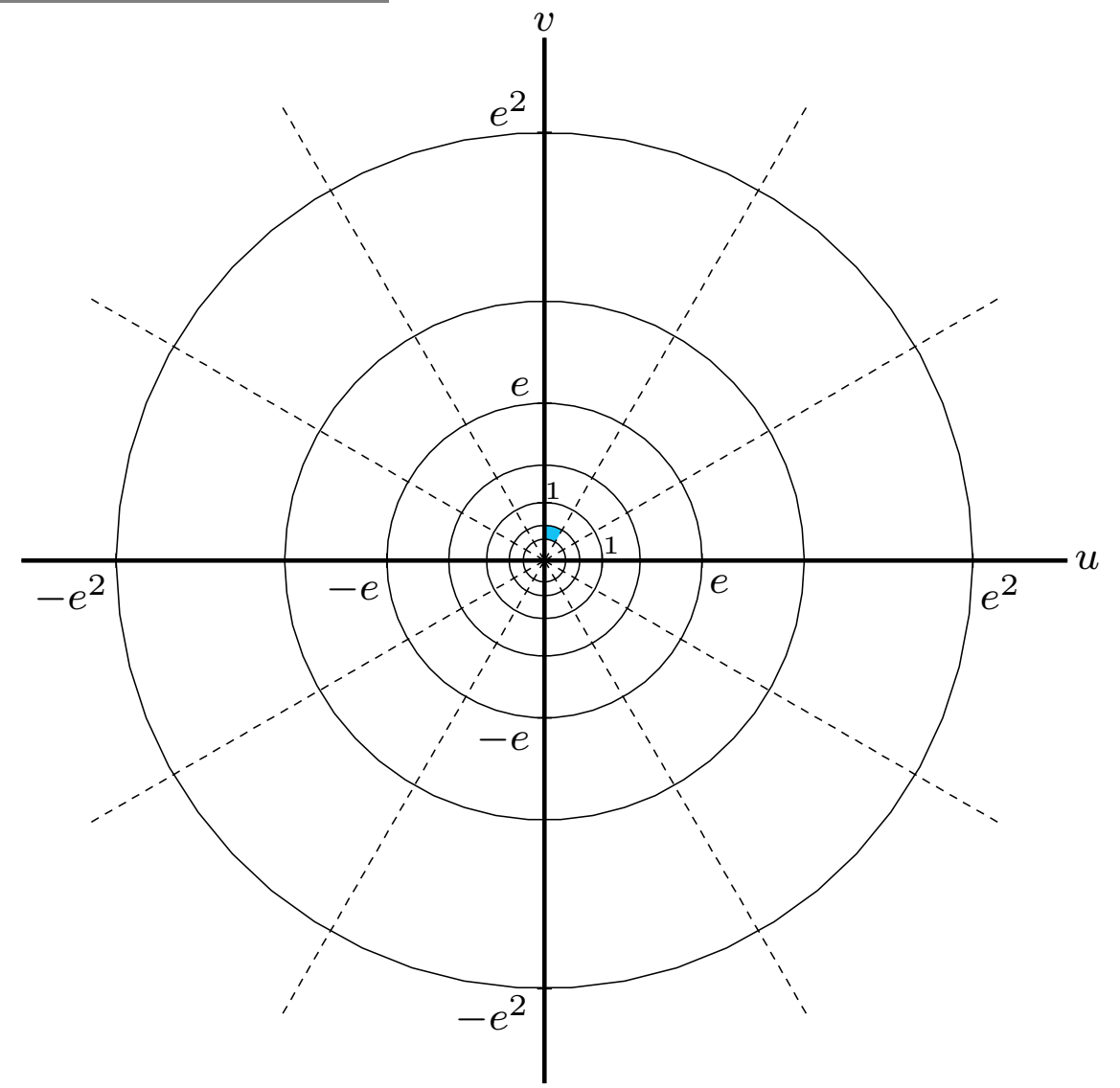
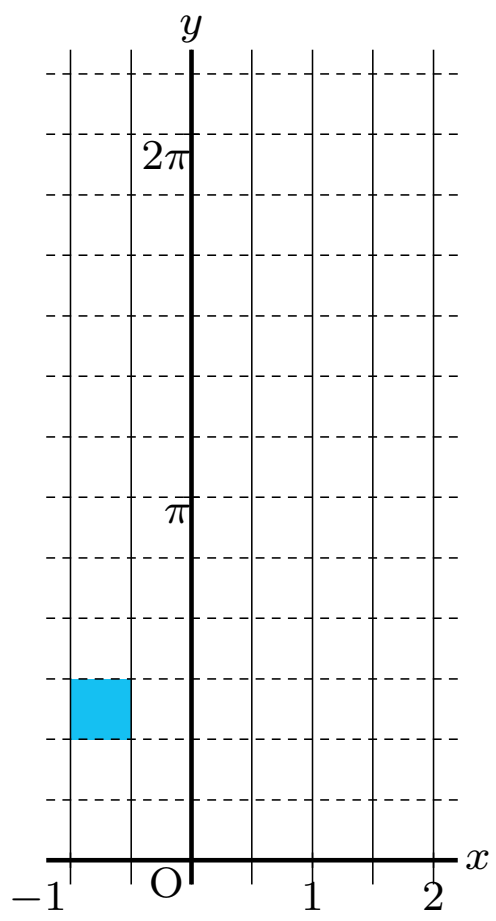

End

$w = e^z$ z -plane \longrightarrow w -plane

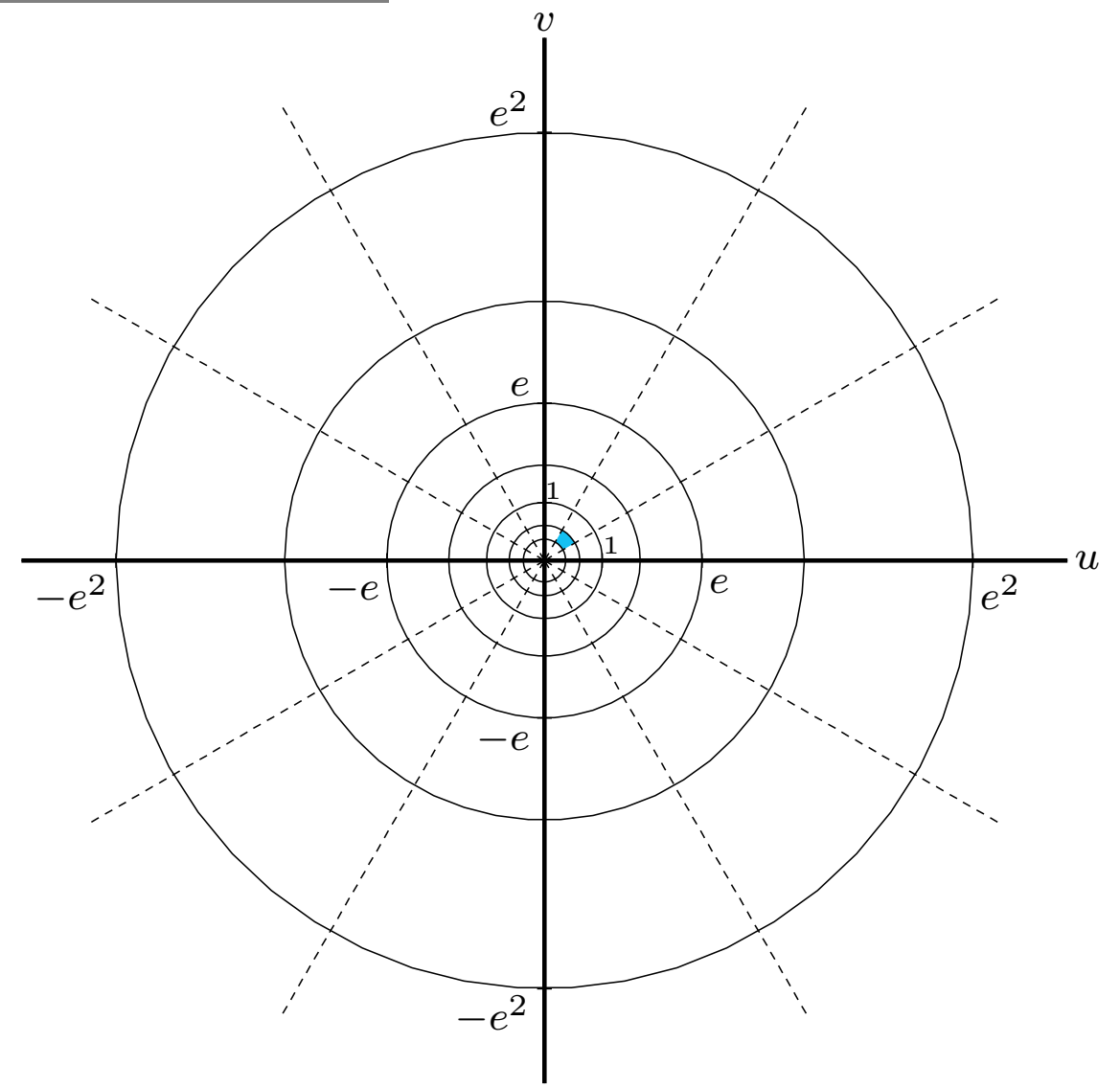
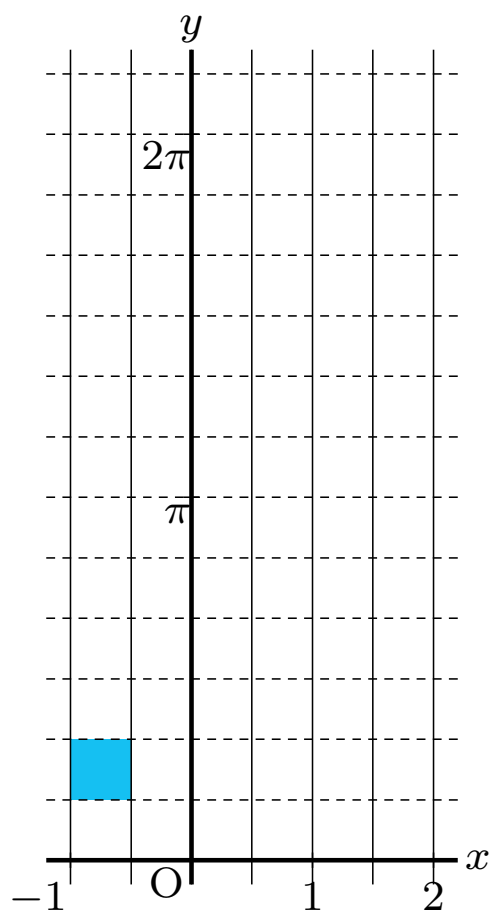

End

$w = e^z$ z -plane \longrightarrow w -plane

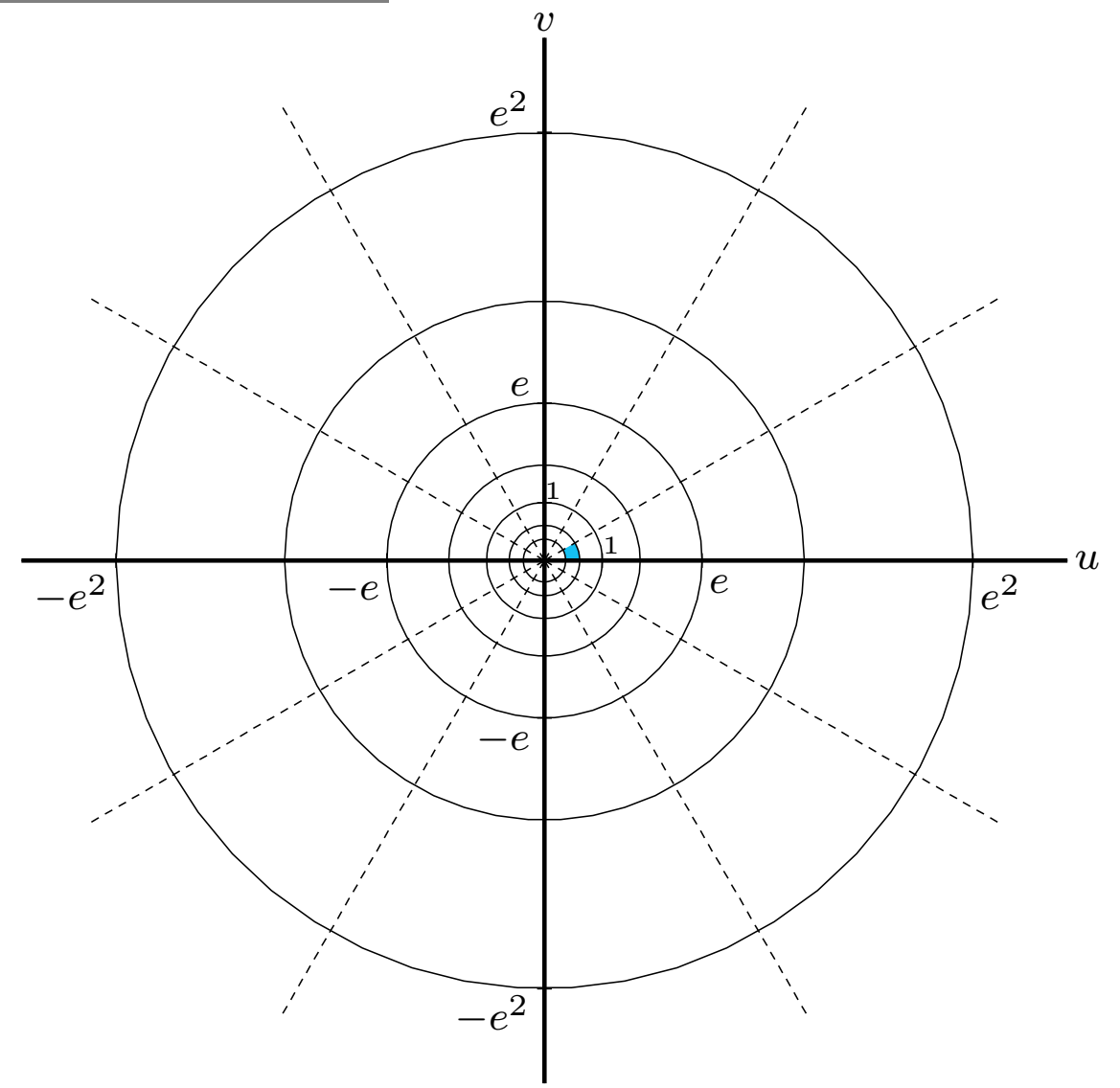
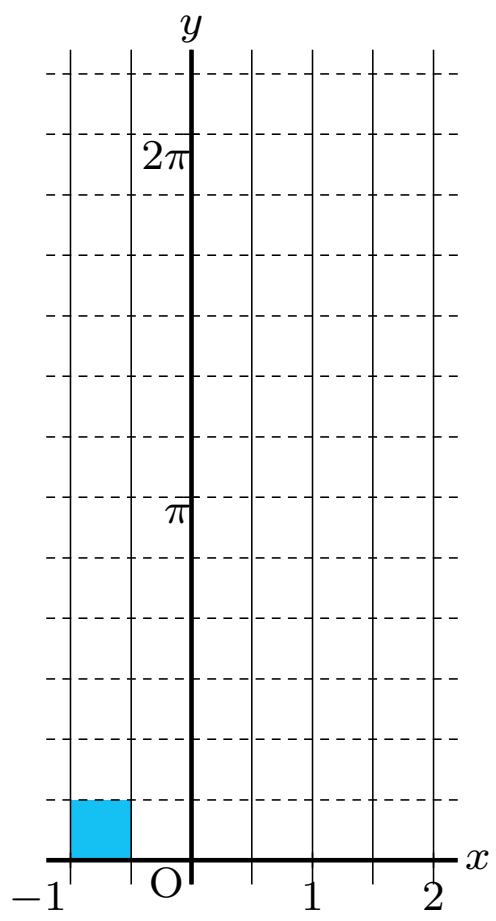

End